



DrufelCNC NVCM5 V2.1 5 AXIS (Novusun) Installation Manual



DrufelCNC, 2021

Contents

Annotation	4
NOTICE OF LIABILITY.....	5
1. Features.....	6
2. Appearance.....	7
3. Product connection define and method	8
4. Basic connection diagram.....	15
5. Connection diagram stepper motors and spindle	16
6. Connection diagram input ports.....	17
7. Connection diagram MPG	18
8. Installing DrufelCNC.....	19
9. DrufelCNC interface.....	25
10. Run the program	29
11. Customization	30
11.1. Common	30
11.2. Controller Configuration.....	31
11.3. Axis Setup	32
11.3.1. Calibrate axis	33
11.4. Configure Input Ports	35
11.4.1. Input port diagnostics	35
11.4.2. Hot keys	37
11.5. Configuring output ports	39
11.6. Spindle adjustment.....	40
11.7. Machine size	42
11.7.1. Size axis	43
11.7.2. Soft limit	43
11.7.3. Home function	45
12. Run the control program (G-code)	46
13. Search tool zero.....	47
14. Manual control	48
15. Spindle control and cooling	49
16. Assignment of coordinates	50
16.1. Measurement system	51
16.2. Machine coordinates	52
16.3. Work coordinates.....	52
17. Display 3D model.....	53

18. Opening HPGL files	54
19. Basic parameters of the HPGL file converter	55
19.1. Spindle settings of HPGL file converter	56
19.2. Use step by step	57
20. Generating a G-code from an image	58
21. Stepper motors	60

Annotation

This document is the user guide for the DrufelCNC software. The information contained in this document may be modified by employees of the company with the subsequent notification. Your changes are reflected in the document version. The company does not guarantee the absence of errors or typographical errors in this document, but will work to eliminate them, and will also be grateful to everyone who finds them and points to them.

Comments and suggestions to this document are accepted by email: social@drufelcnc.com. Document version - V.1.17.

NOTICE OF LIABILITY

Using any CNC machine is a dangerous operation. All precautions must be taken, as the machines may turn on at any time, the software MAY malfunction at any time, any user of the Software must understand and take this into account, and must immediately uninstall the Software and not proceed with the installation if they are not fully understand all the consequences of the use, as well as the fact that in case of misuse, the wrong code, unexpected movement or any damage caused by the aforementioned consequences mi, there is no legal protection.

1. Features

- Support 5-axis CNC control.
- 16 input interface.
- 16 output interface.
- 1 port 0-10V spindle speed analog output interface (can change to PWM output).
- Main device is 12V-32VDC power supply input,current should higher than 1A.
- ARM motion control chip.
- Support USB.

2. Appearance

NVCM motion controller is with the sealed open structure, there are 4pcs setting holes at the bottom. You can fix 2pcs 3mm diameter holes at the cabinet, and install the controller into the cabinet.

The products overall size is 150mm*84mm*20mm.

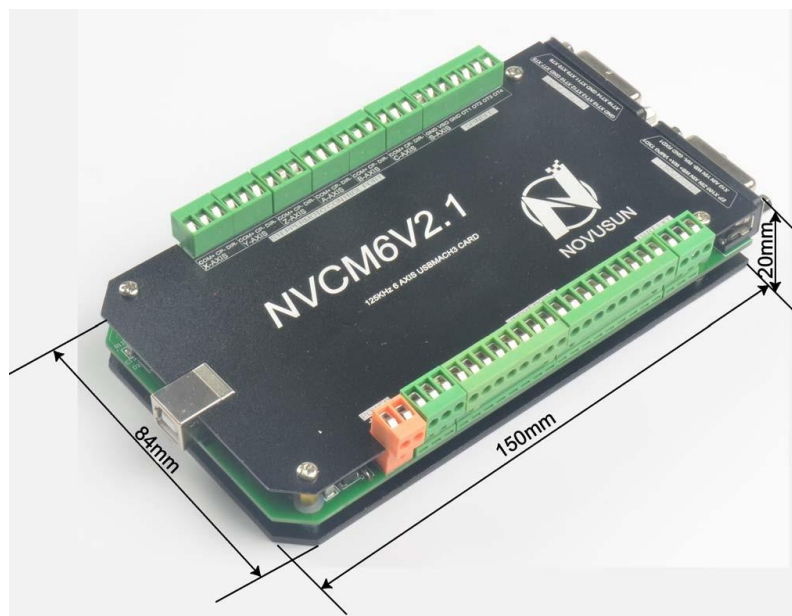

The bottom install size is 125.5mm*71.5mm.



3. Product connection define and method

The controller connection includes a power supply interface, a USB connection interface, an MPG interface, a Stepper / Servo control output interface, a spindle control output interface, Estop and a limited switch input and tool settings interface and so on.



- 1 - USB Port.
- 2 - Main power Interface.
- 3 - Input interface.

Estop limited Tool setting input interface

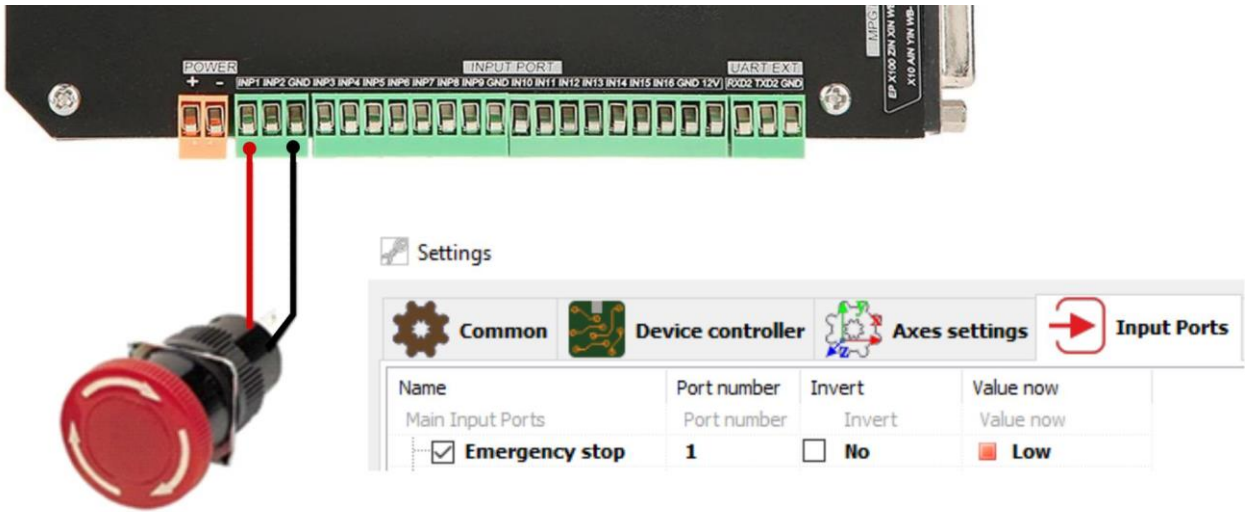

Probe input connection

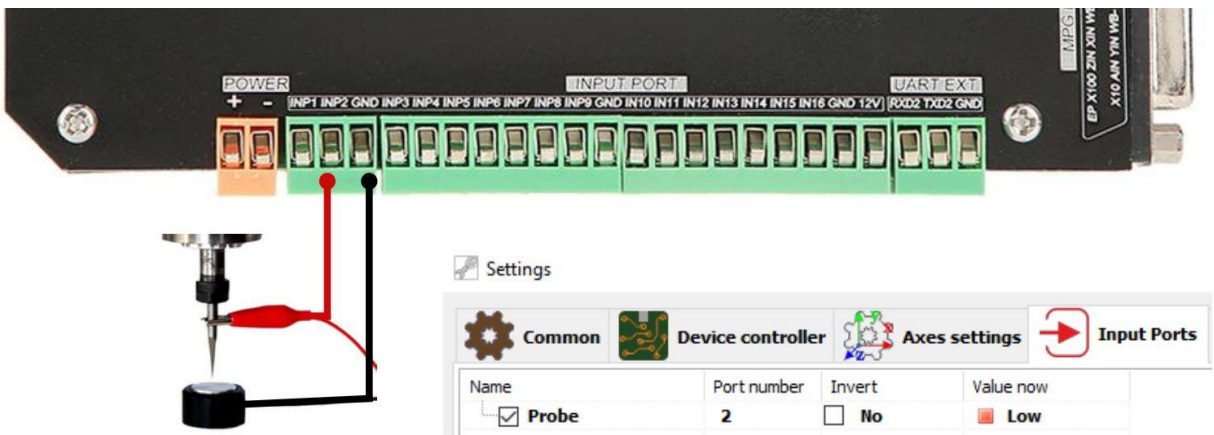

End switch input connection

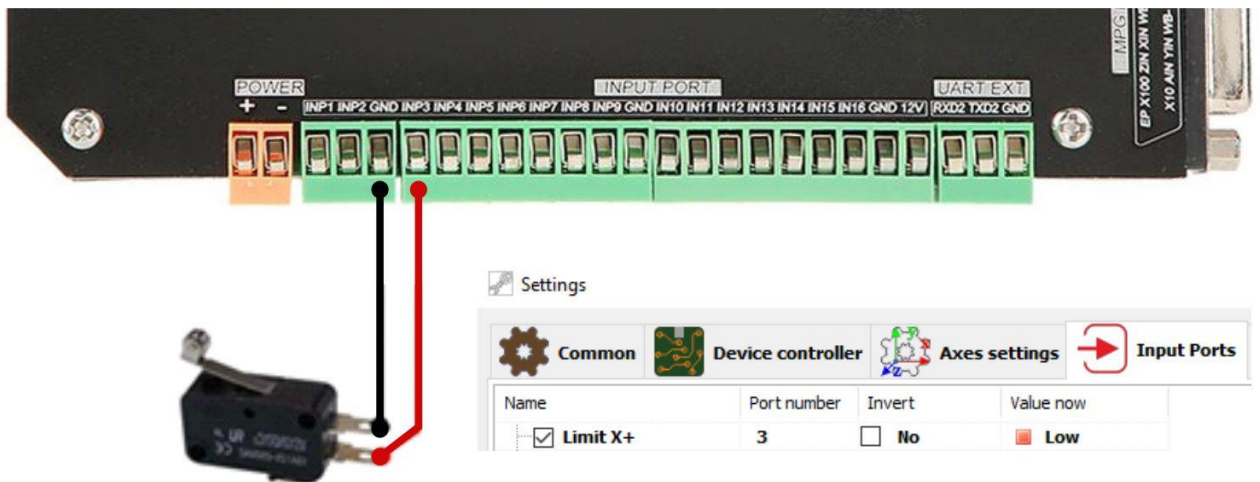

4 - Communication external interface.

5 - MPG connection.

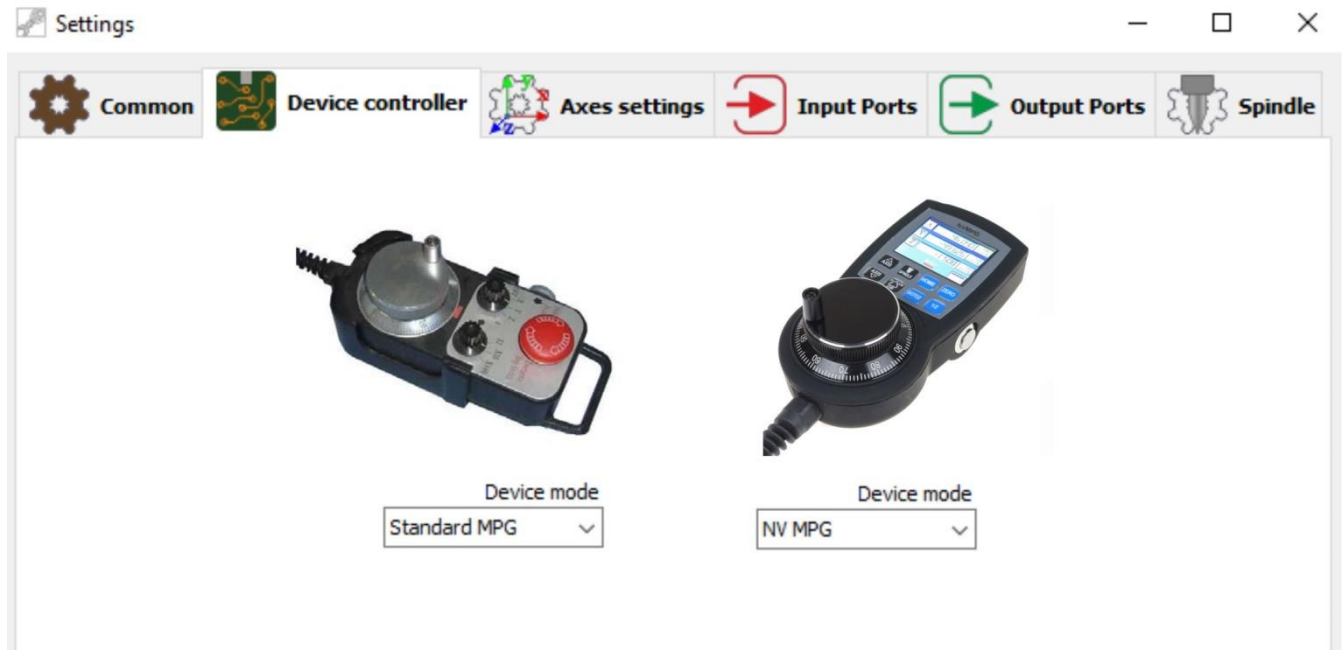

Pin mark	Definition	Notes
GND	MPG Ground	MPG power supply GND.
TXD	MPG serial communication Output Port	For the digital display MGP communication
RXD	MPG serial communication input Port	For the digital display MPG communication
100X	100X multiplication switch	Short connect with GND means 100X multiplication, cutoff means no pulse
10X	10X multiplication switch	Short connect with GND means 10X multiplication, cutoff means no pulse

1X	1 X multiplication switch	Short connect with GND means 1X multiplication, cutoff means no pulse
ESTOP	MPG Estop	Short connect with GND means Estop effective, cutoff show invalid
C-IN	C Axis selected switch	Short connect with GND means selecting C axis, cutoff means don't select
B-IN	B Axis selected switch	Short connect with GND means selecting B axis, cutoff means don't select
A-IN	A Axis selected switch	Short connect with GND means selecting A axis, cutoff means don't select
Z-IN	Z Axis selected switch	Short connect with GND means selecting Z axis, cutoff means don't select
Y-IN	Y Axis selected switch	Short connect with GND means selecting Y axis, cutoff means don't select
X-IN	X Axis selected switch	Short connect with GND means selecting X axis, cutoff means don't select
VDD5	MPG power supply 5V	MPG power supply 5V

	Output	output
WHA+	MPG A Phases Positive	MPG A Phase differential Input Positive
WHB+	MPG B Phases Positive	MPG B Phase differential Input Positive
WHA-	MPG A Phases Negative	MPG A Phase differential Input Negative
WHB-	MPG B Phases Negative	MPG B Phase differential Input Negative

6 - Common IO output include OUT1, OUT2 on the spindle interface, totally 10 ports IO output, open drain output.

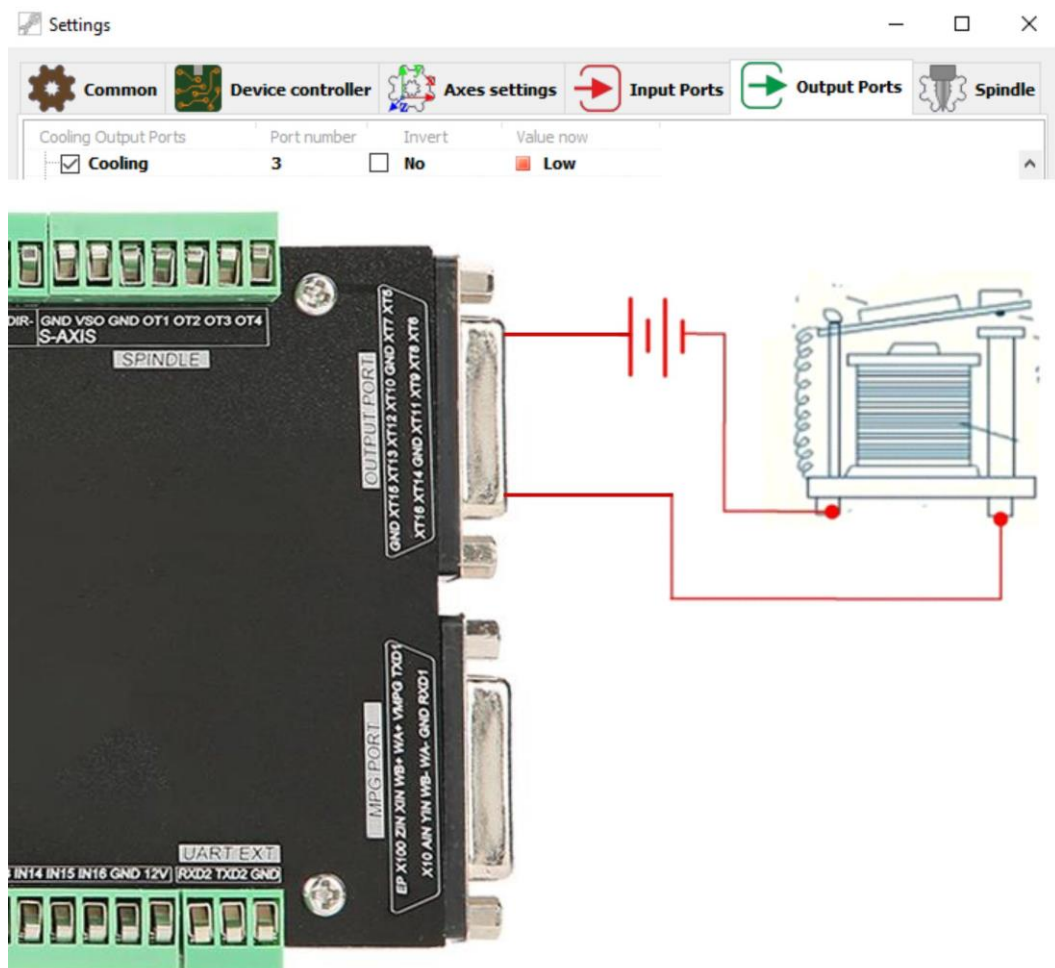

7 - Spindle control output. GND1 (Output GND), VSO (0-10V adjustable speed output), INDEX (spindle speed feedback input), OUT1 (common output port 1), OUT2 (common output port 2).

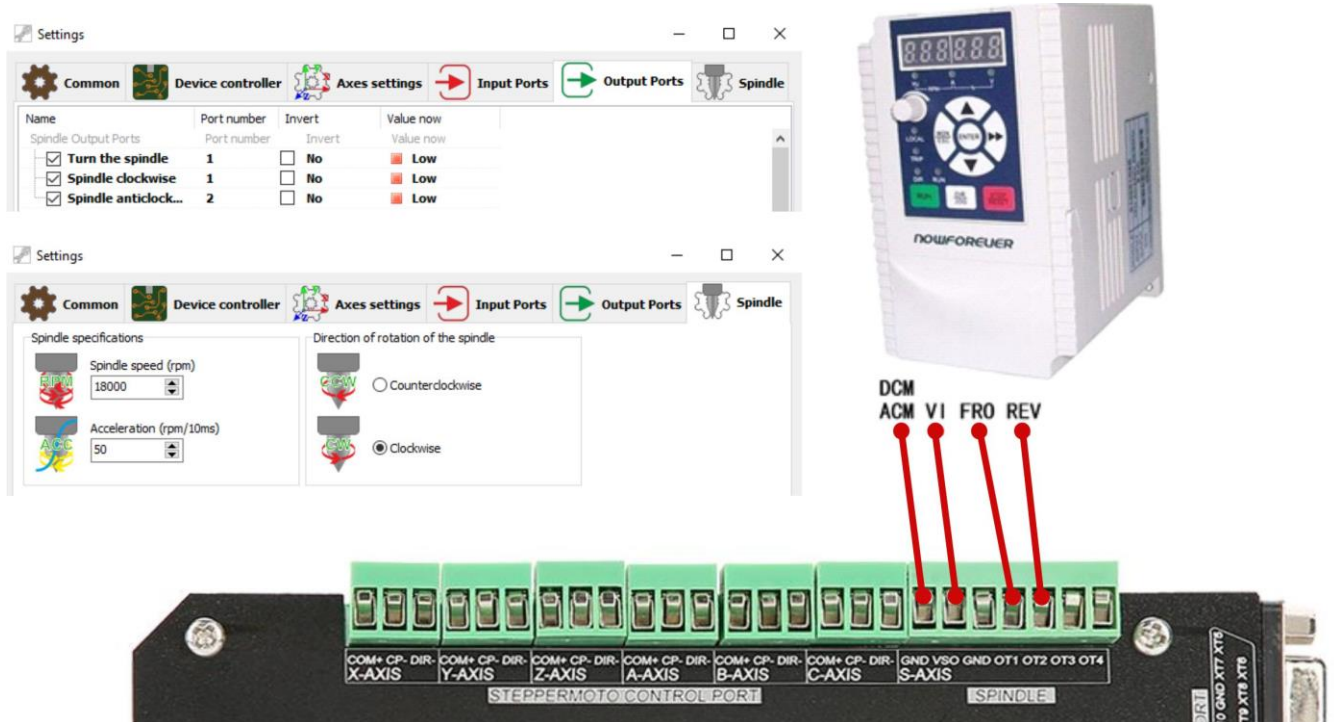

8 - Terminal block is 6 axis stepper driver control output interface, from left to right, there are X,Y,Z,A,B,C 6 axis output, it's common anode, the cable connection for each axis is COM+/CP-/DIR-, COM is common+ ,CP is Pulse-, DIR is direction-.

Pin mark	Axis	Definition
COM+	Common+	Common anode +5V
CPX-	X axis	Pulse output- for X axis
DIX-	X axis	Direction output- for X axis

CPY-	Y axis	Pulse output- for Y axis
DIY-	Y axis	Direction output- for Y axis
CPZ-	Z axis	Pulse output- for Z axis
DIZ-	Z axis	Direction output- for Z axis
CPA-	A axis	Pulse output- for A axis
DIA-	A axis	Direction output- for A axis
CPB-	B axis	Pulse output- for B axis
DIB-	B axis	Direction output- for B axis
CPC-	C axis	Pulse output- for C axis
DIC-	C axis	Direction output- for C axis

4. Basic connection diagram

DrufelCNC

Connection diagram NVCM5 of DrufelCNC

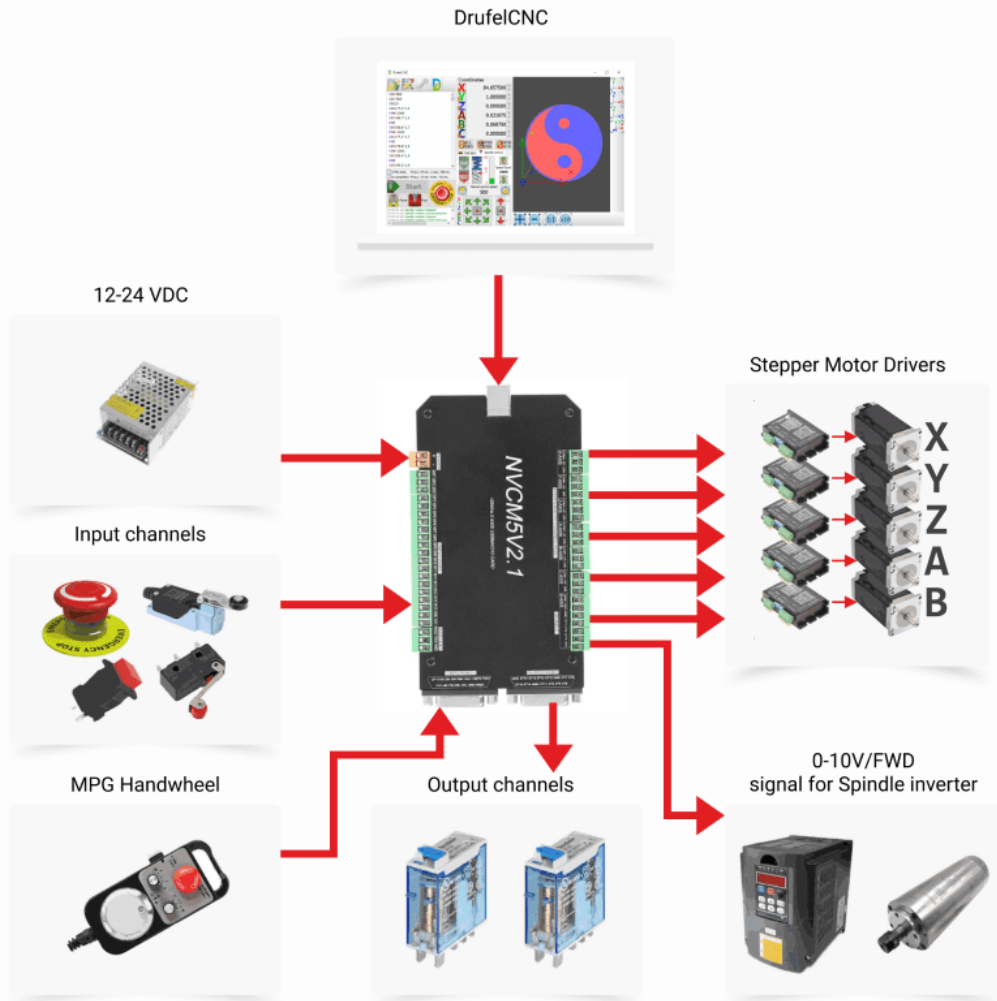

Using any CNC machine is a dangerous operation. Before use, all safety measures must be taken. If you do not have complete information, if you do not have an engineering background, then do not use this diagram. In case of improper connection, unexpected movement or any damage caused by the aforementioned consequences, there is no legal protection.

5. Connection diagram stepper motors and spindle

DrufelCNC

Connection diagram for NVCM5V2.1, stepper motors and spindle in DrufelCNC

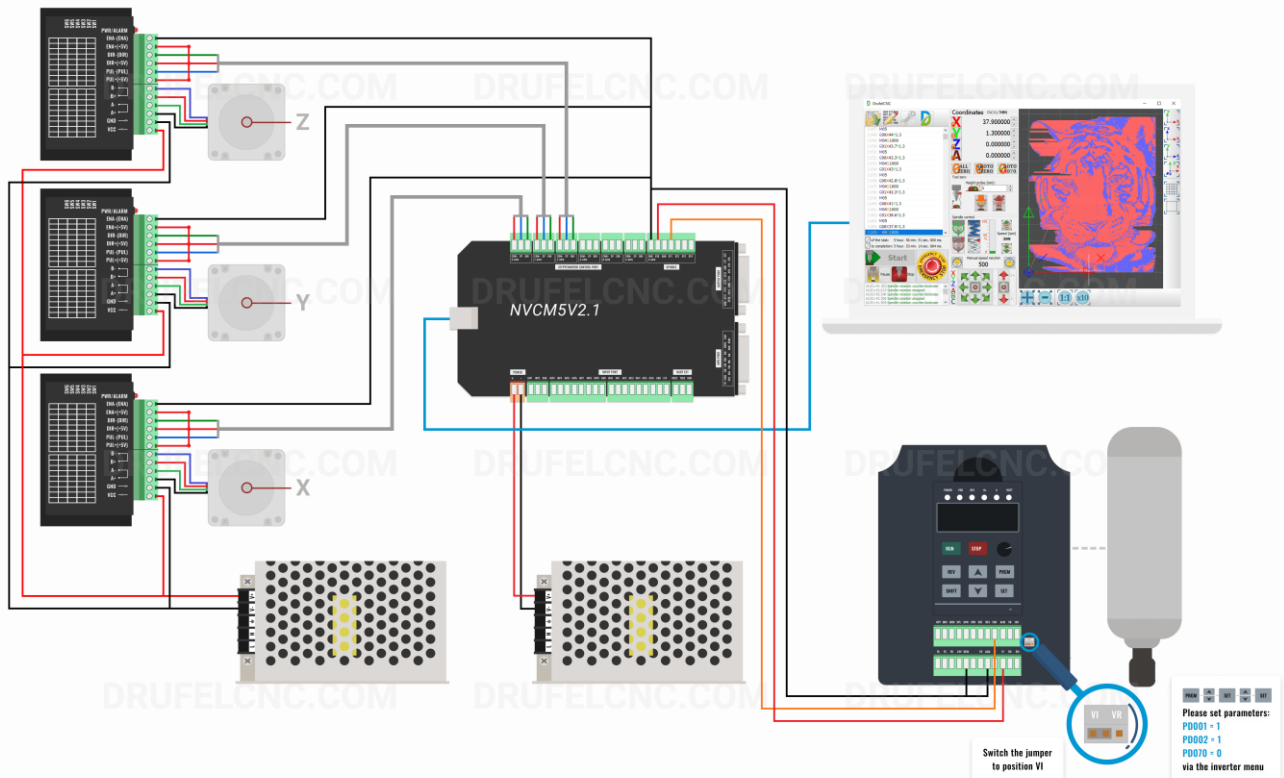

Using any CNC machine is a dangerous operation. Before use, all safety measures must be taken. If you do not have complete information, if you do not have an engineering background, then do not use this diagram. In case of improper connection, unexpected movement or any damage caused by the aforementioned consequences, there is no legal protection.

6. Connection diagram input ports

DrufelCNC

Connection diagram for NVCM5V2.1 and input ports DrufelCNC

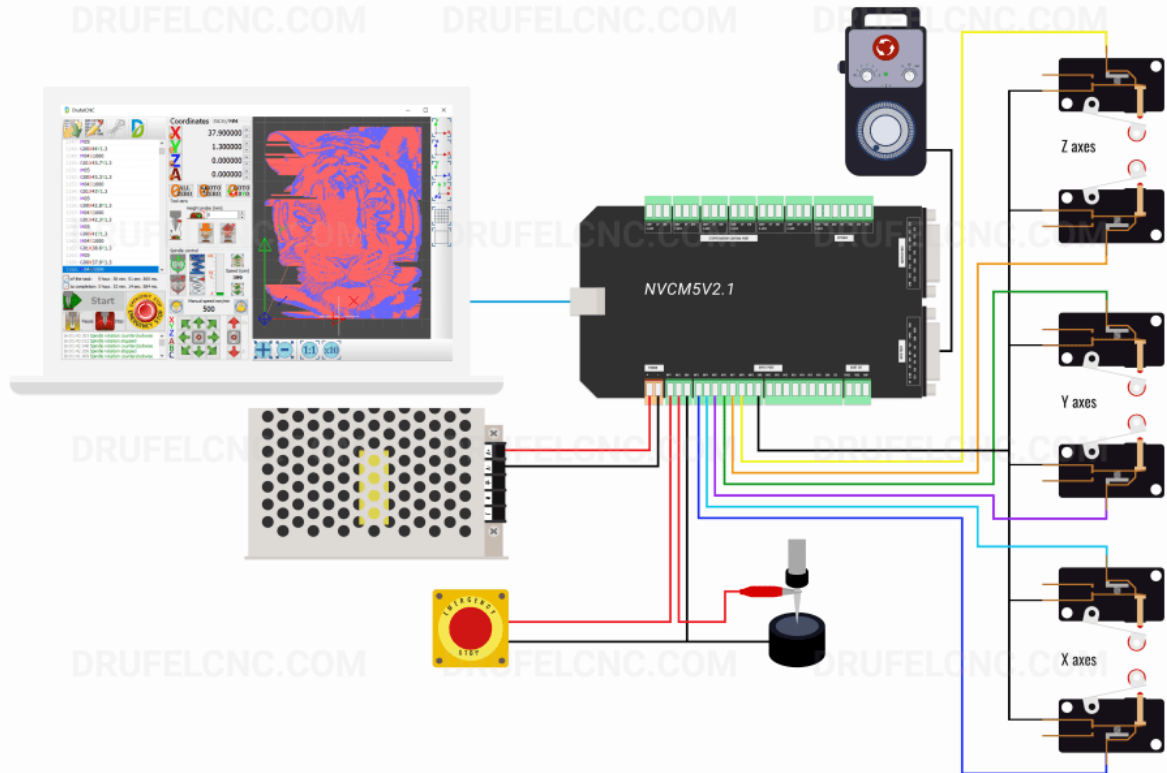

Using any CNC machine is a dangerous operation. Before use, all safety measures must be taken. If you do not have complete information, if you do not have an engineering background, then do not use this diagram. In case of improper connection, unexpected movement or any damage caused by the aforementioned consequences, there is no legal protection.

7. Connection diagram MPG



Connection diagram MPG to NVCM5V2.1

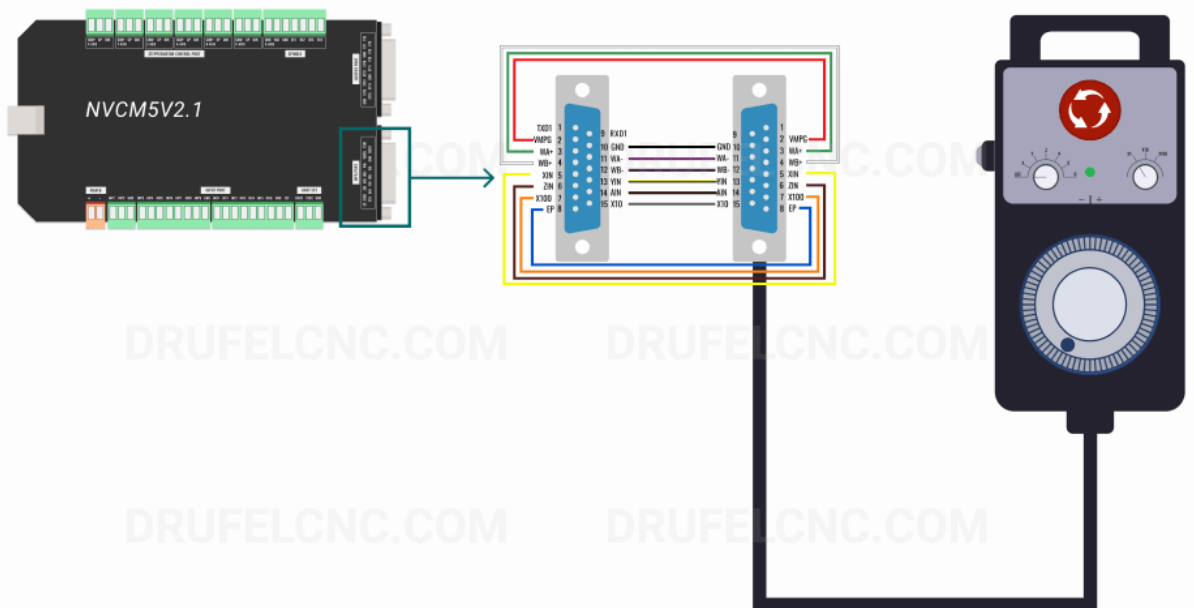

Using any CNC machine is a dangerous operation. Before use, all safety measures must be taken. If you do not have complete information, if you do not have an engineering background, then do not use this diagram. In case of improper connection, unexpected movement or any damage caused by the aforementioned consequences, there is no legal protection.

8. Installing DrufelCNC

To install the program you need to download the installation files on the official website www.drufelcnc.com. You can use one of the following files:

- DrufelCNC_installer_x64.exe, DrufelCNC_installer_x32.exe - this installation file will automatically install DrufelCNC on your computer documentation and examples of g-codes;
- DrufelCNC.zip - archive with DrufelCNC x32 and x64 with examples and documentation.

Run the desired file and follow the installation instructions.

Description of the installation process

1. *Start the installation process.* In this installation window you need to select the program installation mode.

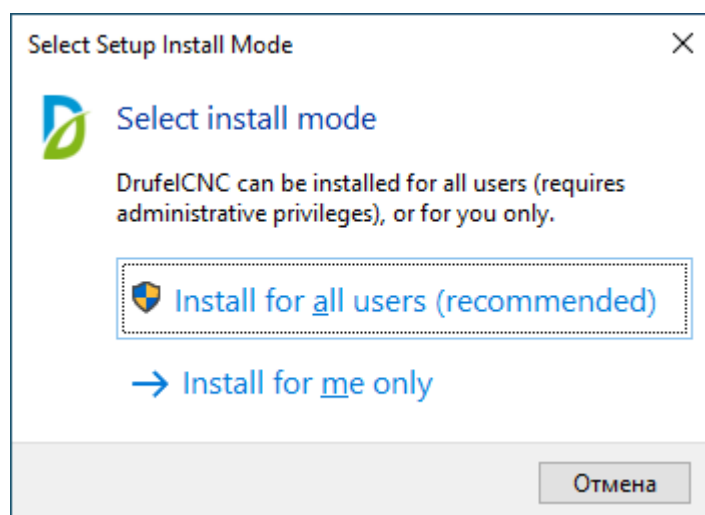

2. License Agreement. The License Agreement installation window contains the text of the license agreement for the use of the DrufelCNC software product. Please read the agreement and select "I accept the terms of the license agreement". To continue the installation, click "Next." During the entire installation process, to return to the previous installation step, click the Back button. To exit the installer, click Cancel.

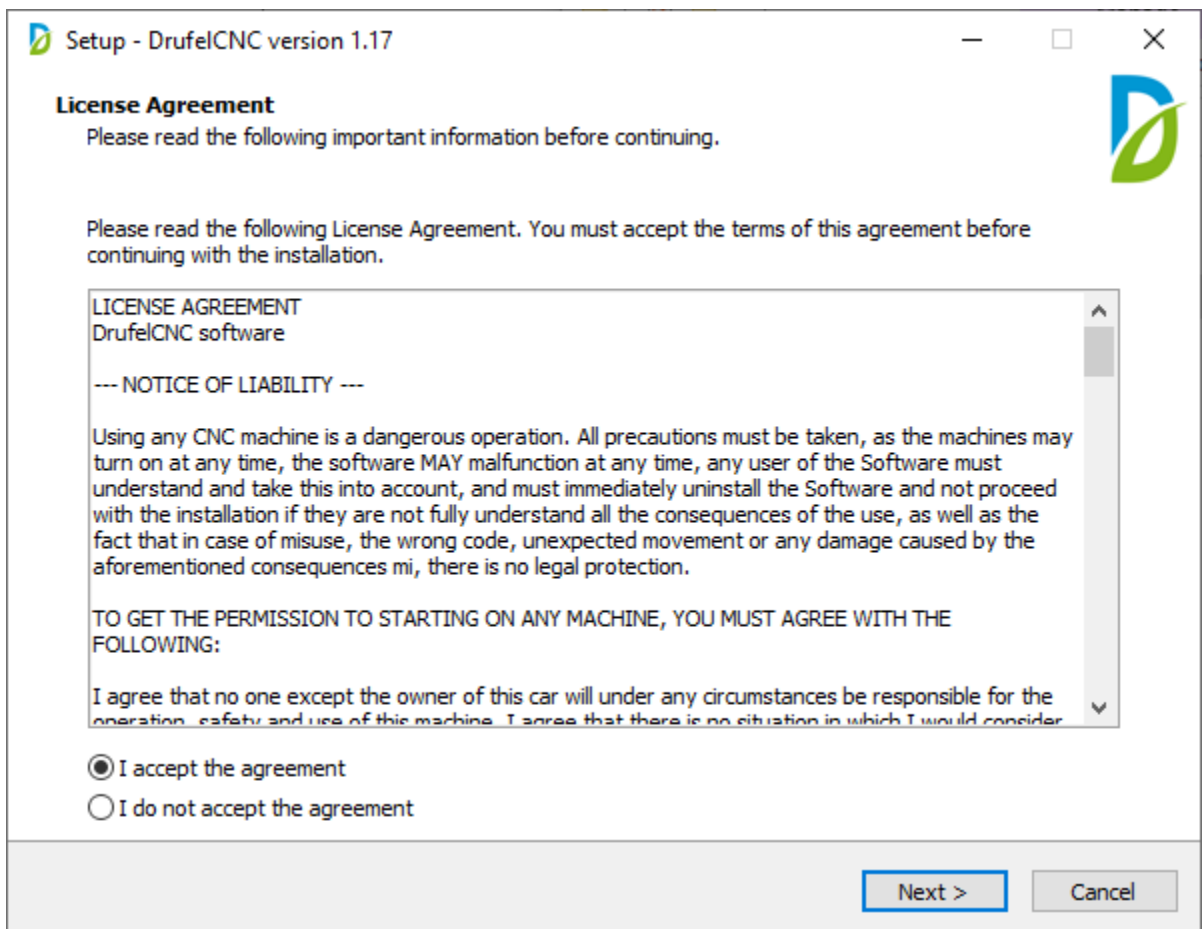

3. Select the directory in which the installation will be made. At this stage of the installation, you must specify the directory in which DrufelCNC will be installed. The default installation directory is "C:\Program Files\DrufelCNC". If you wish, you can specify any other path. Depending on the version of Windows, the default path may be different. To continue the installation, click "Next."

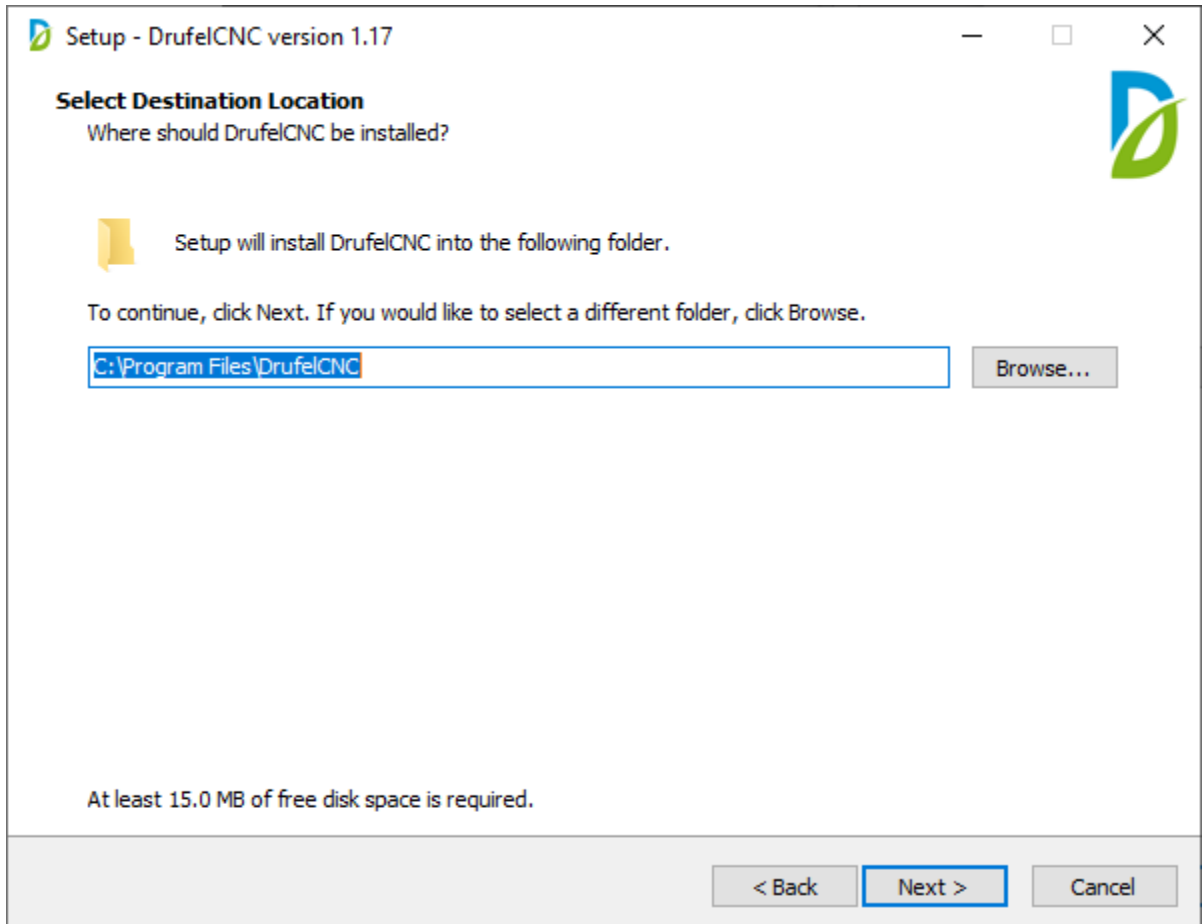

4. *Selection of additional installation parameters.* At this stage of installation, it is necessary to determine the need to create program shortcuts on the desktop. By default, a program shortcut will be created. To continue the installation, click "Next."

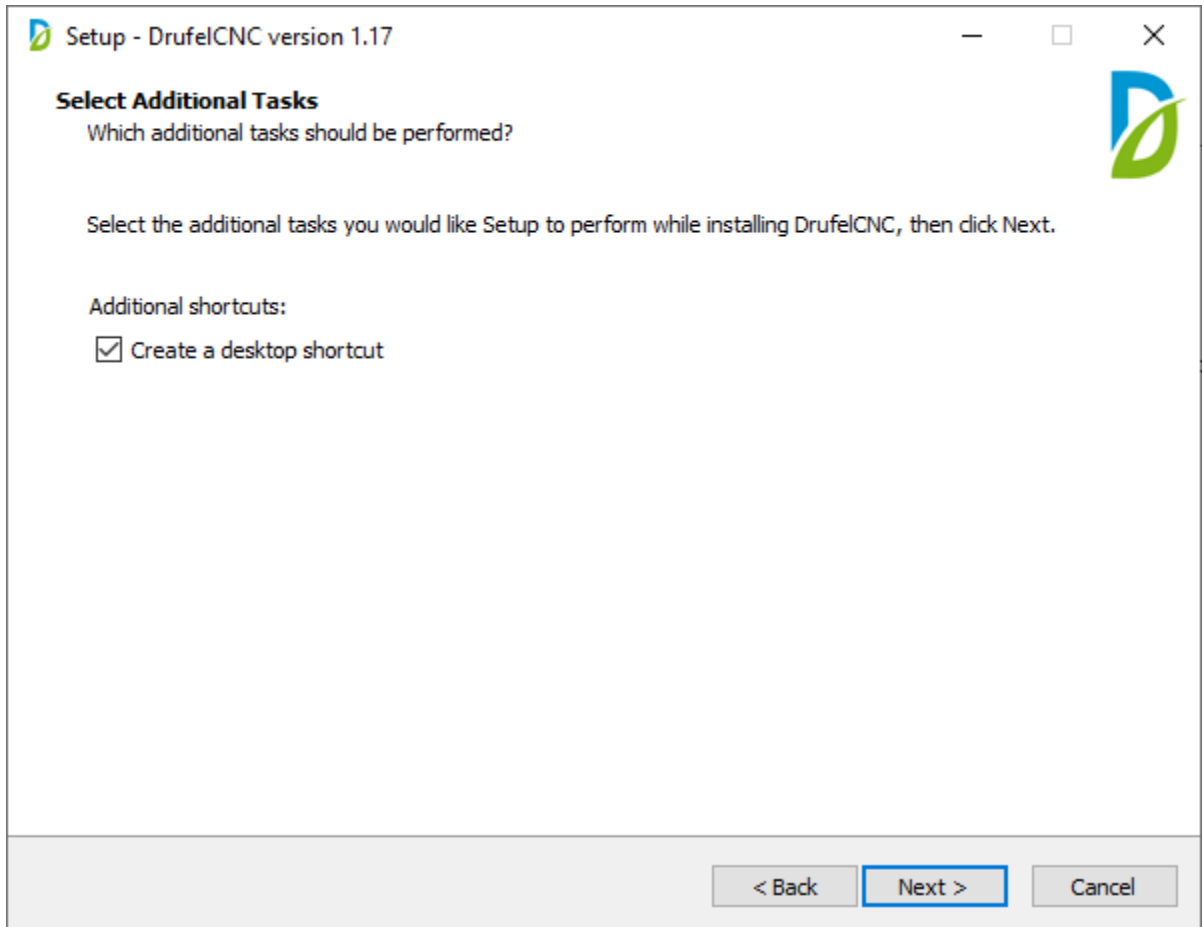

5. *Preparing for installation.* A window with information about the selected installation type, selected components and installation directory will be displayed. Check the information and click "Install."

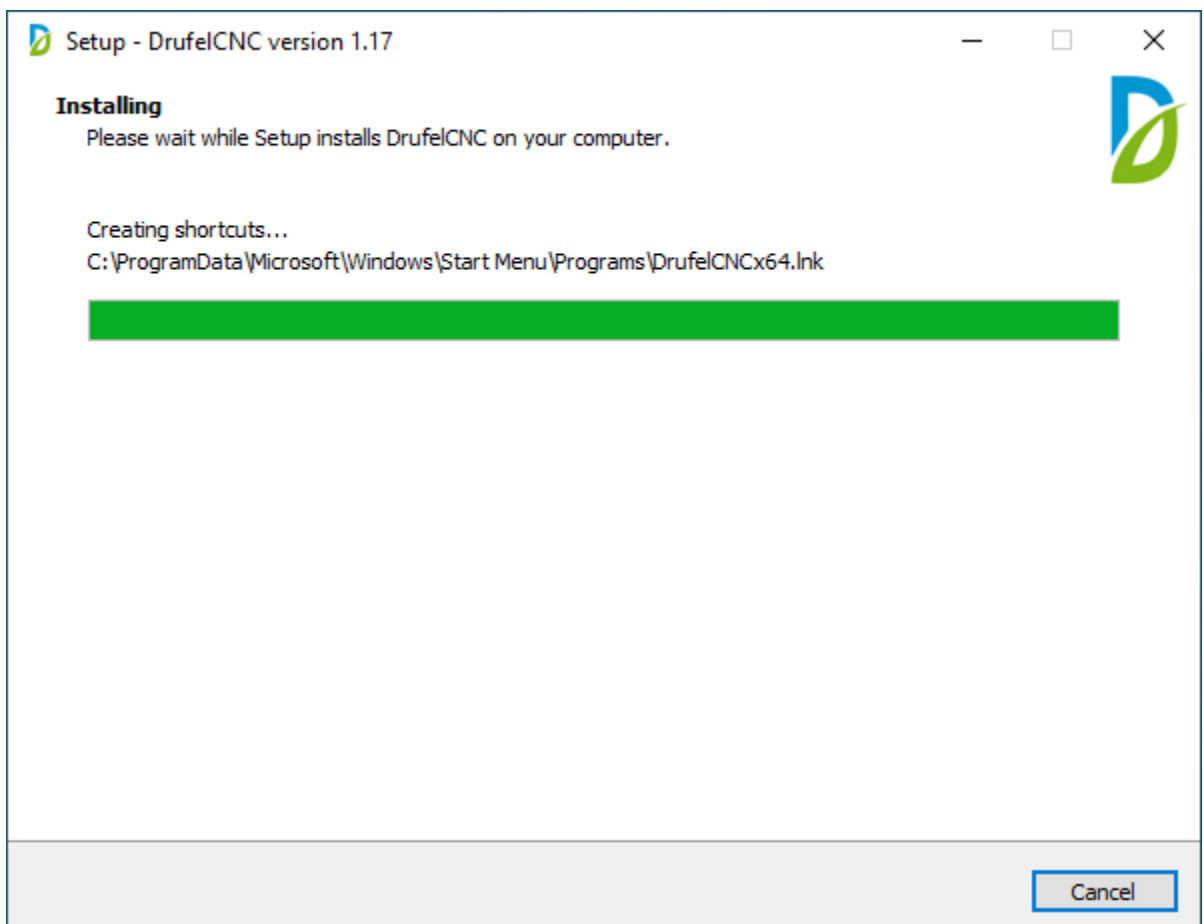
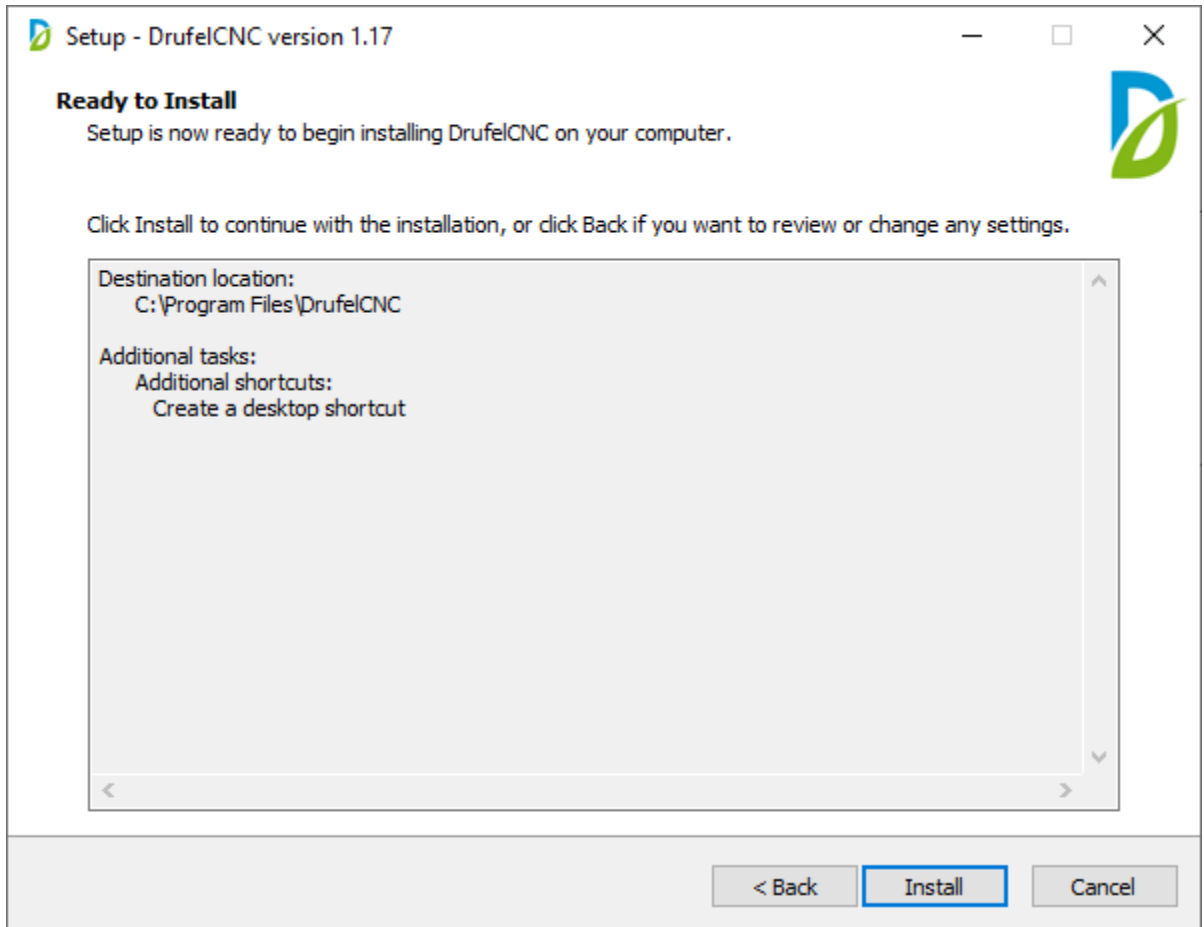

6. *The final stage of installation.* At the last stage, the installation program will report the result and will offer to start the programs depending on the type of installation selected earlier. By default, you can run the program. To complete the installation, click Finish.

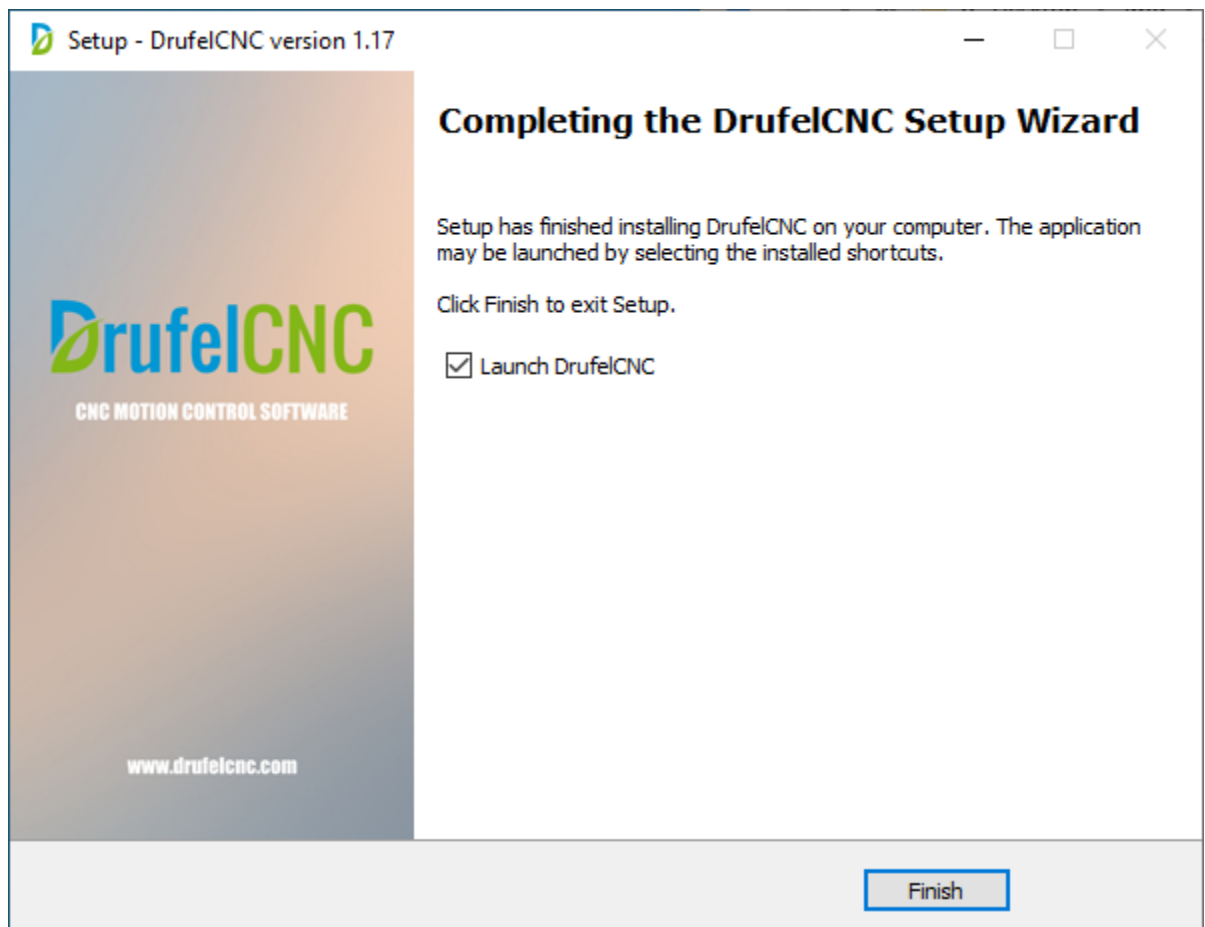

9. DrufelCNC interface

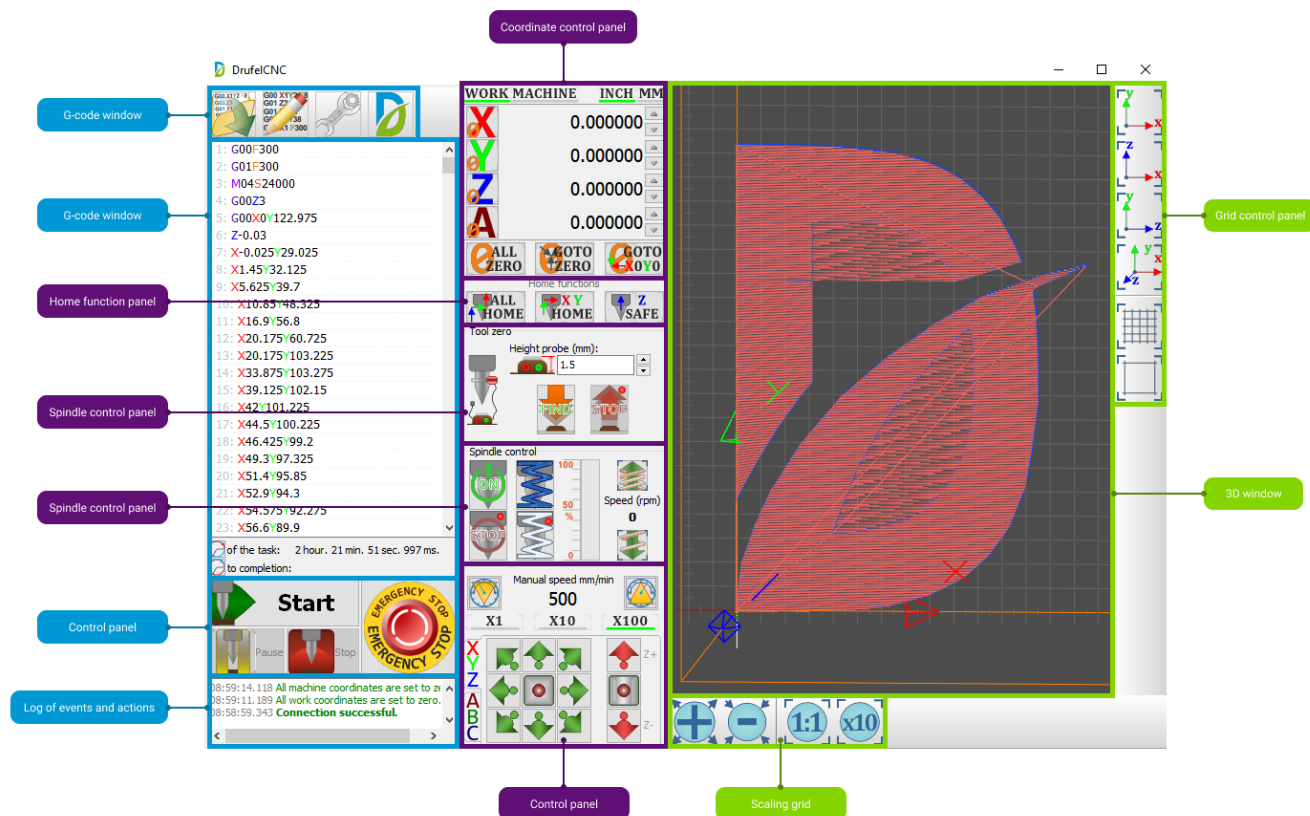

The DrufelCNC interface can be divided into three blocks:

1. G-code window
2. Base functions
3. 3D window

G-code-window:

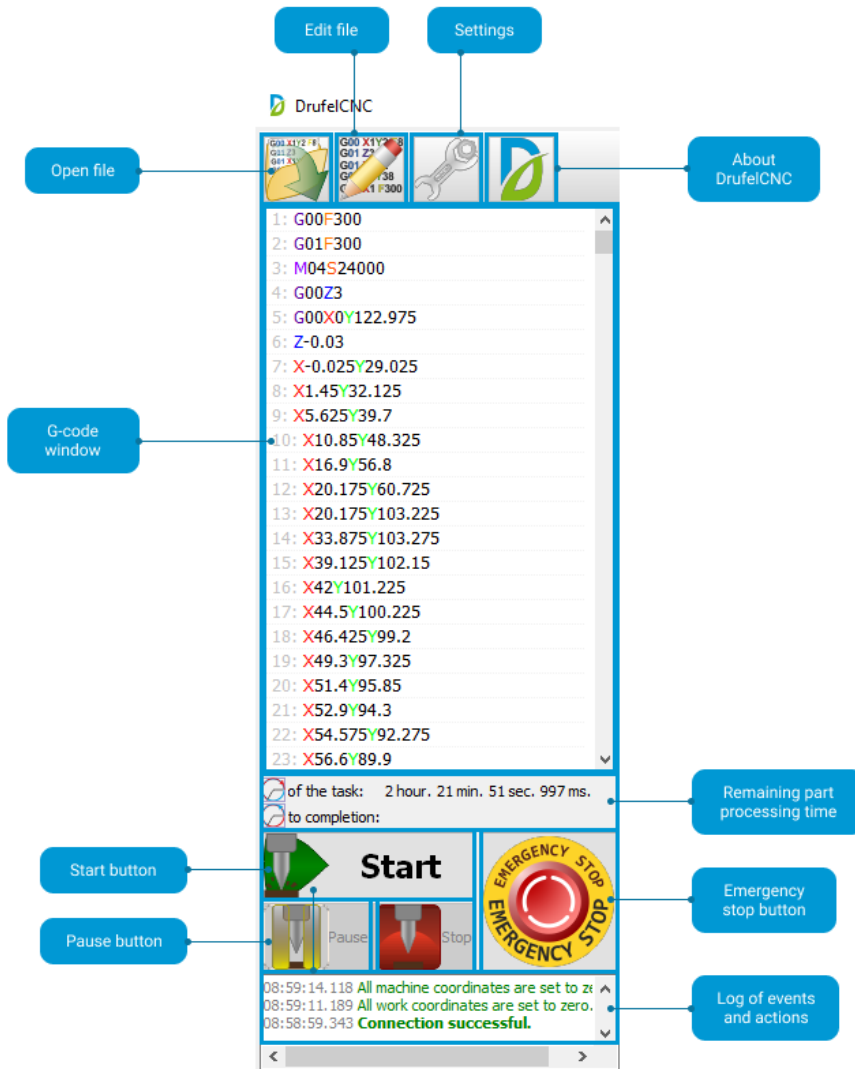

Functions	Description
Open file	Open file button
Edit file	Edit g-code file button
Settings	Function setting button
About DrufelCNC	DrufelCNC information button
G-code window	Display of G-code
Start	Start button
Pause	Pause button
Remaining time part	Remaining part processing time
Emergency stop	Emergency stop button
Log of events and actions	Log of events and actions

Base functions:

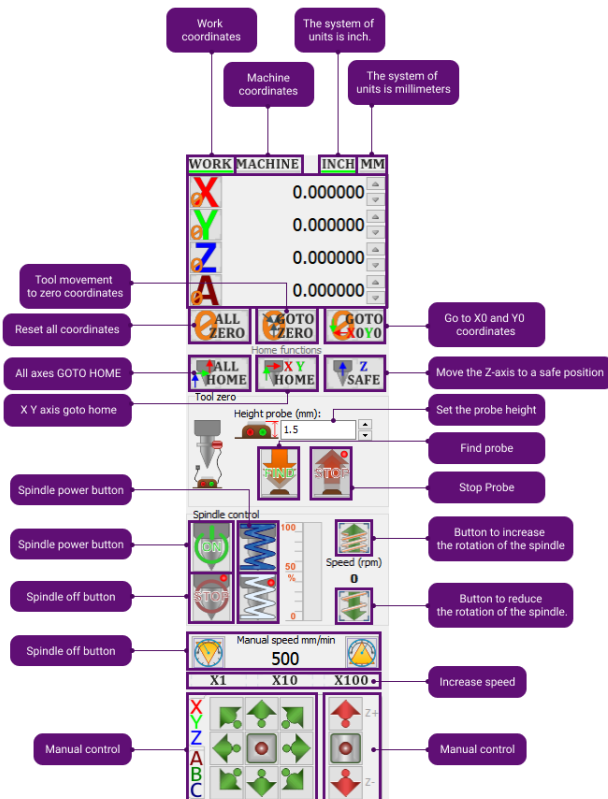

Functions	Description
Work coordinates	Activating work coordinate mode
Machine coordinates	Activating machine coordinate mode
Inch	Activating inch mode
Millimeters	Activating millimeter mode
All zero	Reset all coordinates
Go to home	Tool movement to zero coordinates
Go to X0 Y0	Go to X0 and Y0 coordinates
All home	All axes GOTO HOME
X Y home	X Y axis goto home
Z safe	Move the Z-axis to a safe position
Set the probe height	Set the probe height
Find probe	Find probe
Stop Probe	Stop Probe
Button to increase the rotation of the spindle	Button to increase the rotation of the spindle
Button to reduce the rotation of the spindle.	Button to reduce the rotation of the spindle.
Spindle power	Spindle power button
Spindle off	Spindle off button
Turn on cooling	Turn on cooling button
Turn off cooling	Turn off cooling button
Panel manual speed	Panel manual speed
Manual control axes	Manual control axes
Manual control z axes	Manual control z axes
Increase speed	Increase speed
Decrease in spindle rotation	Button to reduce the rotation of the spindle
Increase spindle rotation	Button to increase the rotation of the spindle
Stop Probe	Stop Probe button
Find probe	Find probe button
Set the probe height	Probe height button

3D window:

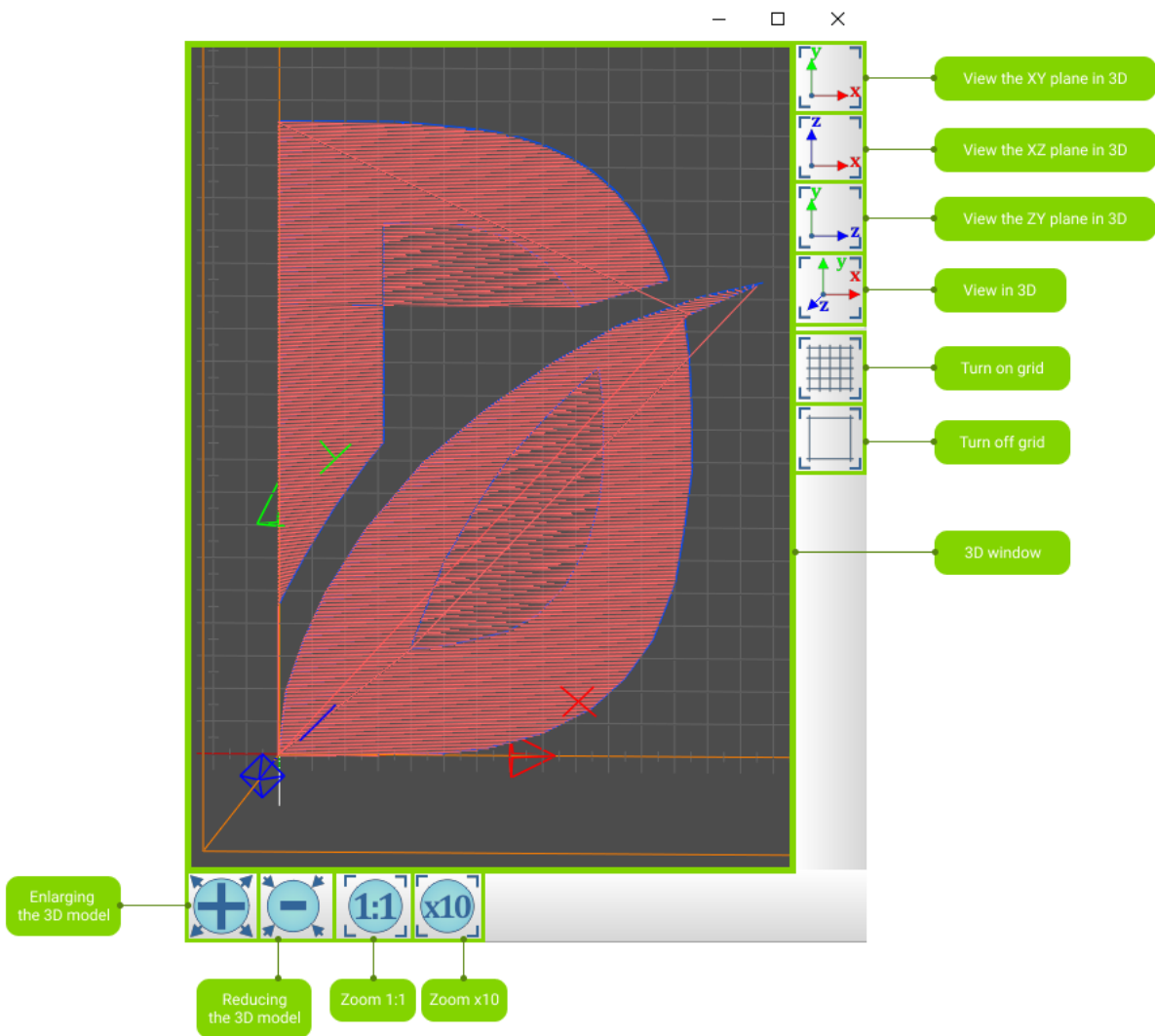

Functions	Description
Scale 3D model	Scale 3D model button
Reducing the 3D model	Reducing the 3D model button
Zoom 1:1	Zoom 1:1 button
Zoom x10	Zoom x10 button
3D window	Display of 3D-model
Turn off grid	Turn off grid button
Turn on grid	Turn on grid button
View in 3D	View in 3D button
ZY plane in 3D	View the ZY plane in 3D
XZ plane in 3D	View the XZ plane in 3D
XY plane in 3D	View the XY plane in 3D

10. Run the program

To run the program, use the version depending on the bitness of your operating system:

- DrufelCNCx32.exe - version for 32-bit operating systems
- DrufelCNCx64.exe - version for 64-bit operating systems

The main window of the program.

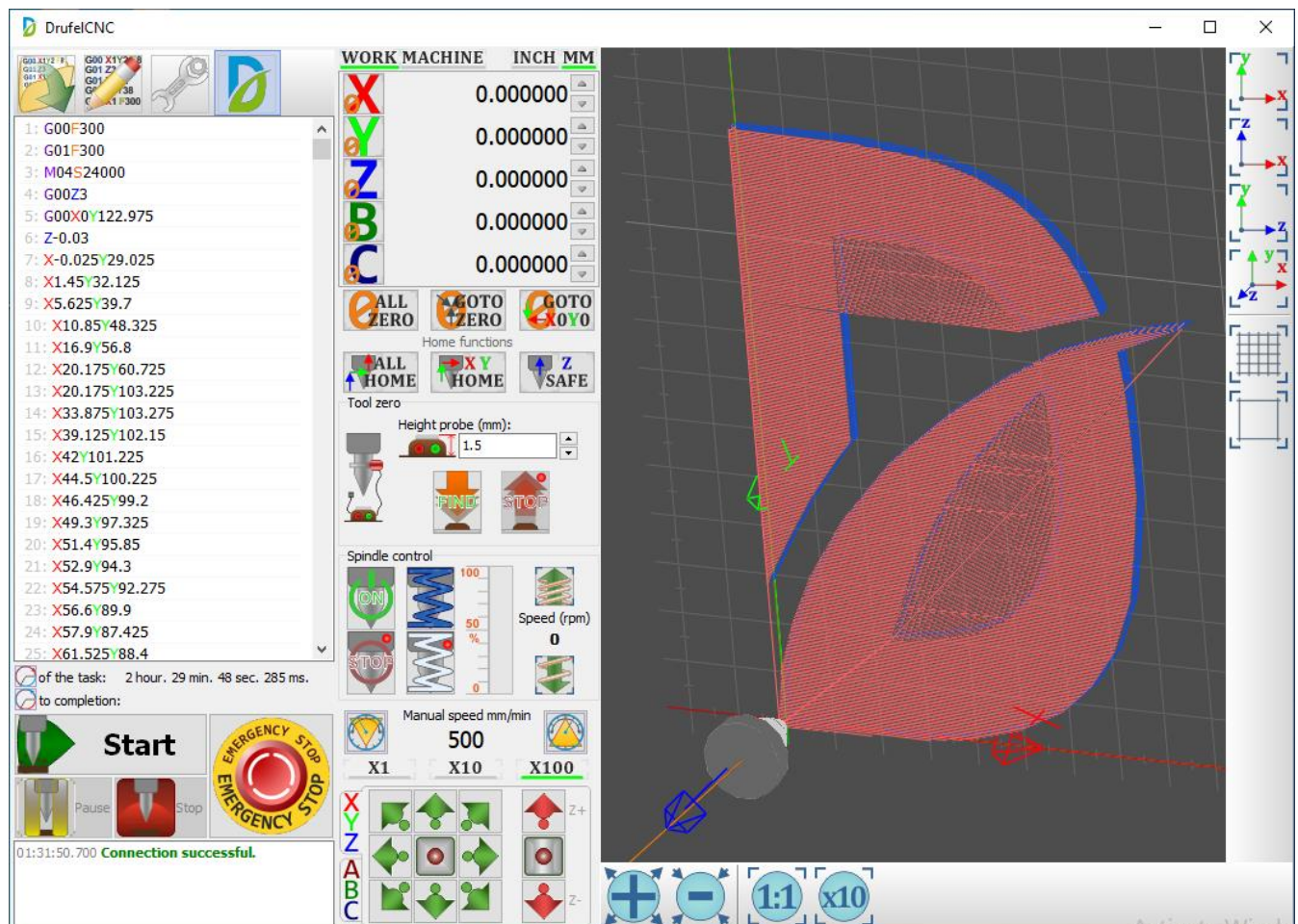

In the lower left corner displays the status of the connection to the USB controller, and other informational messages.

11. Customization

To configure DrufelCNC you must click on the button with the image of the key





. Next, go to the section of settings that interests you.

11.1.Common

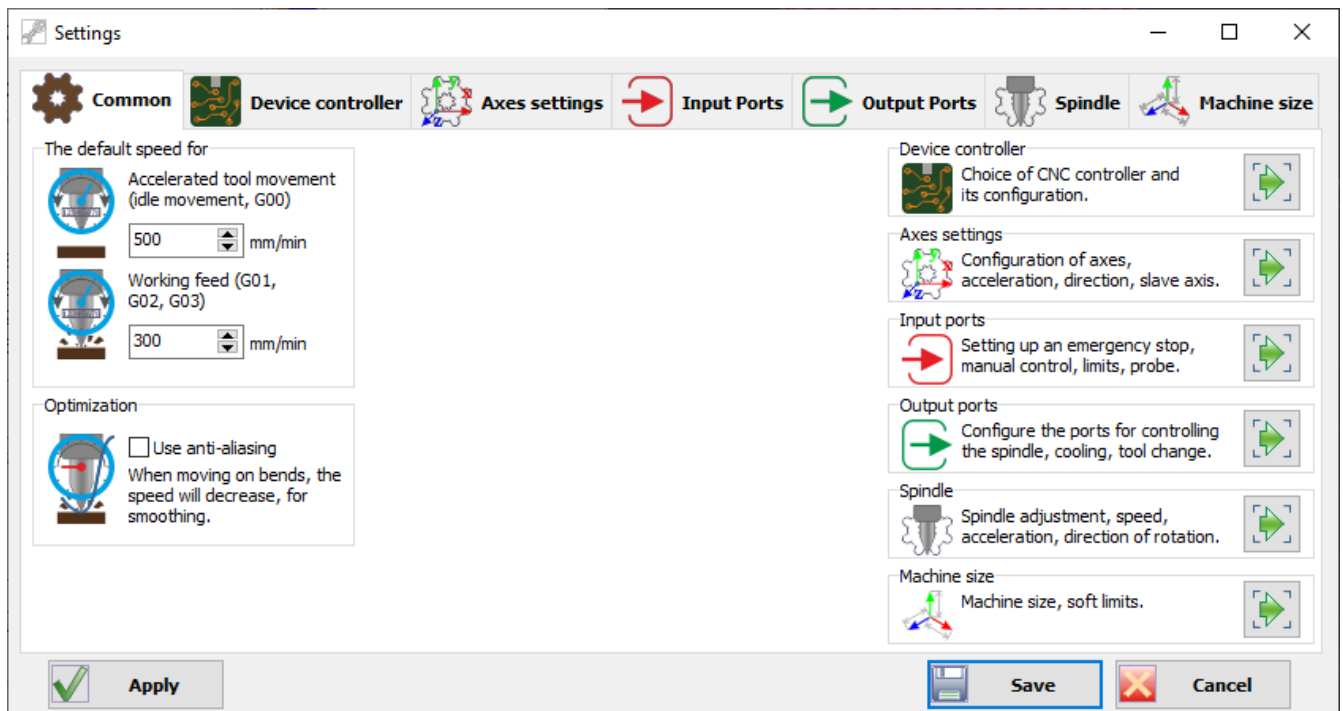
In the common tab, you can set values for accelerated tooth movement (idle movement, G00), working feed (G01, G02, G03) and use anti-aliasing.



 Accelerated tool movement (idle movement, G00) 500 mm/min	Default speed for G00 commands. If no speed for G00 is specified in the G code file, then G00 commands will use that speed.
 Working feed (G01, G02, G03) 300 mm/min	Default speed for G01, G02, G03 commands.



Use anti-aliasing
When moving on bends, the speed will decrease, for smoothing.

When moving along curved vectors, the speed of movement will decrease.

11.2. Controller Configuration

In the window that opens, go to the «Device Controller» tab.

Settings

Common Device controller Axes settings Input Ports Output Ports Spindle Machine size

Devices: Automatic selection of supported device Refresh

Name	Manufacturer	VID	PID	Version	Serial number	Outp...	Input...
<input checked="" type="radio"/> NVxMxV2	NOVUSUN	49745	0	256	0001A0000000	65	65
		33006	33	256		0	9

Period sending commands: 5 ms

The duration of the control pulse: 5 us

Device mode: Standard MPG

The period of scanning coordinates: 20

Apply Save Cancel

In the hardware section, you must select a controller by setting a point in the radio button block opposite the USB controller. Save the settings.

11.3. Axis Setup

To configure a stepper motor or servo drive, go to the Axis Settings tab.

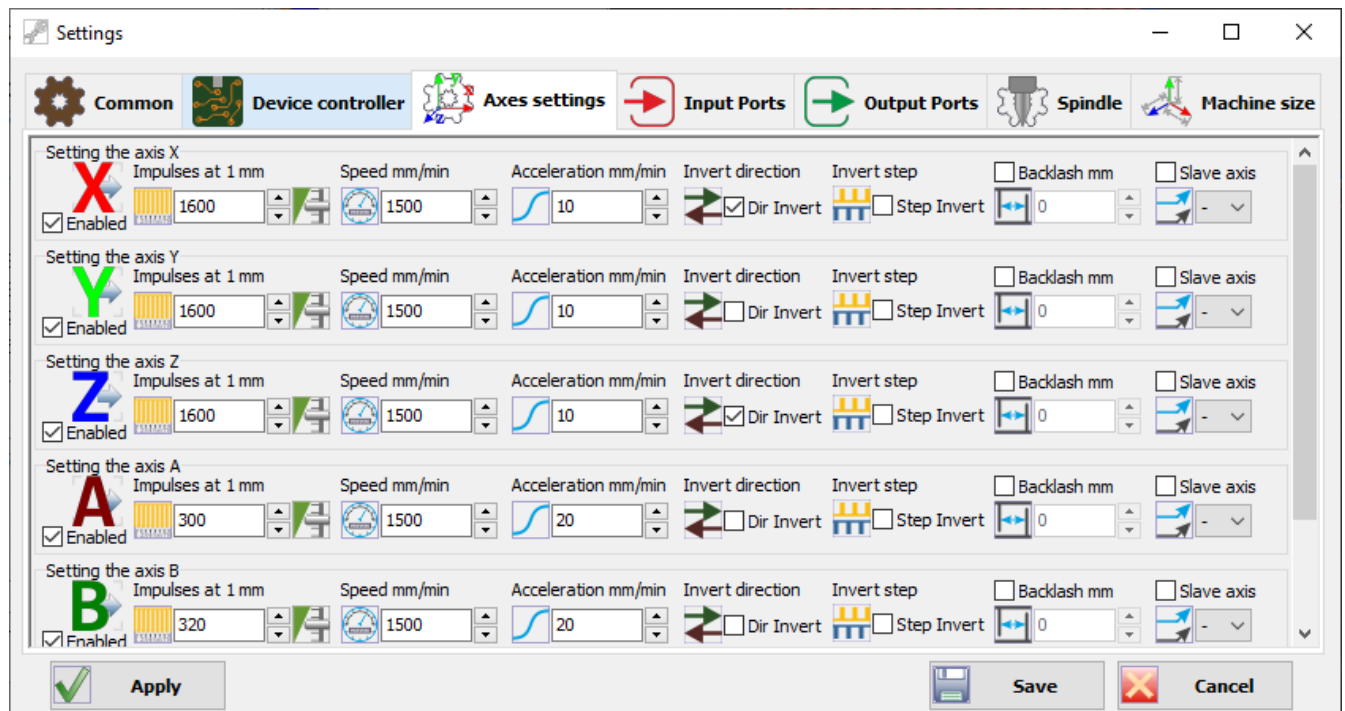

Set the required number of pulses for each axis. Save the settings. If necessary, specify the submission of the axes. Use the inversion setting to change the direction of rotation of the motor.

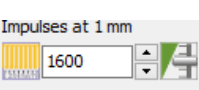
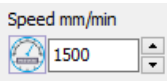
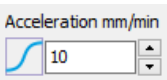
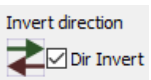
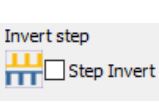
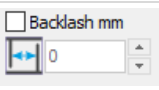
	Enables the axis to be displayed in the coordinate list.
	The number of pulses per millimeter. You can use the calibration function to calculate.
	Maximum speed of the axis movement.
	Smooth acceleration of the axis movement.
	Invert the direction of movement of the axis.
	Invert the step signal when transmitting the axis movement commands.
	Backlash of the ball screw.



A slave axis can be defined for an axis. Then, the slave axis will move along with the current.

11.3.1. Calibrate axis

By clicking on the calibration button  for a specific axis, the axis calibration window will open. This window is for calculating the number of pulses per mm.

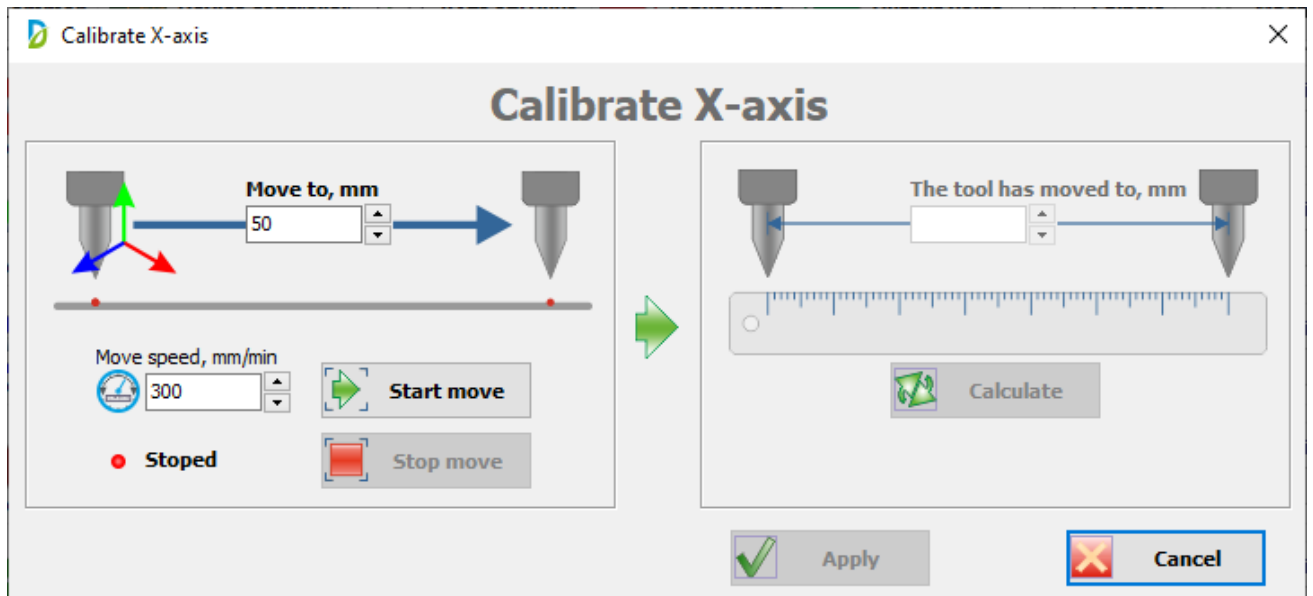

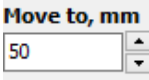
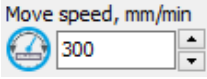
In the "Move to" field , enter a value for the distance by which you want to move the tool. In the "Move speed" field , set the speed of movement.

Attention! This speed must be slow! This is necessary so that you can quickly respond to an emergency and not damage the machine.

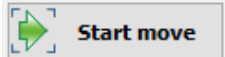
After that click on the «Start move»  button. After pressing the button, movement will begin for the specified segment.

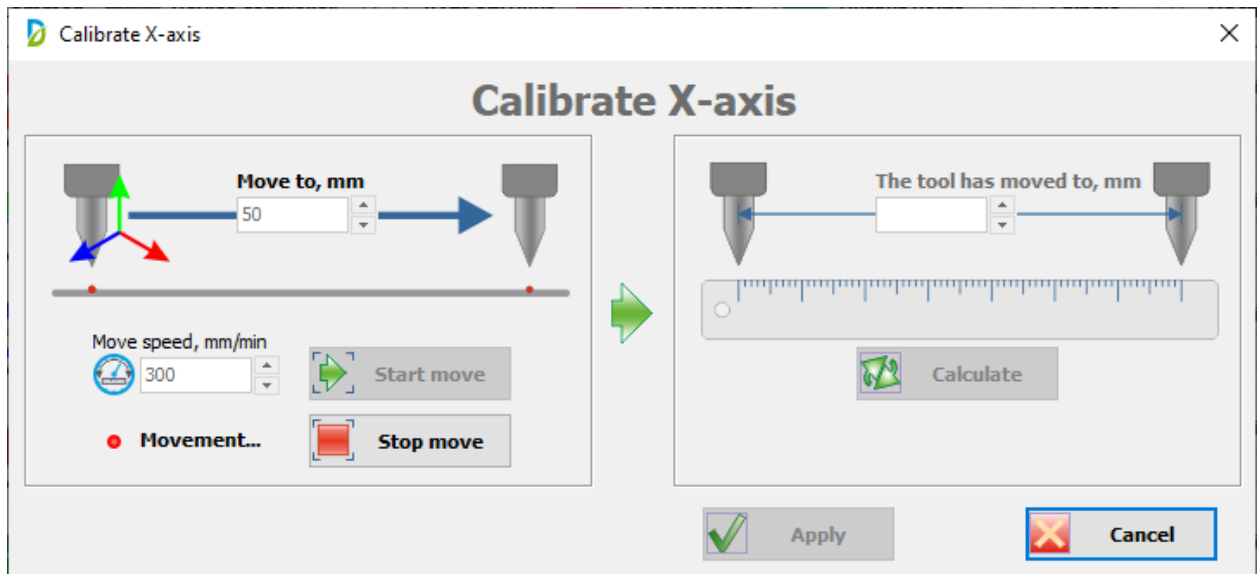

After the tool has finished moving, use the ruler to measure the actual distance the tool moved.

Enter this value in the «The tool has moved» to field.

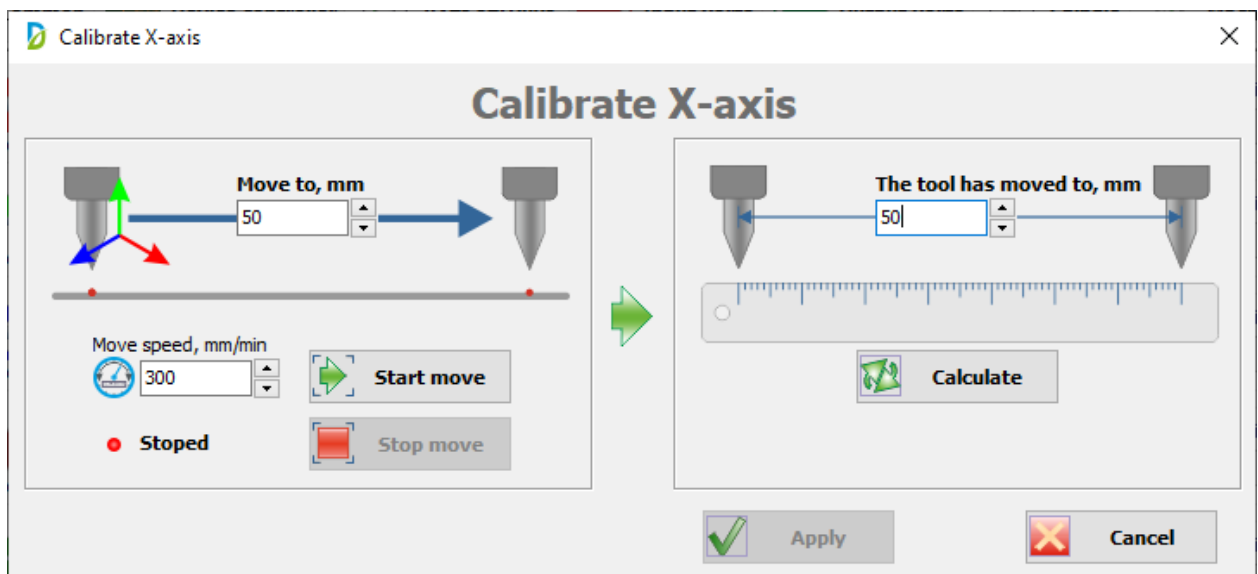

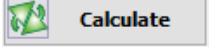
Click the «Calculate»  button. After pressing, the number of pulses per 1 mm will be calculated that you need to set for the axis to be calibrated.

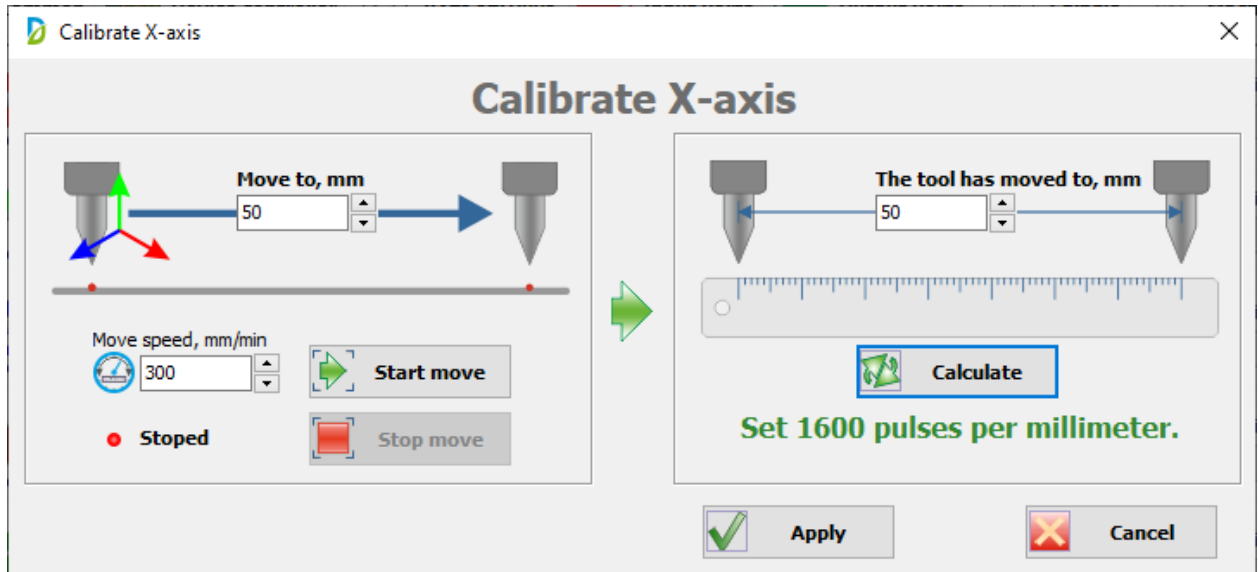

Click the «Apply»  button to apply the calculation results.

11.4. Configure Input Ports

To configure input ports, go to the Input Ports tab.

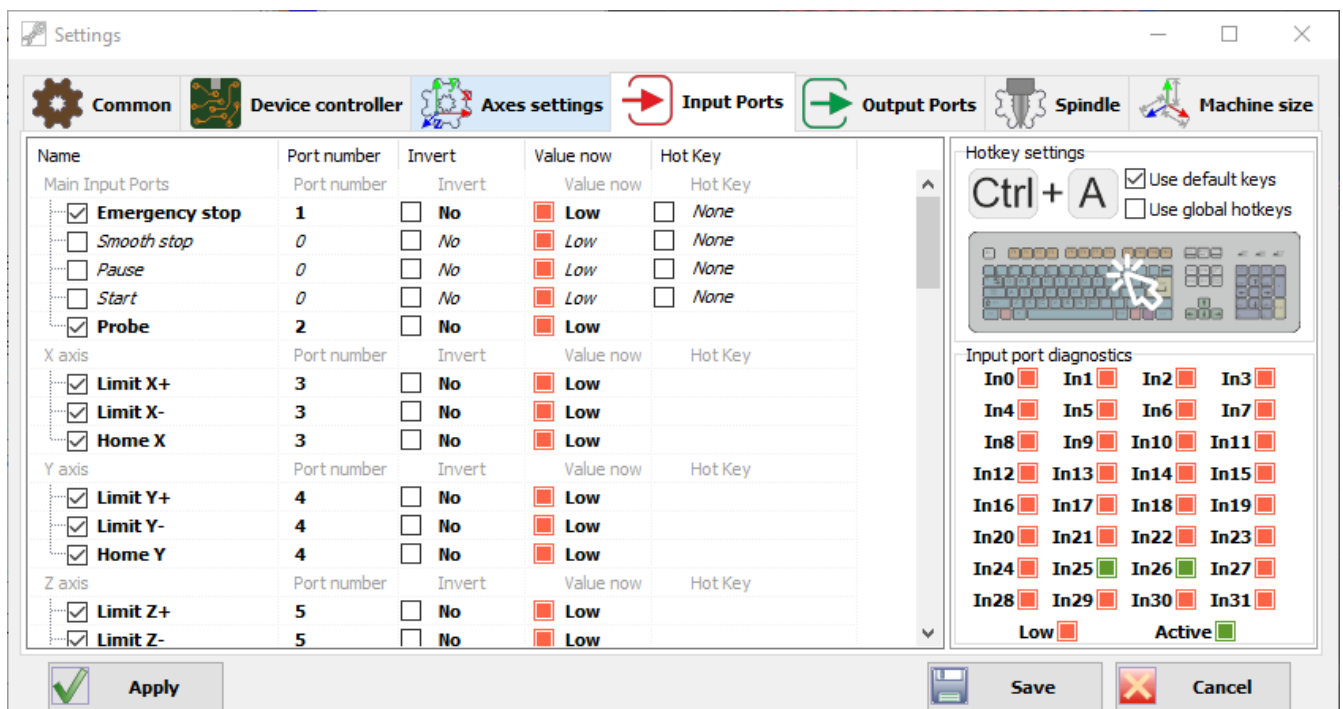

Set the input port numbers according to the configuration of the machine and the CNC controller. Save the settings.

11.4.1. Input port diagnostics

DrufelCNC - software for controlling CNC machines. Read more: <https://drufelcnc.com>

This panel displays the current state of the controller input ports.

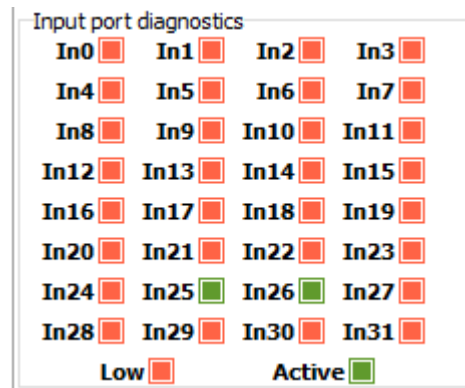

A red LED indicates ■ there is no signal on the input port.
A green LED indicates ■ signal is present on the input port.

11.4.2. Hot keys

In order to set your hot keys, you need to click on the Hot Key column of a specific input port.

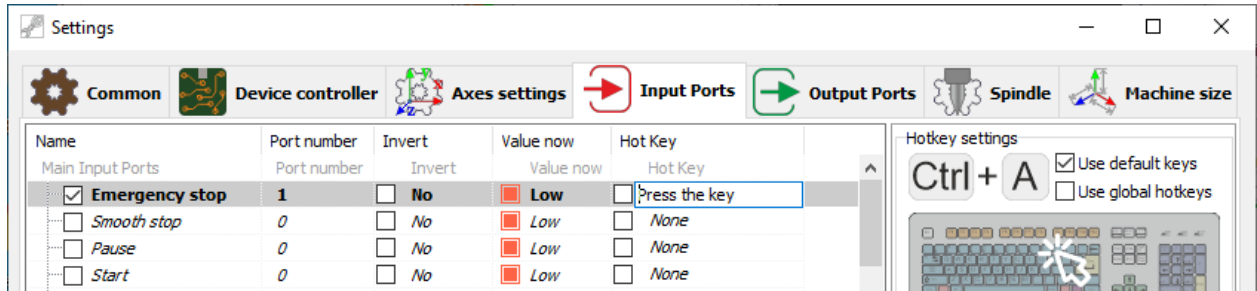

Next in this field you must specify your keyboard shortcut that you want to use.

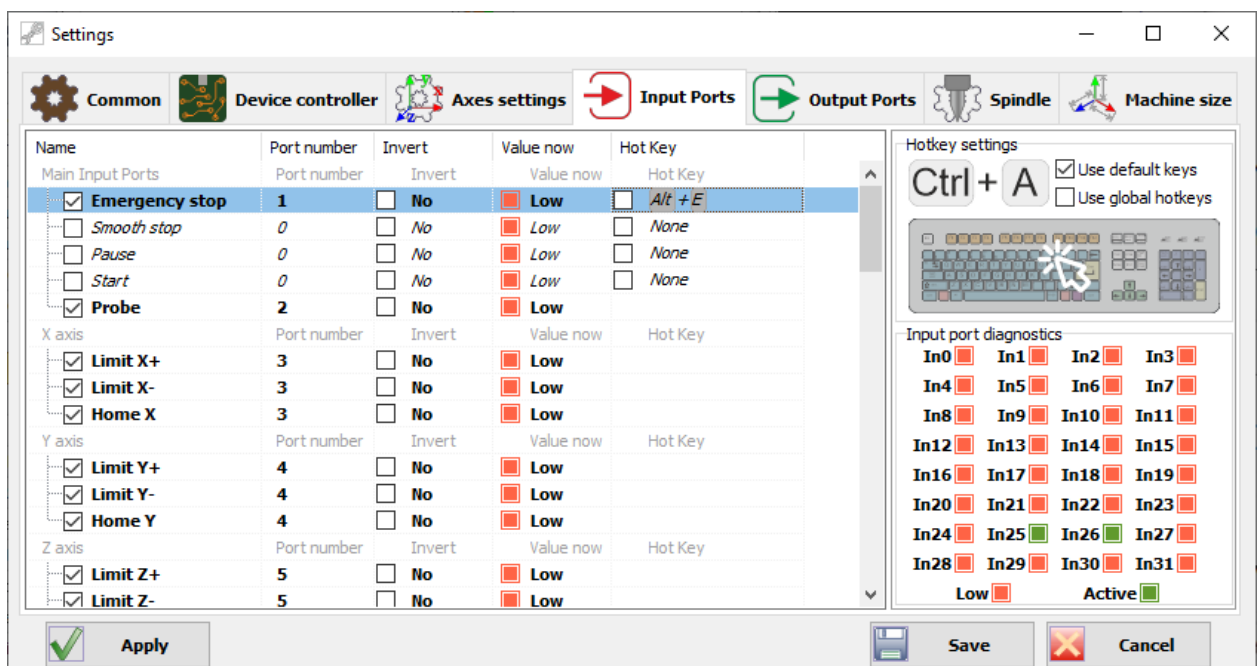

«Use global hotkeys» - this function in which if the DrufelCNC window is not active, then hotkeys will still go to DrufelCNC.

«Use default hotkeys» - this function for hotkeys will work according to the following list:

Default Hotkey Info

Default hotkeys

Emergency stop	Start	F5 Spindle On/Off
Smooth stop	Jog X++	Spindle Speed +10%
Jog X--	Jog Z++	Spindle Speed -10%
Jog Y++	Jog Z--	Jog Speed +100
Jog Y--	Jog A++	Jog Speed -100
	Jog A--	

Attention! Custom shortcuts take precedence over the default keys.

11.5. Configuring output ports

To configure output ports, click the Output Ports tab.

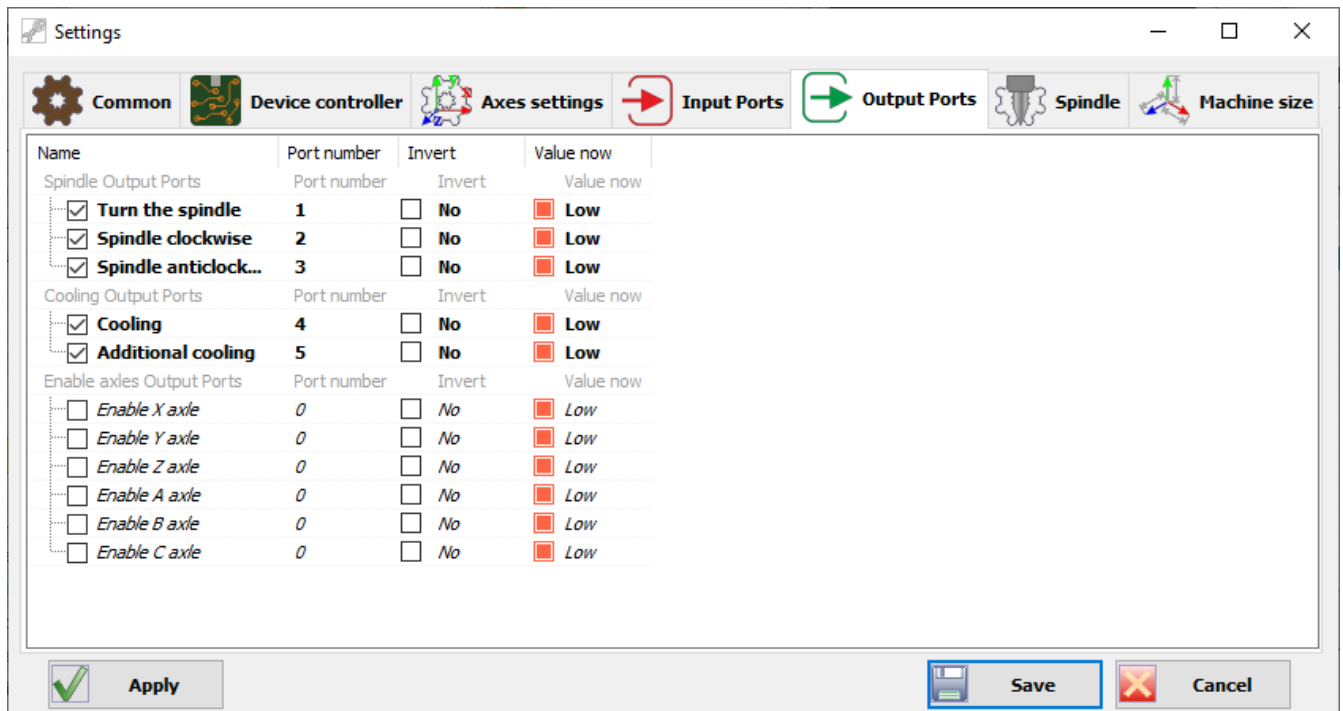

Set the output port numbers according to the configuration of the machine and the CNC controller. Save the settings.

11.6. Spindle adjustment

To configure the spindle parameters, you need to go to the "Spindle" tab.

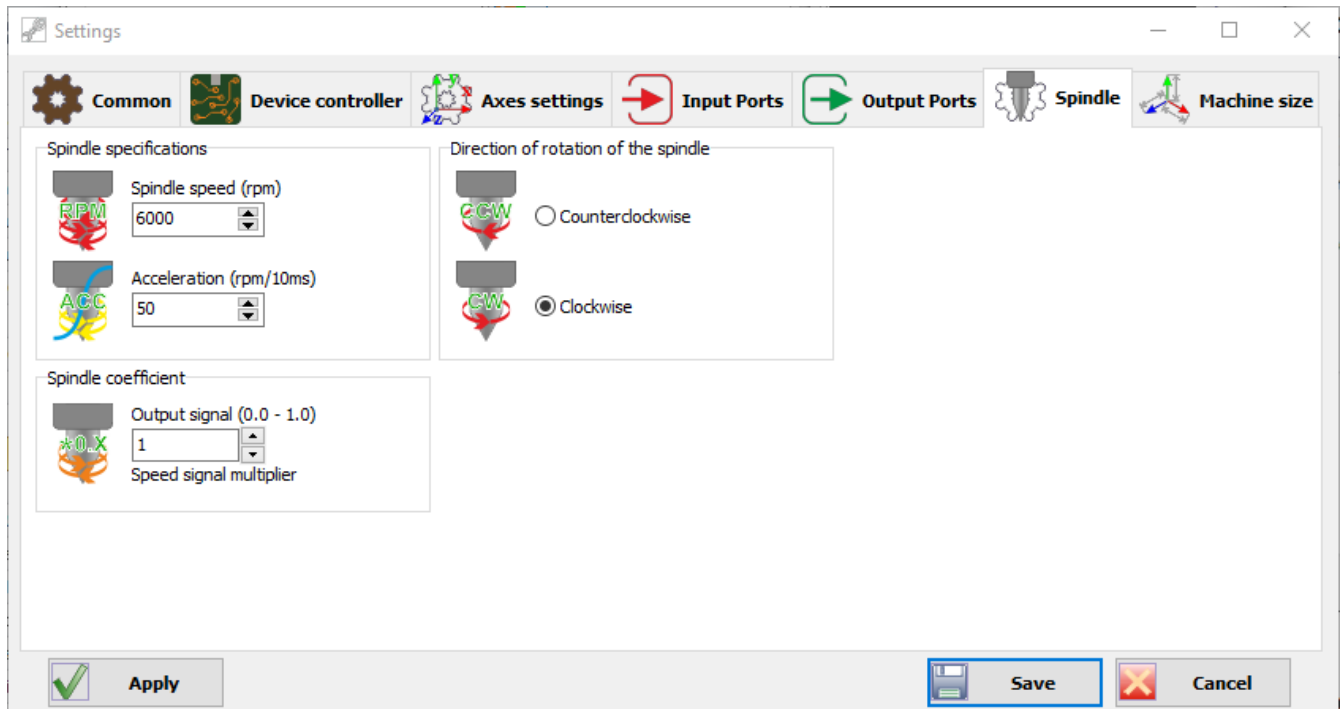

Set the speed and acceleration parameters according to the spindle specification. Set the default spindle rotation direction.

Set the spindle coefficient. Save the settings.

Spindle speed  Spindle speed (rpm) 6000 - the nominal number of revolutions per minute for your spindle.

Acceleration  Acceleration (rpm/10ms) 50 - when the spindle is turned on, the spindle rotation speed will be smoothly set in accordance with the specified acceleration.

Spindle coefficient  Spindle coefficient Output signal (0.0 - 1.0) 1 Speed signal multiplier - if you need to calibrate the output value of the port 0-10V then change this multiplication factor.

With this **Counterclockwise/Clockwise** setting,

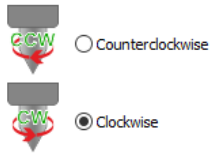

you can set the direction of rotation of the spindle when you press the «Turn the spindle»  button in the main window.

11.7. Machine size

With these settings you can customize the machine dimensions, soft limits, home function.

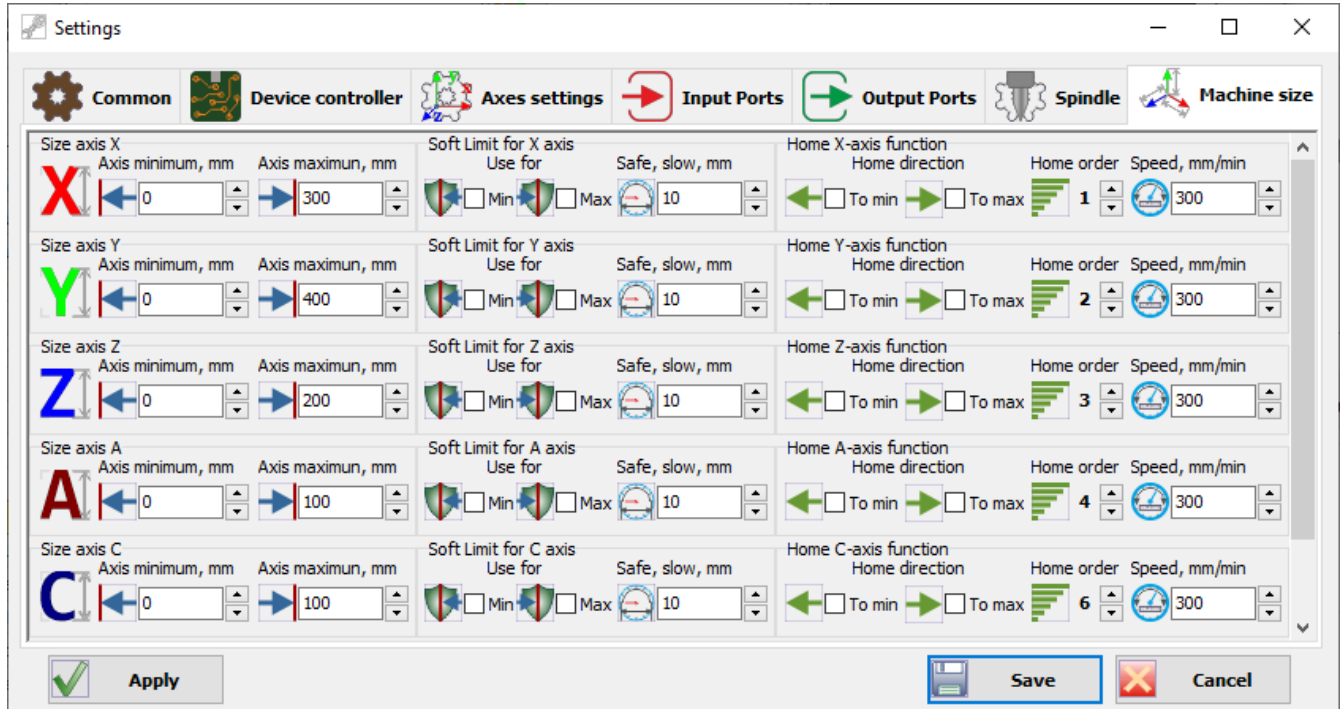

11.7.1. Size axis

Set the min / max limits for your machine.

Attention! The limits are specified in machine coordinates. The difference between the min and max should be the actual axis length of your machine.

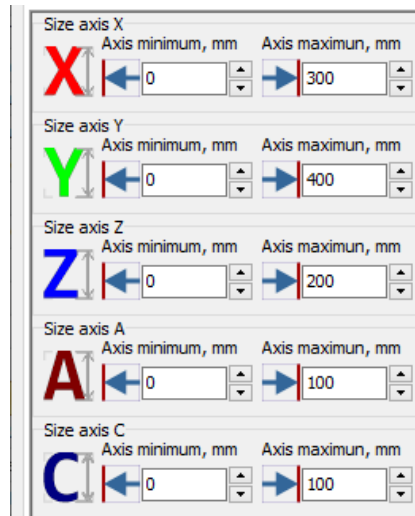

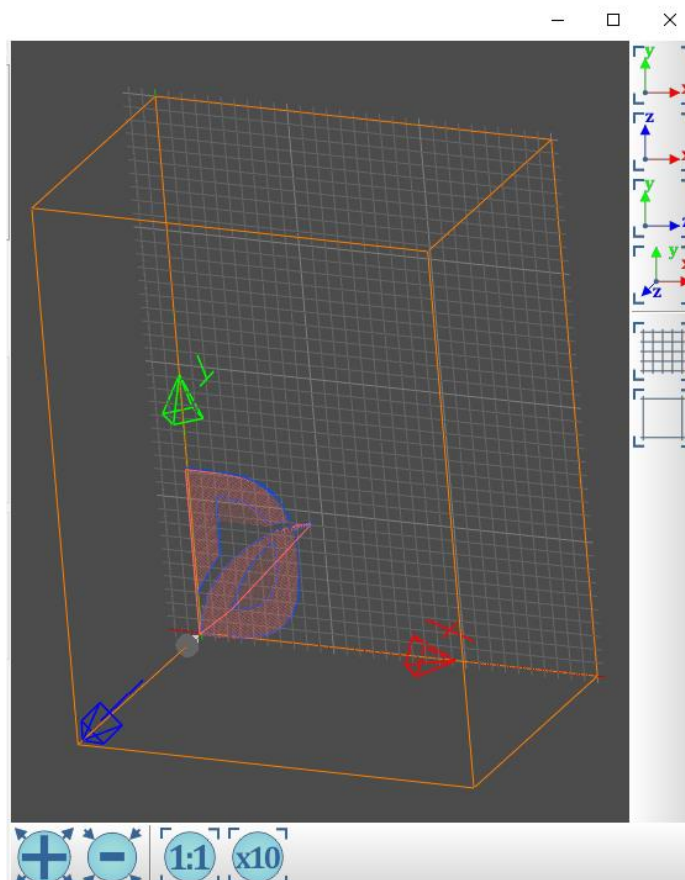

According to these settings in the 3D model window, the dimensions of the axis will be displayed as a quadrilateral in each plane.

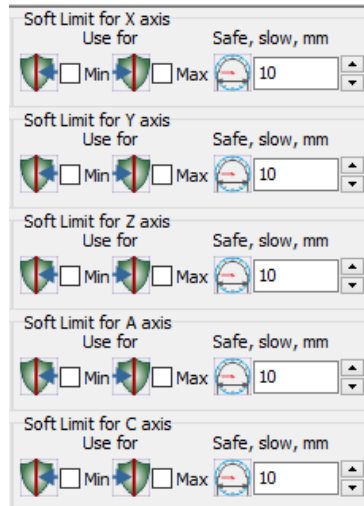

11.7.2. Soft limit

If you want the tool to stop when it reaches the minimum and maximum of your axis, use the appropriate constraints. These settings are designed to not damage your machine.



 - when the minimum limit of your axis is reached, the tool movement will stop and prevent it from moving towards the minimum.

 - when the maximum limit of your axis is reached, the tool will stop moving and prevent it from moving towards the maximum.

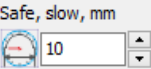
 - if the specified value remains before reaching the minimum or maximum, the tool speed is reduced to the minimum.

11.7.3. Home function

With these settings you can set the driving direction, priority and speed.

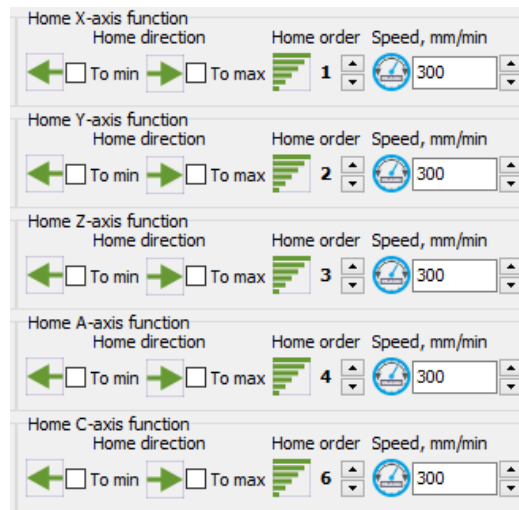

These settings are for buttons  on the main window.

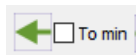

- when searching for the home position, the instrument will move to the minimum.

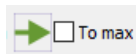

- when searching for the home position, the instrument will move to the maximum.

Attention! If you have turned on both the “To min” and “To max” settings, then when searching for the home position, the instrument will first move to the minimum and then to the maximum.

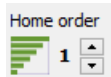

- allows you to specify the order in which the search for the home position is performed for each axis.

home order = 1 will be executed very first.

home order = 6 will be executed most recently.

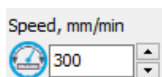

is the speed of the tool when searching for the home position.

12. Run the control program (G-code)

To run the control program in the language of G-code, you must click on the button with the image of the folder , then select the file.

If the file is recognized successfully, the three-dimensional model of the file will be displayed in the right part of the main window.

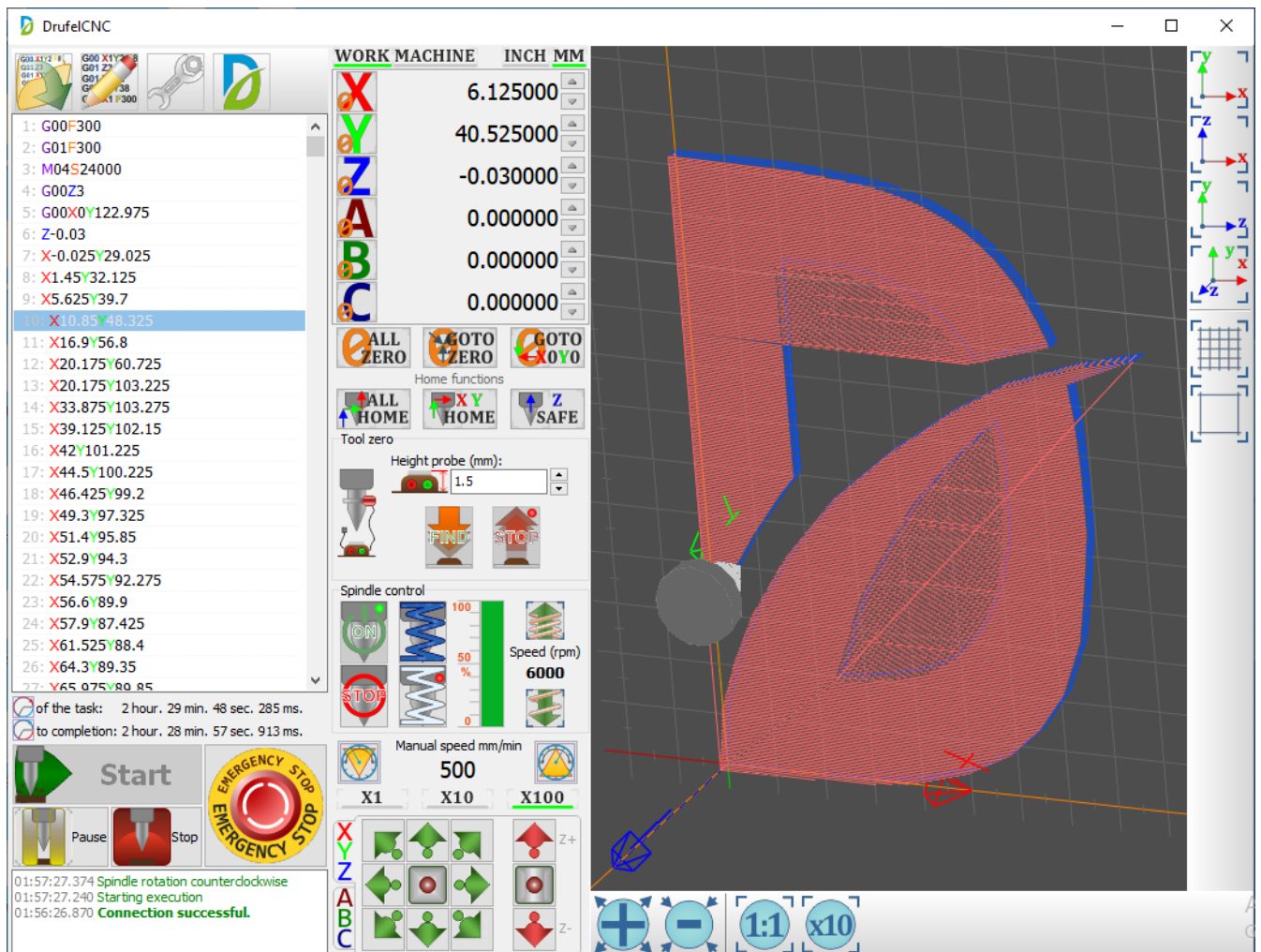

To start processing, click "Start" .

13. Search tool zero

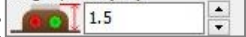
To begin searching for a tool zero, set the height  of the probe

used. Next, click . Wait until the end of the process.

First you need to configure the input port number for the probe. The Z axis is assigned according to the value found and the height of the probe.

After completing the tool zero search, the tool will return to its original position.

To cancel the tool zero search, click .

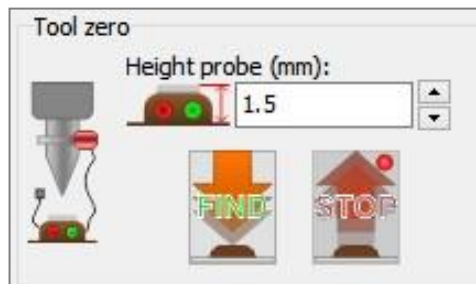

For the tool zero search to work correctly, you must set the input port number in accordance with the port number on the controller where your probe is connected. Set "Invert" so that the "Value now" in the normal state of the Probe is "Low".

Name	Port number	Invert	Value now	Hot Key
Main Input Ports				
<input type="checkbox"/> Emergency stop	1	<input checked="" type="checkbox"/> Yes	<input checked="" type="checkbox"/> Active	<input type="checkbox"/> None
<input type="checkbox"/> Smooth stop	0	<input type="checkbox"/> No	<input checked="" type="checkbox"/> Low	<input type="checkbox"/> None
<input type="checkbox"/> Pause	0	<input type="checkbox"/> No	<input checked="" type="checkbox"/> Low	<input type="checkbox"/> None
<input type="checkbox"/> Start	0	<input type="checkbox"/> No	<input checked="" type="checkbox"/> Low	<input type="checkbox"/> None
<input checked="" type="checkbox"/> Probe	2	<input type="checkbox"/> No	<input checked="" type="checkbox"/> Low	
X axis				
<input type="checkbox"/> Limit X+	3	<input checked="" type="checkbox"/> Yes	<input checked="" type="checkbox"/> Active	
<input type="checkbox"/> Limit X-	3	<input checked="" type="checkbox"/> Yes	<input checked="" type="checkbox"/> Active	
<input type="checkbox"/> Home X	3	<input checked="" type="checkbox"/> Yes	<input checked="" type="checkbox"/> Active	
Y axis				
<input type="checkbox"/> Limit Y+	4	<input checked="" type="checkbox"/> Yes	<input checked="" type="checkbox"/> Active	
<input type="checkbox"/> Limit Y-	4	<input checked="" type="checkbox"/> Yes	<input checked="" type="checkbox"/> Active	
<input type="checkbox"/> Home Y	4	<input checked="" type="checkbox"/> Yes	<input checked="" type="checkbox"/> Active	
Z axis				
<input type="checkbox"/> Limit Z+	5	<input checked="" type="checkbox"/> Yes	<input checked="" type="checkbox"/> Active	
<input type="checkbox"/> Limit Z-	5	<input checked="" type="checkbox"/> Yes	<input checked="" type="checkbox"/> Active	

Hotkey settings: Ctrl + A, Use default keys (checked), Use global hotkeys (unchecked).

Input port diagnostics: In0, In1, In2, In3, In4, In5, In6, In7, In8, In9, In10, In11, In12, In13, In14, In15, In16, In17, In18, In19, In20, In21, In22, In23, In24, In25, In26, In27, In28, In29, In30, In31. Legend: Low (red square), Active (green square).

14. Manual control



This field sets the speed of movement of the instrument during manual operation.



- Speed reduction button.



- Speed increase button.

X1

- 1% of the set speed or minimum speed.

X10

- 10% of the set speed.

X100

- 100% of the set speed.

The current speed is highlighted in green (**X100**).

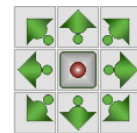

For manual control, press the corresponding joystick button



15. Spindle control and cooling



- Spindle power button.



- Spindle off button.

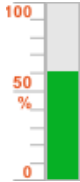

To set the spindle speed, click on the progress bar area.



- Button to increase the rotation of the spindle.





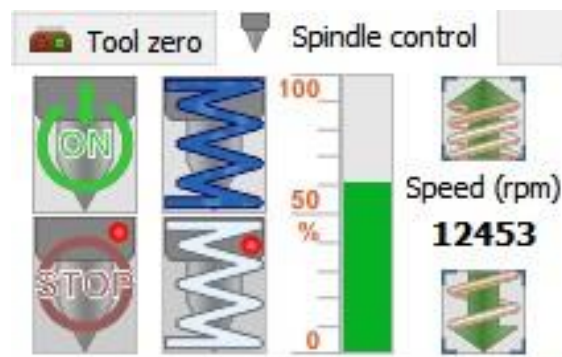





- Button to reduce the rotation of the spindle.



16. Assignment of coordinates















To reset the x-axis, click the button . To reset the remaining coordinates, click on similar buttons.

To set your own X coordinate axis, click the digital value of the X coordinate axis.     . In the field that appears, enter the desired value and click on the button . To cancel the entry, click .

Use the buttons to set more accurate coordinates  . To set the values of the remaining coordinates, use the same action algorithm.

To reset all coordinates, click on the button .

To move the tool to zero coordinates, click . To go to the coordinates X0 and Y0, click on the button .

WORK MACHINE	INCH	MM
	88.783750	 
	33.080000	 
	12.545625	 
	12.871875	 
		

16.1.Measurement system

The default system of units is millimeters. To set the units in inches, click **INCH** **MM**. To set the system of units in millimeters, click **INCH** **MM**. The current coordinate system is highlighted in green.

16.2. Machine coordinates

<u>WORK</u>	<u>MACHINE</u>	<u>INCH</u>	<u>MM</u>
X	0.746250		
Y	0.000000		
Z	5.000000		
A	-0.871875		

The machine coordinates are the actual coordinates of your axes.

These coordinates are used to define the limits and dimensions of the machine.

If machine coordinates are activated for display, they are highlighted in green

MACHINE.

16.3. Work coordinates

<u>WORK</u>	<u>MACHINE</u>	<u>INCH</u>	<u>MM</u>
X	88.783750		
Y	33.080000		
Z	12.545625		
A	12.871875		

Work coordinates are relative to machine coordinates.

These are the coordinates at which the g-code is executed by default.

If work coordinates are activated for display, they are highlighted in green

WORK.

17. Display 3D model

The code you downloaded is displayed as a 3D model on the right side of the application window.

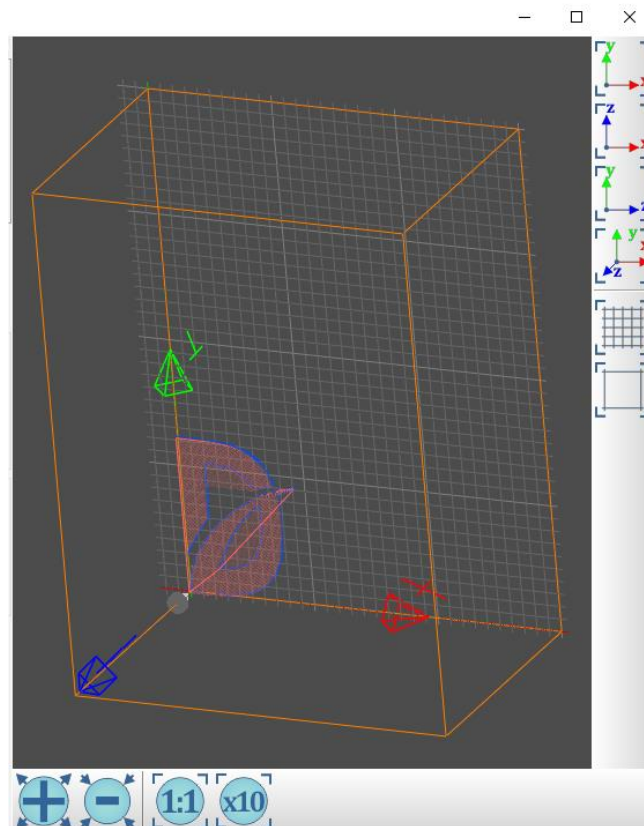

To rotate the 3D model, move the mouse pointer to the display area of the 3D model. Right-click and hold to move the mouse pointer. You can also use

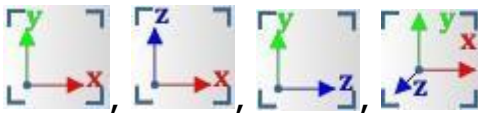
additional buttons. . To zoom the 3D model, use

the mouse wheel or . To move the model in the plane, use the left mouse button.

To turn on the grid, click on the button . In order to turn off the grid, click

on the button . Grid enabled by default.

18. Opening HPGL files

To open files in HPGL format, you must click on the button with the image of the folder , then select the file.

In the window that opens, you must select the parameters for converting HPGL to G-code.

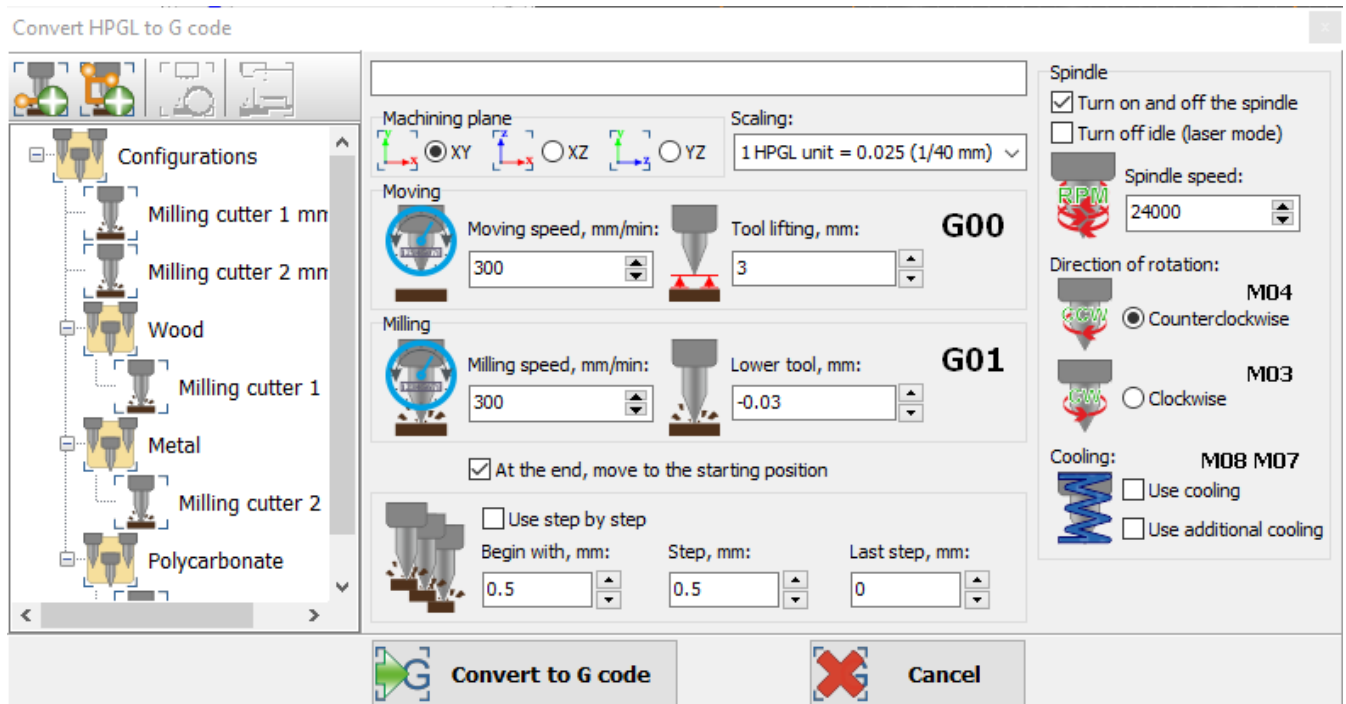

After successful conversion, you will see a three-dimensional model of the file.



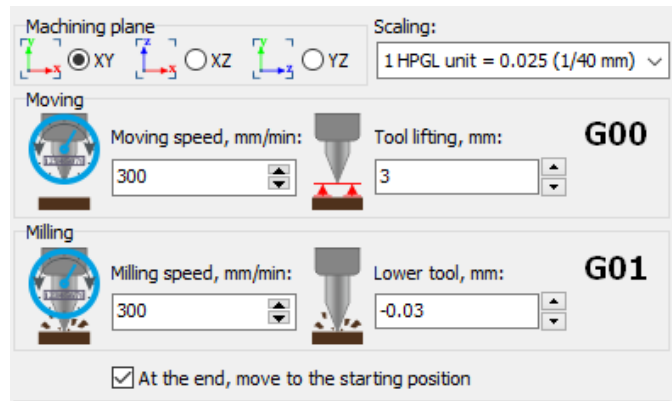

19. Basic parameters of the HPGL file converter

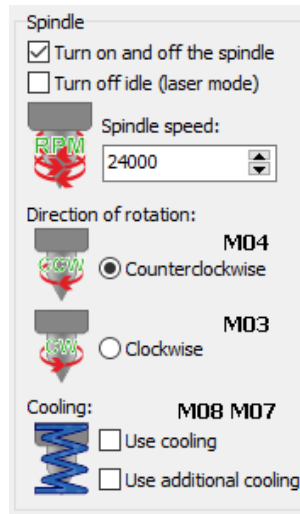

	The plane in which the HPGL file will be executed.
	The scale corresponds to one HPGL unit per millimeter.
	Tool travel speed without milling. Moving between milling areas.
	The speed at which the tool moves when milling. Model milling speed.
	Tool position when moving to the milling area.
	Tool position when milling the model.

19.1. Spindle settings of HPGL file converter



<input checked="" type="checkbox"/> Turn on and off the spindle	<p>The spindle will turn on when the HPGL file starts executing, the spindle turns off when the HPGL file finishes executing.</p>
<input type="checkbox"/> Turn off idle (laser mode)	<p>The spindle will only work when milling. This setting is suitable for laser or plasma operation.</p>
 Spindle speed: 24000	<p>The spindle speed while executing the HPGL file. When using a laser, sets the laser power.</p>
Direction of rotation:  M04 <input checked="" type="radio"/> Counterclockwise	<p>The direction of rotation of the spindle is counterclockwise when executing the HPGL file. Corresponds to command M04.</p>
 M03 <input type="radio"/> Clockwise	<p>The direction of rotation of the spindle is clockwise when executing the HPGL file. Corresponds to command M03.</p>
Cooling: M08 M07  <input type="checkbox"/> Use cooling <input type="checkbox"/> Use additional cooling	<p>Cooling will be turned on before executing the HPGL file. Corresponds to commands M08 and M07.</p>

19.2. Use step by step

With the help of "Use step by step" you can set up step-by-step milling (cutting) of models. This will reduce the negative impact on the cutter.

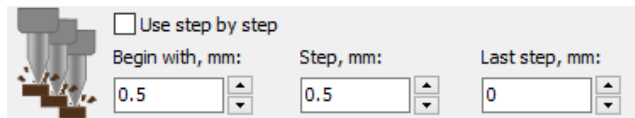

<p>Begin with, mm:</p> <input type="text" value="0.5"/>	<p>After this axis position, the step milling algorithm will start. For example after $Z = 0.5$ mm.</p>
<p>Step, mm:</p> <input type="text" value="0.5"/>	<p>The cutter will move this distance after each cycle through the entire HPGL file. For example, 0.5 mm.</p>
<p>Last step, mm:</p> <input type="text" value="0"/>	<p>If necessary, you can set a fixed distance for the last step.</p>

20. Generating a G-code from an image

To open a file in the format (png, jpeg, gif, bmp), you must click on the button with the image of the folder , or select the necessary file and transfer it to the G-code field.

In the window that opens, you must select the options for converting the image into a G-code.

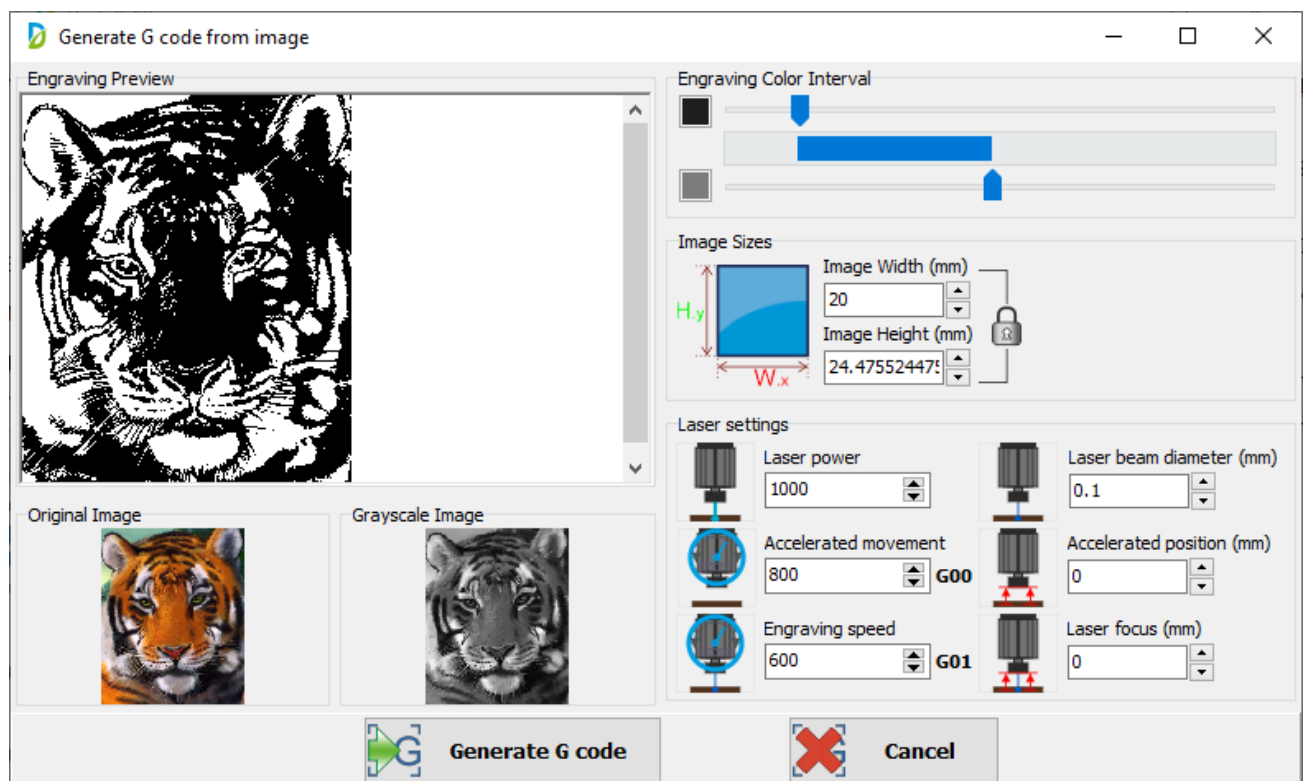

In the engraving color interval block, you can adjust the color interval.

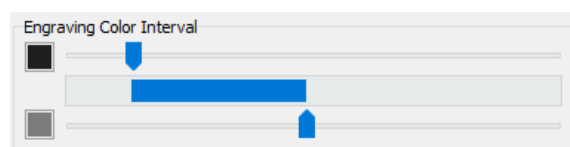

In the Image Sizes block, you can adjust the image size.

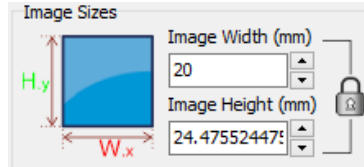

 - proportional image resizing.

 - not proportional image resizing.

In the Laser Settings block, you can configure the laser settings.

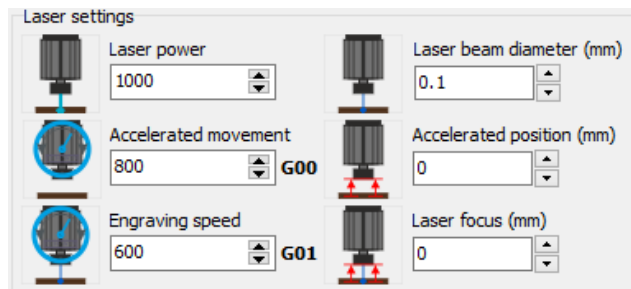

 - laser power setting

 - laser beam diameter adjustment (mm)

 - accelerated motion setting (G00)

 - accelerated position adjustment (mm)

 - engraving speed setting

 - laser focus adjustment

21. Stepper motors

If your stepper motors don't rotate

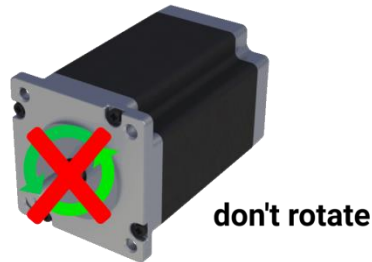

Turn on Step Invert Step Invert

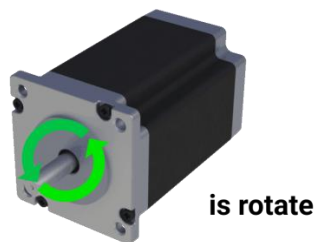

If you doubt the correct connection of ENA + ENA- then temporarily do not connect it. Make sure your motors spin. The default ENA port is activated on most stepper motor drivers.

