

UNI-T®

UTG9000C-II Series Function/Arbitrary Waveform Generator User Manual



Introduction

Dear Users:

Hello! Thank you for choosing this brand new UNI-T device. In order to safely and correctly use this instrument, please read this manual thoroughly before use, especially the Safety Information part.

After reading this manual, it is recommended to keep the manual at an easily accessible place, preferably close to the device, for future reference.

Copyright Information

- UNI-TREND TECHNOLOGY (CHINA) CO., LTD., all rights reserved.
- UNI-T products are protected by patent rights in China and foreign countries, including issued and pending patents.
- UNI-T reserves the rights to any product specification and pricing changes.
- UNI-T reserves all rights. Licensed software products are properties of UNI-T and its subsidiaries or suppliers, which are protected by national copyright laws and international treaty provisions. Information in this manual supersedes all previously published versions.
- UNI-T is the registered trademark of UNI-TREND TECHNOLOGY (CHINA) CO., LTD.
- If the original purchaser sells or transfers the product to a third party within three years from the date of purchase of the product, the warranty period of three years shall be from the date of the original purchase from UNI-T or an authorized UNI-T distributor. Accessories and fuses, etc. are not included in this warranty.
- If the product is proved to be defective within the warranty period, UNI-T reserves the rights to either repair the defective product without charging of parts and labor, or exchange the defected product to a working equivalent product (determined by UNI-T). Replacement parts, modules and products may be brand new, or perform at the same specifications as brand new products. All original parts, modules, or products which were defective become the property of UNI-T.

The “customer” refers to the individual or entity that is declared in the guarantee. In order to obtain the warranty service, "customer" must inform the defects within the applicable warranty period to UNI-T, and perform appropriate arrangements for the warranty service. The customer shall be responsible for packing and shipping the defective products to the designated maintenance center of UNI-T, pay the shipping cost, and provide a copy of the purchase receipt of the original purchaser. If the product is shipped domestically to the location of the UNI-T service center, UNI-T shall pay the return shipping fee. If the product is sent to any other location, the customer shall be responsible for all shipping, duties, taxes, and any other expenses.

- This warranty shall not apply to any defects, malfunction or damages caused by accidental, machine parts’ wear and tear, using outside the product’s specifications, improper use, and improper or lacking of maintenance. UNI-T under the provisions of this warranty has no obligation to provide the following services:
 - a) Any repair damage caused by the installation, repair, or maintenance of the product by non UNI-T service representatives.
 - b) Any damage caused by improper use or connection to an incompatible device.
 - c) Any damage or malfunction caused by the use of a power source not provided by UNI-T.
 - d) Any maintenance on altered or integrated products (if such alteration or integration leads to an increase in time or difficulty of product maintenance).
- This warranty is written by UNI-T for this product and it is used to substitute any other express or implied warranties. UNI-T and its distributors do not offer any implied warranties for merchantability or applicability purposes. For violation of this guarantee, UNI-T is responsible for the repair or replacement of defective products as the only and complete remedy available to customers. Regardless of whether UNI-T and its distributors are informed that any indirect, special, incidental, or consequential damage may occur, the UNI-T and its distributors shall not be responsible for any of these damages.

Contents

Chapter 1 Safety Information -----	2	3.4.3 Key Sound -----	7
1.1 Safety Terms and Symbols -----	2	3.4.4 Factory Settings -----	7
1.2 General Safety Overview -----	2	3.5 Count -----	8
Chapter 2 UTG9000C-II Series Introduction -----	3	Chapter 4 Advanced Applications -----	8
2.1 Main Features -----	3	4.1 Output Modulation Waveform -----	8
2.2 Output Characteristics -----	3	4.1.1 Amplitude Modulation (AM) -----	8
2.3 Panel and Keys Introduction -----	4	4.1.2 Frequency Modulation (FM) -----	12
2.3.1 Front Panel -----	4	4.2 Output Frequency Sweep Waveform -----	15
2.3.2 Back Panel -----	5	4.2.1 Select Frequency Sweep -----	15
2.3.3 Function Interface -----	5	4.2.2 Set Start and Stop Frequency -----	15
Chapter 3 Quick Start -----	6	4.2.3 Frequency Sweep Mode -----	16
3.1 General Inspection -----	6	4.2.4 Frequency Sweep Time -----	16
3.1.1 Inspect Whether Damage is Caused by Transportation -----	6	4.2.5 Select Trigger Source -----	16
3.1.2 Inspect Accessories -----	6	4.2.6 Comprehensive Example -----	16
3.1.3 Inspect Complete Machine -----	6	4.3 Output Arbitrary Wave -----	18
3.2 Adjust The Handle -----	6	4.3.1 Enable Arbitrary Wave Function -----	18
3.3 Output Basic Waveform -----	6	4.3.2 Select Arbitrary Wave -----	18
3.3.1 Set Output Frequency -----	6	4.4 Power Amplifier Output -----	18
3.3.2 Set Output Amplitude -----	6	Chapter 5 Fault Handling -----	18
3.3.3 Set DC Offset Voltage -----	7	5.1 No Display on Screen (Blank Screen) -----	18
3.3.4 Set Phase -----	7	5.2 No Waveform Output -----	18
3.3.5 Set Pulse Wave Duty Ratio -----	7	Chapter 6 Service and Support -----	19
3.3.6 Set Ramp Duty -----	7	6.1 Warranty Overview -----	19
3.3.7 Set DC Voltage -----	7	6.2 Contact Us -----	19
3.3.8 Set Noise Wave -----	7	Appendix A: Factory Reset State -----	20
3.4 System Settings -----	7	Appendix B: Performance Index -----	21
3.4.1 Output Impedance settings -----	7	Appendix C: List of Accessories -----	24
3.4.2 Screen Brightness -----	7	Appendix D: Maintenance and Cleaning -----	24
		Appendix E: Chinese-English Parameter Comparison Table -----	25

Chapter 1 Safety Information

1.1 Safety Terms and Symbols

The following terms may appear in this manual:

Warning: Indicates the conditions and behaviors that may endanger life.

Note: Indicates the conditions and behaviors that may cause damage to the product and other properties.











The following terms may appear on the product:

Danger: Performing this operation may cause damage.

Warning: Performing this operation may be dangerous.

Note: Performing this operation may cause damage to the product and other devices connected to the product.

The following symbols may appear on the product:

	AC
	Measuring ground terminal
	Shell ground terminal
	Danger! High voltage
	Caution: please refer to the manual
	Protective ground terminal
	CE marking is an EU certification marking
	C-tick is an Australian certification marking
	Environmental protection use period (EPUP)
	ETL is USA certification marking.
	WEEE Recovery marking

1.2 General Safety Overview

This instrument strictly complies with the IEC 61010-1 safety standards during design and manufacturing. It also conforms to the safety standards of insulation overvoltage standard CAT0 and pollution level II.

Please read the following preventive safety measures:

- In order to prevent electric shock or fire, please use power cord and adapter dedicated to this product and approved by the country.
- This product is grounded through protective ground wire in the power cord. In order to prevent electric shock, please check whether the power socket is connected to the earth before use. Please ensure that the protective ground terminal is reliably connected to the ground terminal of power source before connecting any input or output terminal other than the power cord.
- To avoid personal injury and prevent damage to the product, only personnel that have received professional training can execute maintenance procedures.
- In order to prevent fire or electric shock, please pay attention to the product's rated working range and marking. It is forbidden to work outside the rated ranges.
- Inspect whether accessories suffer from mechanical damage before use. If so, please replace them.
- Use only accessories provided for the product.
- Do not insert metal objects into input or output terminal of the product.
- If you doubt that the product is damaged, please ask qualified maintenance personnel to inspect.
- Do not operate this product when the instrument case is open.
- Do not operate in a humid environment.
- Keep the surface of product clean and dry.

Chapter 2 UTG9000C-II Series Introduction

The UTG9000C-II Series Function/Arbitrary Waveform Generator uses the direct digital synthesis technology, which can generate the accurate, stable, pure and low-distortion waveform output, and the resolution is as low as 1 μ Hz. It is an economical, high-performance and multifunctional function/arbitrary waveform generator. With the convenient operation interface, excellent technical indicators and humanized graphic display, this multi-purpose equipment can meet your learning and testing requirements and improve work efficiency.

2.1 Main Features

- ▶ 5MHz/2MHz sine wave and pulse wave output, full-band resolution of 1 μ Hz
- ▶ Built-in power amplifier with full power bandwidth up to 200kHz, maximum output power is 4W
- ▶ DDS implementation with 125MSa/s sampling rate and 14bits vertical resolution
- ▶ 6-digit high precision frequency meter compatible with TTL level signal
- ▶ 20 sets of non-volatile digital arbitrary waveform memory
- ▶ Easy-to use modulation types: AM, FM
- ▶ Support frequency sweeping output
- ▶ Powerful upper computer software
- ▶ Ultra-black EBTN LCD display
- ▶ Standard configuration interface: USB Device
- ▶ Internal/external modulation, internal/external trigger

2.2 Output Characteristics

Channel	CHA
Amplitude Range	1mVpp ~ 10Vpp (50 Ω)
Waveform	Sine wave, pulse wave, ramp wave, arbitrary wave, noise, DC
Modulation	AM, FM
Frequency Sweep	Log, Line

UTG9000C-II User Manual

2.3 Panel and Keys Introduction

2.3.1 Front Panel

This product provides a simple, intuitive, easy-to-use front panel, as shown below:

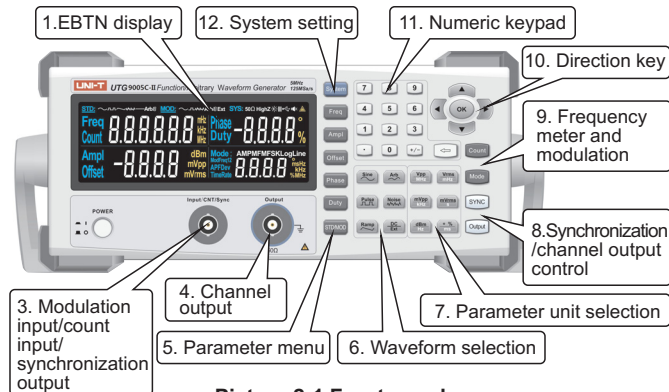

Picture 2-1 Front panel

1. Display Screen
EBTN LCD
2. Power On/Off
Turn the instrument on or off.
3. Modulation Input/ Frequency Meter Input/ Synchronization Output
 - 1) In AM, FM or frequency sweep, when the modulation source is selected as external, the modulation signal is input through the external modulation input terminal.
 - 2) When the frequency meter function is enabled, the signal to be measured is input through this interface.

- 3) When the modulation (or the modulation source is internal) and the frequency meter is turned off, the device will output the synchronization signal through this interface.
4. Channel Output
Signal source channel output terminal.
5. Parameter Menu
Set waveform parameters.
6. Waveform Selection
Waveform type quick selection key
7. Parameter Unit
Select the corresponding unit after entering the channel parameter value.
8. Synchronization/Channel Output Control
[SYNC] is the synchronization signal output button; [Output] is the signal output button. Short press [Output] to turn on/off the signal source channel output; long press [Output] to turn on the power module output channel, short press to turn off the output.
Note: The channel output terminal is set with overvoltage protection, which is performed when one of the following conditions is met:
Amplitude setting value > 625mVpp, input voltage > | 12.5V | , frequency < 10kHz.
Amplitude setting value ≤ 625mVpp, input voltage > | 2.5V | , frequency < 10kHz.
* When overvoltage protection occurs, the warning indicator Δ on the upper right corner of the screen flashes for 3 seconds and the buzzer beeps.
9. Frequency Meter and Modulation
[Count] is the frequency meter button, [Mode] is the modulation button.
10. Direction Key
Used to increase or decrease numbers, move cursors, switch waveforms, and confirm, etc.
11. Numeric Keyboard
Used to enter the required parameters, including numeric keys 0 to 9, decimal point ".", and symbolic keys "+/-", "<=>".
12. System
System setting button

2.3.2 Back Panel

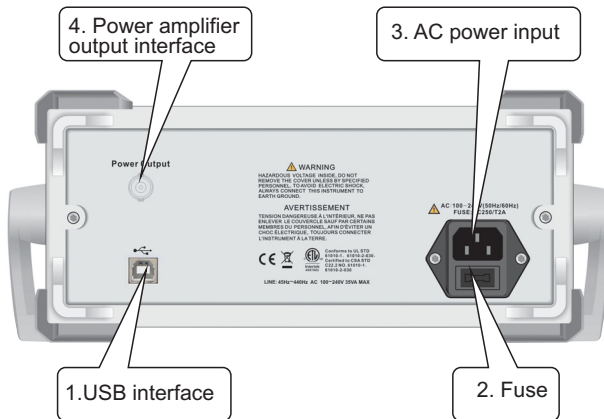

Picture 2-2 Back panel

1. USB Interface

Connect to the upper computer through this USB interface.

2. Fuse

When the AC input current exceeds 2A, the fuse blows to cut off the AC input to protect the instrument.

3. AC Power Input

The rated input of this product is: 100~240V, 45~440Hz; power fuse: 250V, T2 A.

4. Power Amplifier Output Interface

Built-in power amplifier output interface.

5

2.3.3 Function Interface

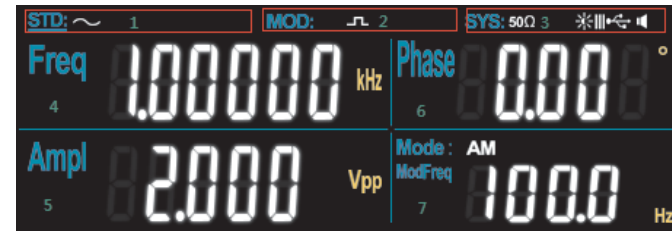

Picture 2-3 Function interface

1. STD: Abbreviation of Standard, fundamental wave display information. STD indicates that the waveform type is in the carrier wave state.
2. MOD: Modulation display information, MOD indicates that the waveform type is in the modulation wave state.
3. System: System setting. **50Ω** indicates that the output impedance is 50Ω, ☼ indicates the screen brightness, USB indicates that the device is connected to the computer through USB device, 🔊 indicates the button sound is turned on.
4. Fundamental wave frequency setting and Count (frequency meter) display.
5. Fundamental wave amplitude setting and DC bias setting.
6. Fundamental wave phase and duty ratio settings.
7. Modulation mode and modulation parameter settings.

Chapter 3 Quick Start

3.1 General Inspection

When you get a new function/arbitrary waveform generator, you are advised to inspect the instrument according to the following steps.

3.1.1 Inspect Whether Damage is Caused by Transportation

If the packaging carton or foamed plastic supplementary mat is seriously damaged, please contact with dealer of the product or local office.

If the instrument is damaged during transportation, please keep the package, and notify transportation department and dealer of the product, who will arrange repair or replacement.

3.1.2 Inspect Accessories

UTG9000C-II accessories include: a power cord, a USB data cable, a BNC cable (1m), a user CD and a product warranty card.

In case of lack or damage of accessories, please contact with dealer of the product or local office.

3.1.3 Inspect Complete Machine

If appearance of the instrument is damaged, the instrument runs abnormally or fails to pass performance tests, please contact with dealer of the product or local office.

3.2 Adjust The Handle

The handle position of the UTG9000C-II Series DDS Function/Arbitrary Waveform Generator can be adjusted freely. Just hold the handle on both sides and pull outwards, then rotate the handle to the desired position.

As shown in picture 3-1 below:

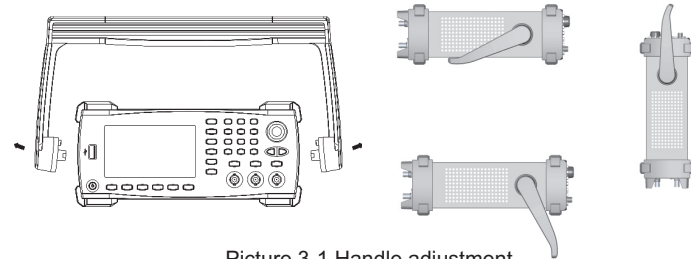

Picture 3-1 Handle adjustment

3.3 Output Basic Waveform

3.3.1 Set Output Frequency

The default configuration of waveform is a sine wave with frequency of 1kHz and amplitude of 100mVpp (terminating at 50Ω).

The specific steps for changing frequency into 2.5MHz are as follows: Press the **[Freq]** button, and use the numeric keypad to enter 2.5, then select the parameter unit **[Vpp/mHz]**.

3.3.2 Set Output Amplitude

The default configuration of waveform is a sine wave with amplitude of 100mVpp (terminating at 50Ω).

The specific steps for changing amplitude into 300mVpp are as follows: Press the **[Ampl]** button, and use the numeric keypad to enter 300, then select the parameter unit **[mVpp]**.

3.3.3 Set DC Offset Voltage

The default configuration of waveform is a sine wave with DC offset voltage of 0V (terminating at 50Ω). The specific steps for changing DC offset voltage into -150mV are as follows:

Press the **[Offset]** button, and use the numeric keypad to enter -150, then select the parameter unit .

3.3.4 Set Phase

The default phase of the waveform is 0°. To set the phase to 90°, press the **[Phase]** button, and use the numeric keypad to enter 90, then select the parameter unit .

3.3.5 Set Pulse Wave Duty Ratio

The pulse wave default frequency is 1kHz, duty ratio is 50%. To set the duty ratio (limited by the minimum pulse width specification of 80ns) to 25%, the specific steps are as follows:

Press **[Pulse]** → **[Duty]**, and use the numeric keypad to enter 25, then select the parameter unit .



3.3.6 Set Ramp Duty

The default frequency of the ramp wave is 1kHz. To set the triangular wave with a duty of 75%, the specific steps are as follows:



Press **[Ramp]** → **[Duty]**, and use the numeric keypad to enter 75, then select the parameter unit .

3.3.7 Set DC Voltage

The default DC voltage is 0V. To change the DC voltage to 3V, the specific steps are as follows:

Press the  button, and use the numeric keypad to enter 3, then select the parameter unit .



3.3.8 Set Noise Wave

The system defaults to the quasi-Gaussian noise with an amplitude of 100mVpp and a DC offset of 0V. To set the quasi-Gaussian noise with an amplitude of 300mVpp and a DC offset of 1V, the specific steps are as follows: Press **[Noise]** → **[Ampl]**, use the numeric keypad to enter 300, and select the parameter unit ; then press **[Offset]**, and use the numeric keypad to enter 1, then select the parameter unit .

3.4 System Settings

The system settings can be used to adjust the impedance, screen brightness, key sound, and restore to the factory settings.

3.4.1 Output Impedance settings

Press the **[System]** button, 50Ω or HighZ is selected, press  or  to switch the impedance between 50Ω and HighZ.

3.4.2 Screen Brightness

Press **[System]** and , and select  by the cursor, then press  or  to adjust the brightness of the screen display.

The screen brightness has three scales: 10%, 50%, and 100%.

3.4.3 Key Sound

Press the **[System]** button, then press  until  is selected, press  or  to turn on or off the key sound.

3.4.4 Factory Settings

Press the **[System]** button, then press  until  is selected, long press the **[OK]** key for 3 seconds to restore factory settings.

3.5 Count

This function/arbitrary waveform generator can measure the frequency and duty ratio of the signal which is compatible with the TTL level. The range of frequency measurement is 100mHz~100MHz. When frequency meter is used, the signal compatible with TTL level is input through the Input/CNT/Sync connector.

Press the **Count** button, the device will read the signal “frequency” and “duty ratio” values. When no signal is input, the count parameter always displays the value measured last time.

The count parameter refreshes the display only when you input a signal that is compatible with the TTL level to the Input/CNT/Sync connector.

Chapter 4 Advanced Applications

This chapter introduces the AM, FM modulation. Press the **Mode** key to enter modulation, and press the **Mode** key again to exit.

4.1 Output Modulation Waveform

4.1.1 Amplitude Modulation (AM)

Select AM modulation

Press the **Mode** button, then move the cursor to AM by **▶** and press **OK** to enable AM. AM modulation is selected by default when the modulation is on. Then the instrument will output the modulated waveform with the currently set modulation wave and carrier wave.

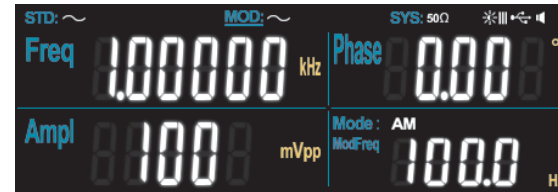

Picture 4-1 Enable AM modulation

Select carrier waveform

The carrier waveform can be: sine wave, pulse wave, ramp wave or arbitrary wave, the default is sine wave. After selecting the AM modulation, press the **STD/MOD** button and STD is selected.

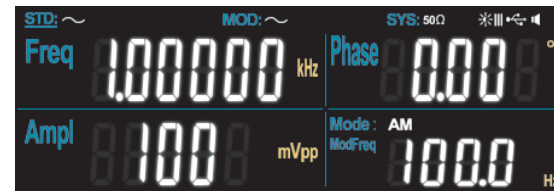

Picture 4-2 Set AM carrier waveform

Select the carrier waveform by pressing the waveform selection button:



Set carrier frequency

Carrier frequency range varies with carrier waveform. The default frequency of all carrier waves is 1kHz. See the table 4-1 below for the carrier wave frequency ranges:

Table 4-1:

Carrier waveform	Frequency			
	UTG9002C-II		UTG9005C-II	
	Min	Max	Min	Max
Sine wave	1 μ Hz	2MHz	1 μ Hz	5MHz
Square wave	1 μ Hz	2MHz	1 μ Hz	5MHz
Ramp wave	1 μ Hz	200kHz	1 μ Hz	200kHz
Arbitrary wave	1 μ Hz	1MHz	1 μ Hz	1MHz

To set the carrier frequency, when the STD carrier wave is selected, press the Freq button and enter the required value, then select the unit to complete.

Select modulation source

UTG9000C-II Function/Arbitrary Waveform Generator can select internal or external modulation source. After the AM function is enabled, the modulation source is internal by default.

You can change the modulation source to external by pressing the  key when the MOD modulation is selected, the task bar of modulation information on the upper part of the screen will display the “Ext” symbol. To exit EXT, just press the sine, pulse, arbitrary, or noise key.

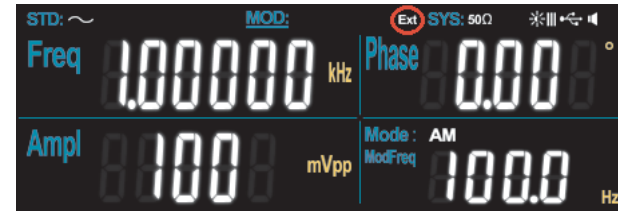

Picture 4-3 Select AM modulation source

1) Internal source

- When modulation source is selected as internal, the modulation wave can be: sine wave, pulse wave, arbitrary wave, and noise.
Pulse wave: duty ratio is 50%.
- Arbitrary wave: when selecting arbitrary wave as modulation waveform, the built-in 20 arbitrary waveforms can be selected using the keypad or direction keys.
- Noise: white Gaussian noise.

2) External source

When modulation source is selected as external, modulation wave and frequency options will be hidden in parameter list, and an external waveform will be used to modulate the carrier waveform.

The AM modulation amplitude is controlled by the $\pm 5V$ signal level on the external modulation input terminal and the modulation depth.

For example, if modulation depth is set to be 100%, AM output amplitude is the largest when external modulation signal is +5V and the smallest when external modulation signal is -5V.

UTG9000C-II User Manual

Set modulation frequency

When the modulation source is selected as internal, the frequency of the modulation wave can be set in the range of 2mHz~50kHz (default is 100Hz). When AM is enabled and the MOD modulation is selected, press the **▶** key to move the cursor to ModFreq and press the **OK** button, then enter the required value and select the unit, press **OK** again to confirm.

When the modulation source is selected as external, the modulation wave and frequency options will be hidden in parameter list, and an external waveform will be used to modulate the carrier waveform. The frequency range of the external input modulation signal is 0Hz~20kHz.

Set modulation depth

Modulation depth refers to the degree of amplitude change, which is expressed in percentage. The range of AM modulation depth is 0%~120%, 100% by default.

- ▶ When modulation depth is 0%, a constant amplitude is output (half of the set carrier amplitude).
- ▶ When modulation depth is 100%, the output amplitude varies with the modulation waveform.
- ▶ When modulation depth is greater than 100%, the output amplitude of the instrument will not exceed 10Vpp (load of 50Ω).

To change the modulation depth, when AM is enabled and the MOD modulation is selected, press the **▼** key to move the cursor to A Dev and press **OK**, then enter the required value and select the unit, press the **OK** key again to confirm.

When the modulation source is selected as external, the instrument's output amplitude is also controlled by the $\pm 5V$ signal level of the external modulation input terminal (Input/CNT/Sync) on the front panel.

For example, if modulation depth is set to be 100%, AM output amplitude is the largest when external modulation signal is +5V and the smallest when external modulation signal is -5V.

Comprehensive example

First make the instrument run in amplitude modulation (AM) mode, and then set an internal sine wave of 200Hz as the modulation signal and a pulse wave with frequency of 10kHz, amplitude of 200mVpp and duty ratio of 45% as the carrier signal. Finally set modulation depth to be 80%. The specific

steps are as follows:

- 1) Enable amplitude modulation (AM) function

Press the **Mode** button, and move the cursor to AM by the **▶** key, press **OK** to enable AM.

- 2) Set modulation signal parameters

Follow step 1), press the **OK** key and use the numeric keypad to enter 200, then select the parameter unit **Hz**.

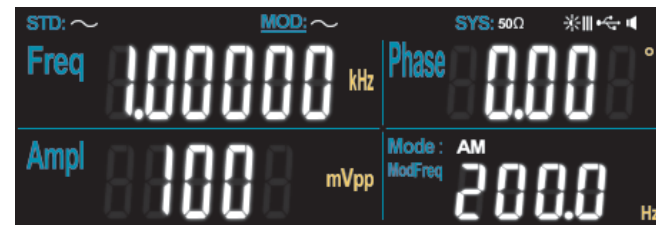

Picture 4-4 Set AM modulation frequency

3) Set carrier waveform and parameters

Press the **[STD/MOD]** soft key, the STD is selected, then press **[Pulse]** to select the pulse wave as the carrier wave.

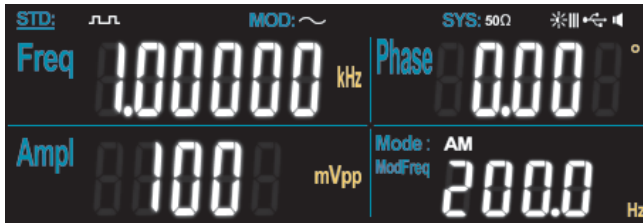

Picture 4-5 Set AM carrier waveform

Press the **[Freq]** button to set the frequency, then use the numeric keypad to enter 10 and select the parameter unit **[kHz]**.

Press **[Ampl]** to set the amplitude, use the numeric keypad to enter 200, then select the parameter unit **[mVpp]**.

Press **[Duty]** to set the duty ratio, use the numeric keypad to enter 45, then select the parameter unit **[%]**. As shown below:

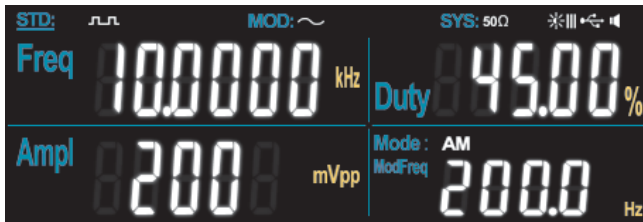

Picture 4-6 Set AM carrier parameters

4) Set modulation depth

After the carrier parameter settings are completed, press the **[STD/MOD]** button, MOD will be selected and you can perform the modulation depth settings:

Press **[A Dev]** to move the cursor to A Dev and press **[OK]**, then use the numeric keypad to enter 80, and select the parameter unit **[%]**.

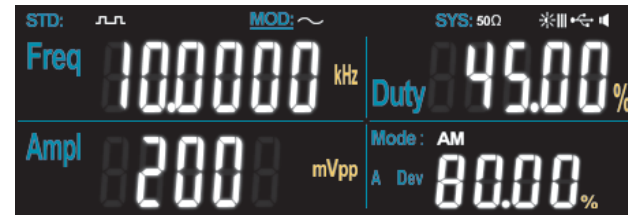

Picture 4-7 Set AM modulation depth

5) Enable channel output

Short press the **[Output]** button, if the backlight is on, it indicates the channel output is enabled.

The AM modulation waveform is shown below:

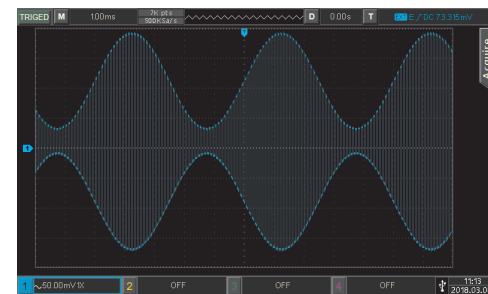

Picture 4-8 AM output waveform

UTG9000C-II User Manual

4.1.2 Frequency Modulation (FM)

In frequency modulation, the modulated waveform generally is composed of carrier wave and modulation wave. The frequency of carrier wave will vary with amplitude of modulation wave.

Press the **[Mode]** button, then move the cursor to FM by **▶** and press **[OK]** to enable FM. The instrument will output the modulated waveform with the currently set modulation wave and carrier wave.

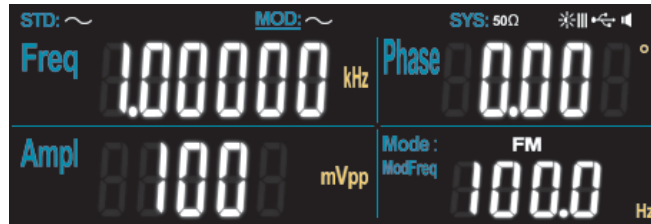

Picture 4-9 Enable FM modulation

Select carrier waveform

The carrier waveform can be: sine wave, pulse wave, ramp wave or arbitrary wave, the default is sine wave. After selecting the FM modulation, press the **[STD/MOD]** button and STD is selected.

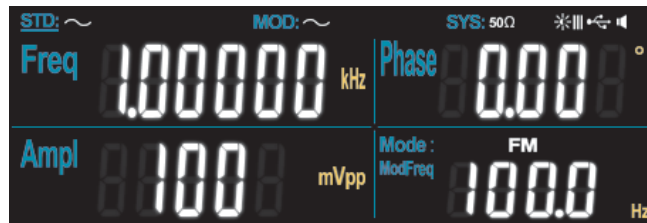

Picture 4-10 Set FM carrier waveform

Select the carrier waveform by pressing the waveform selection button:

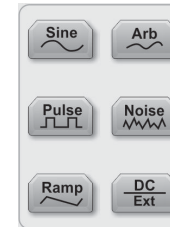

Set carrier frequency

Carrier frequency range varies with carrier waveform. The default frequency of all carrier waves is 1kHz. See table 4-2 below for frequency ranges of carrier waves:

Table 4-2:

Carrier waveform	Frequency			
	UTG9002C-II		UTG9005C-II	
	Min	Max	Min	Max
Sine wave	1μHz	2MHz	1μHz	5MHz
Square wave	1μHz	2MHz	1μHz	5MHz
Ramp wave	1μHz	200kHz	1μHz	200kHz
Arbitrary wave	1μHz	1MHz	1μHz	1MHz

To set the carrier frequency, when the STD carrier wave is selected, press the Freq button and enter the required value, then select the unit to complete.

Select modulation source

UTG9000C-II Function/Arbitrary Waveform Generator can select internal or external modulation source. After the FM function is enabled, the modulation source is internal by default.

You can change the modulation source to external by pressing the  key when the MOD modulation is selected, the task bar of modulation information on the upper part of the screen will display the “Ext” symbol. To exit EXT, just press the sine, pulse, arbitrary, or noise key.

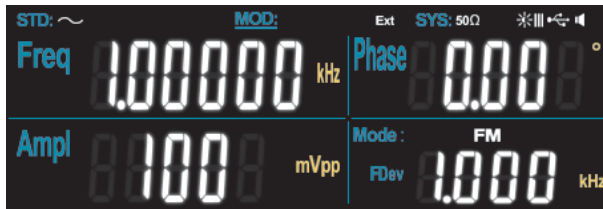

Picture 4-11 Select FM modulation source

1) Internal source



When internal modulation source is selected, the modulation wave can be: sine wave, pulse wave, arbitrary wave, and noise.

2) External source

When the external modulation source is selected, an external waveform will be used to modulate the carrier waveform. The FM frequency deviation is controlled by the $\pm 5V$ signal level on the external modulation input. The FM output frequency is greater than the carrier frequency at positive signal level and less than the latter at negative signal level. Lower external signal level generates less deviation.

For example, if frequency deviation value is set to be 1kHz, FM output frequency is 1kHz more than the current carrier frequency when external modulation signal is +5V and 1kHz less than the current carrier frequency when external modulation signal is -5V.



Set modulation frequency

When the modulation source is selected as internal, the frequency of the modulation wave can be set in the range of 2mHz~50kHz (default is 100Hz). When FM is enabled and the MOD modulation is selected, press the  key to move the cursor to ModFreq and press the  button, then enter the required value and select the unit, press  again to confirm.

When the modulation source is selected as external, the modulation wave and frequency options will be hidden in parameter list, and an external waveform will be used to modulate the carrier waveform. The frequency range of the external input modulation signal is 0Hz~20kHz.

Set frequency deviation

The frequency deviation indicates the deviation of the frequency of the waveform that has been FM modulated from the carrier frequency. The maximum frequency deviation can be set to half of the model's bandwidth. The system default frequency deviation is 1kHz.

To change the frequency deviation, when FM is enabled and the MOD modulation is selected, press the  key to move the cursor to F Dev and press , then enter the required value and select the unit, press the  key again to confirm.

- Frequency deviation \leq carrier frequency, if the frequency deviation is greater than the carrier frequency, the instrument will automatically limit the deviation value to the maximum value allowed by the current carrier frequency.
- The sum of the frequency deviation and the carrier frequency \leq the maximum frequency that the current carrier allows to set, if the frequency deviation is set to an invalid value, the instrument will automatically limit the deviation value to the maximum value allowed by the current carrier frequency.

UTG9000C-II User Manual

Comprehensive example

First make the instrument run in frequency modulation (FM) mode, and then set an internal pulse wave of 2kHz as the modulation signal and a sine wave with frequency of 10kHz and amplitude of 100mVpp as the carrier signal. Finally set the frequency deviation to be 5kHz. The specific steps are as follows:

1) Enable frequency modulation (FM) function

Press the **[Mode]** button, and move the cursor to FM by the **[▶]** key, press **[OK]** to enable FM.

2) Set modulation signal parameters and waveform

Follow step 1), press the **[OK]** key and use the numeric keypad to enter 2, then select the parameter unit and press the **[UNIT]** button.



Picture 4-12 Set FM modulation frequency and waveform

3) Set carrier waveform and parameters

Press the **[STD/MOD]** soft key, the STD is selected, then press **[SINE]** (default is sine wave) to select the sine wave as the carrier wave.



Picture 4-13 Set FM carrier waveform

Press **[Freq]** to set the frequency, use the numeric keypad to enter 10, then select the parameter unit.

Press **[Ampl]** to set the amplitude, use the numeric keypad to enter 100, then select the parameter unit.



Picture 4-14 Set FM frequency deviation

5) Enable channel output

Short press the **[Output]** button, if the backlight is on, it indicates the channel output is enabled.

The FM modulation waveform is shown below:

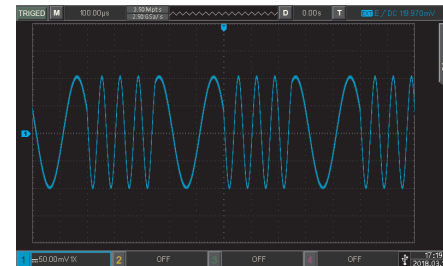

Picture 4-15 FM output waveform

4.2 Output Frequency Sweep Waveform

In the frequency sweep mode, the instrument outputs the waveform in linear or logarithmic way within the specified frequency sweep time. The trigger source can be internal or external trigger. All of sine waves, pulse waves, ramp waves, and arbitrary waves (except DC) can generate the frequency sweep output.

4.2.1 Select Frequency Sweep

1) Start frequency sweep

Press **[Mode]** and use the **▶** key to move the cursor to Log (or Line), then press **[OK]** to enable the frequency sweep. The instrument will output the frequency sweep waveform according to the current settings. The output logarithmic frequency sweep settings are shown below:



Picture 4-16 Set logarithmic frequency sweep

2) Select frequency sweep waveform

The frequency sweep waveform can be: sine wave, pulse wave, ramp wave or arbitrary wave, the default is sine wave. After selecting the frequency sweep waveform, press the **[STD/MOD]** button and STD is selected.



Picture 4-17 Set frequency sweep waveform

Select the frequency sweep waveform by pressing the waveform selection button:

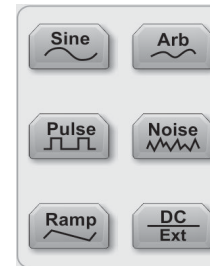

4.2.2 Set Start and Stop Frequency

Freq1 is the start frequency of the frequency sweep, and Freq2 is the stop frequency. The maximum frequency of Freq1 or Freq2 is the highest bandwidth frequency of the current carrier. When the Log or Line is enabled, and the MOD modulation is selected, press the **▼** button to move the cursor to Freq1 or Freq2, then press the **[OK]** button, enter the required value and select the unit, press **[OK]** again to confirm.

UTG9000C-II User Manual

- When start frequency < stop frequency, sweep from low frequency to high frequency.
- When start frequency > stop frequency, sweep from high frequency to low frequency.
- When start frequency = stop frequency, outputs fixed frequency.

By default, the start frequency is 1kHz and the stop frequency is 1MHz, but the range of start and stop frequency can vary with frequency sweep waveform. See table 4-3 below for the frequency range of each frequency sweep wave:

Table 4-3:

Carrier waveform	Frequency			
	UTG9002C-II		UTG9005C-II	
	Min	Max	Min	Max
Sine wave	1 μ Hz	2MHz	1 μ Hz	5MHz
Square wave	1 μ Hz	2MHz	1 μ Hz	5MHz
Ramp wave	1 μ Hz	200kHz	1 μ Hz	200kHz
Arbitrary wave	1 μ Hz	1MHz	1 μ Hz	1MHz

4.2.3 Frequency Sweep Mode

Press **[Mode]** and use the **[>]** key to move the cursor to Log (logarithmic frequency sweep) or Line (linear frequency sweep):

Linear frequency sweep: waveform generator changes output frequency in a linear way during frequency sweep;

Logarithmic frequency sweep: waveform generator changes output frequency in a logarithmic way.

4.2.4 Frequency Sweep Time

After the frequency sweep function is enabled, the default frequency sweep time (range of 1ms ~ 500s) is 1s. To change it, when the MOD modulation is selected, press **[<]** to move the cursor to Time and press **[OK]**, then enter the required value and select the unit, press **[OK]** again to confirm.



Picture 4-18 Set frequency sweep time

4.2.5 Select Trigger Source

The signal generator generates a frequency sweep output upon receiving a trigger signal and then waits for the next trigger signal. The trigger source of frequency sweep can be internal or external, which can be switched by pressing the **[TRIG]** key when MOD modulation is selected.

- 1) Internal trigger: waveform generator will output a continuous frequency sweep, the rate of which is determined by frequency sweep time.
- 2) External trigger: waveform generator is triggered by the TTL level signal input from the external modulation interface.

4.2.6 Comprehensive Example

First make the instrument run in frequency sweep mode, and then set a pulse wave signal with amplitude of 1Vpp and duty ratio of 50% as frequency sweep wave. The frequency sweep mode is linear. Set starting frequency to be 1kHz, stop frequency to be 50kHz, frequency sweep time to be 2ms, and use the internal source to trigger and output the frequency sweep wave. The specific steps are as follows:

1) Enable linear frequency sweep function

Press **[Mode]** and use the **▶** key to move the cursor to Line, then press **[OK]** to enable the linear frequency sweep.



Picture 4-19 Set linear frequency sweep

2) Select frequency sweep waveform

Press **[STD/MOD]** and STD is selected, then press **[Pulse]** (the default is sine wave) to select the pulse wave as the frequency sweep waveform.



Picture 4-20 Set frequency sweep waveform

Press the **[Ampl]** key, and use the numeric keypad to enter 1, then select the parameter unit **[mVpp]**.

Press the **[Duty]** key to set the duty ratio, use the numeric keypad to enter 50, then select the parameter unit **[50%]** (the default duty ratio is 50%).

3) Set start/stop frequency, frequency sweep time

Press the **[STD/MOD]** key and MOD is selected, then set the start/stop frequency, frequency sweep time:

Press **▼** to move the cursor to Freq1 (start frequency) and press **[OK]**, then use the numeric keypad to enter 1, and select the parameter unit **[kHz]**. The default start frequency is 1kHz.

Press **▼** to move the cursor to Freq2 (stop frequency) and press **[OK]**, then use the numeric keypad to enter 50, and select the parameter unit **[kHz]**. Press **▼** to move the cursor to Time (frequency sweep time) and press **[OK]**, then use the numeric keypad to enter 2, and select the parameter unit **[ms]**.



Picture 4-21 Set frequency sweep time

4) Enable channel output

Short press the **[Output]** button, if the backlight is on, it indicates the channel output is enabled.

The linear frequency sweep waveform is shown below:

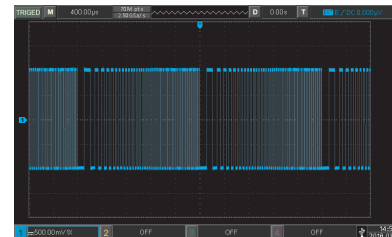

Picture 4-22 Frequency sweep output waveform

4.3 Output Arbitrary Wave

UTG9000C-II stores 20 types of arbitrary waveforms. See Table 4-4 (list of built-in arbitrary waves) for the name of each waveform.

4.3.1 Enable Arbitrary Wave Function

Press the  key to enable the arbitrary wave function, the instrument will output the arbitrary waveform with the current settings.



Picture 4-23 Arbitrary wave output



4.3.2 Select Arbitrary Wave

Select the built-in arbitrary waveform by pressing  or .

Table 4-4 List of built-in arbitrary waves

Arb0	Up_tri	Arb10	Lorentz
Arb1	log	Arb11	Sinc
Arb2	AbsSine	Arb12	SineVer
Arb3	AmpALT	Arb13	StairUD
Arb4	AttALT	Arb14	Trapezia
Arb5	EEG_A	Arb15	Pulseiogram
Arb6	Cardiac	Arb16	VOICE
Arb7	GaussianMonopulse	Arb17	StepResp
Arb8	GaussPulse	Arb18	TV
Arb9	LogNormal	Arb19	Radar

4.4 Power Amplifier Output

The built-in power amplifier has a full power bandwidth of up to 200kHz, a maximum output power of 4W, and an output slew rate greater than 18V/μs. Long press  (about 3s),  LED breathing indicates that the power amplifier has an output, and the output interface is located at the rear panel BNC (UTG9002C-II does not have this function and interface).

Chapter 5 Fault Handling

Possible faults in use of device and troubleshooting methods are listed below, please handle them according to corresponding steps. If they cannot be handled, please contact with the dealer or local office, and provide the machine information (method: long press  for 3 seconds).

5.1 No Display on Screen (Blank Screen)

Press the power switch, if the signal generator still shows the blank screen:

- 1) Inspect whether power source is connected well.
- 2) Please restart the instrument.

5.2 No Waveform Output

Setting is correct but no waveform is outputted:

- 1) Inspect whether BNC cable and channel output terminal are connected correctly.
- 2) Check whether the  button is turn on.

Chapter 6 Service and Support

6.1 Warranty Overview

- UNI-T (UNI-TREND TECHNOLOGY (CHINA) CO., LTD.) guarantees that the products it produces and sells are free from any defects of material and process within 3 years from the date of shipment by the authorized dealer. If the product is proven to be defective during warranty period, UNI-T will repair and replace according to the provisions of warranty.
- To arrange repair or ask for the whole warranty, please contact with the nearest sales or maintenance department of UNI-T.
- Except warranties provided in the outline or other applicable warranties, UNI-T does not provide any other express or implied warranties, including but not limited to any implied warranties about tradability and applicability to special purpose of the product. In any case, UNI-T assumes no responsibility for indirect, special or consequent loss.

6.2 Contact Us

- Please contact with local dealer or sales center of UNI-T for products.
- Service support, many products of UNI-T are equipped with plans for extending warranty period and calibration period. Please contact with local dealer or sales center of UNI-T.
- Please visit our website for more details : <http://www.uni-trend.com>

Appendix A: Factory Reset State

Parameter	Factory default
Channel parameter	
Current carrier wave	Sine wave
Output load	50Ω
Sync output	Off
Channel output	Off
Fundamental wave	
Frequency	1kHz
Amplitude	100mVpp
DC offset	0mV
Initial phase	0°
Pulse wave duty ratio	50%
Ramp duty	50%
Arbitrary wave	
Built-in arbitrary wave	Arb0

AM modulation	
Modulation source	Internal
Modulation wave	Sine wave
Modulation frequency	100Hz
Modulation depth	100%
FM modulation	
Modulation source	Internal
Modulation wave	Sine wave
Modulation frequency	100Hz
Frequency deviation	1kHz
Frequency sweep	
Start frequency	1kHz
Stop frequency	1MHz
Frequency sweep time	1s
Trigger source	Internal
System parameter	
Buzzer	On
Backlight	III

Appendix B: Performance Index

Model	UTG9002C-II	UTG9005C-II
Channel	Single	Single
Max. frequency	2MHz	5MHz
Sampling rate	125MSa/s	125MSa/s
Waveform	Sine wave,pulse wave,ramp wave,arbitrary wave,noise,DC	
Operating mode	Output gating,continuous,modulation,frequency sweep	
Modulation type	AM, FM	

Waveform characteristics

Sine wave		
Frequency range	1μHz ~ 2MHz	1μHz ~ 5MHz
Resolution	1μHz	
Accuracy	±50ppm in 90 days, ±100ppm in one year (18°C to 28°C)	
Harmonic distortion (typical)	Test condition: output power 0dBm	
	DC ~ 20kHz	-55dBc
	20kHz ~ 1MHz	-50dBc
	1MHz ~ 5MHz	-40dBc
Total harmonic distortion (typical)	DC ~ 20kHz, 1Vpp <0.2%	
Pulse wave		
Frequency range	1μHz ~ 2MHz	1μHz ~ 5MHz
Resolution	1μHz	

Rise/fall time	< 50ns (typical value, 1kHz, 1Vpp)	
Overshoot (typical)	< 2%	
Duty ratio	0.01% ~ 99.99%	
Min pulse width	≥80ns	
Jitter (typical)	1ns + 100ppm of period	
Ramp wave		
Frequency range	1μHz ~ 200kHz	
Resolution	1μHz	
Non-linearity	3% 2 mV (typical value, 1kHz, 1Vpp, duty of 50%)	
Duty	0.0% to 100.0%	
Min. edge time	≥35ns	
DC offset		
Range (peak AC+DC)	5V (50Ω)	
	10V (high resistance)	
Offset accuracy	(1% of offset setting + 0.5% of amplitude + 2mV)	
Arbitrary wave characteristics		
Frequency range	1μHz ~ 1MHz	1μHz ~ 1MHz
Resolution	1μHz	
Vertical resolution	14bits (including symbols)	
Sampling rate	125MSa/s	
Non-volatile storage	Built-in 20 sets of waveforms	

UTG9000C-II User Manual

Output characteristics		
Amplitude range	50Ω: 1mVpp ~ 10Vpp	50Ω: 1mVpp ~ 10Vpp
	High resistance: 2mVpp~20Vpp	High resistance: 2mVpp ~ 20Vpp
Accuracy (1kHz sine wave)	3% of the amplitude set value 2 mV	
Amplitude flatness (relative to 1kHz sine wave, 1Vpp/50Ω)	< 100kHz 0.1dB	
Waveform output		
Impedance	50Ω typical value	
Protection	Overvoltage protection	
Power amplifier output (only available to UTG9005C-II)		
Sine output power RMS (RL=7.5Ω)	Max 4W (typical value, output sine wave, 100kHz)	
Output voltage	Sine wave, triangle wave: ≤100KHz 23Vpp ≤200KHz 15Vpp	
	Square wave: ≤50KHz 23Vpp ≤200KHz 15Vpp	
Output current	0.75Arms (output sine wave, 100kHz, RL=7.5Ω)	
Output impedance	< 2Ω	
Full power bandwidth	200kHz	

Output slew rate	18V/us
Overshoot	5% (output square wave, 1kHz, 1Vpp, RL=7.5Ω)

Modulation type

AM modulation		
Carrier wave	Sine, pulse, ramp, arbitrary wave	
Source	Internal / external	
Modulation wave	Sine wave, pulse wave, noise, arbitrary wave	
Modulation frequency	2mHz ~ 50kHz	
Modulation depth	0% ~ 120%	
FM modulation		
Carrier wave	Sine, pulse, ramp, arbitrary wave	
Source	Internal / external	
Modulation wave	Sine wave, pulse wave, noise, arbitrary wave	
Modulation frequency	2mHz ~ 50kHz	
Frequency deviation	1μHz ~ 1MHz	1μHz ~ 2.5MHz
Frequency sweep		
Carrier wave	Sine, pulse, ramp, arbitrary wave	
Type	Linear, logarithmic	
Frequency sweep time	1ms ~ 500s 0.1%	
Trigger source	Internal / external	

Synchronization signal		
Output level	TTL compatible	
Output frequency	1μHz ~ 1MHz	1μHz ~ 1MHz
Output impedance	50Ω, typical value	
Coupled mode	DC	
Front panel connector		
Modulation input	5Vpk full scale	
	< 10kΩinput impedance	
Trigger output	TTL compatible	
Count input	TTL compatible	
Count		
Input level	TTL compatible	
Input frequency range	100mHz ~ 100MHz	
Frequency resolution	6 bits/s	
Coupled mode	DC	

General specifications

Display	
Display type	EBTN LCD
Power source	
Supply voltage	100 - 240 VAC, 45 - 440Hz, CAT 0
Power consumption	35VA Max
Fuse	2A, level T, 250V

Environment	
Temperature range	Operating: 10°C ~ +40°C
	Non-operating: -20°C ~ +60°C
Humidity range	Below +35°C: ≤90% RH
	+35°C ~ +40°C: ≤60% RH
Altitude	Operating: below 2,000m
	Non-operating: below 15,000m
Mechanical specification	
Dimension (reference)	265mm×110mm×320mm
Net weight	2.8kg
Gross weight	3.1kg

Appendix C: List of Accessories

Model	UTG9000C-II
Standard configuration	A power cord that meets the country's standard
	One BNC+red and black alligator clip connection
	A USB data cable
	A CD for users

Appendix D: Maintenance and Cleaning

General maintenance

- Please don't store or place the instrument where LCD is exposed to direct sunlight for a long time.
- To avoid damage to the instrument or connecting line, please don't place it in the mist, liquid or solvent.

Cleaning

- Please clean the instrument frequently in the light of use.
- Disconnect the power, and then clean with soft cloth that is wet but not dripping (wipe floating dust off the exterior of instrument with mild detergent or clear water, don't use chemical medicine or detergent containing benzene, methylbenzene, dimethylbenzene, acetone and other potent substances).
- Please take care not to scratch the LCD screen when cleaning the instrument.
- Please protect the instrument against any corrosive liquid to prevent damage.

Warning: please confirm that the instrument is completely dry before powering on to prevent electrical short circuit and even personal injury due to moisture.

UNI-T®

UNI-TREND TECHNOLOGY (CHINA) CO., LTD.

No6, Gong Ye Bei 1st Road,
Songshan Lake National High-Tech Industrial
Development Zone, Dongguan City,
Guangdong Province, China
Tel: (86-769) 8572 3888
<http://www.uni-trend.com>