

LMZ21701 1 A SIMPLE SWITCHER® Nano Module with 17 V Maximum Input Voltage

1 Features

- Integrated Inductor
- Miniature 3.5 mm x 3.5 mm x 1.75 mm Package
- [35 mm² Solution Size \(Single Sided\)](#)
- -40 °C to 125 °C Junction Temperature Range
- Adjustable Output Voltage
- Integrated Compensation
- Adjustable Soft Start Function
- Starts into Pre-Biased Loads
- Power Good and Enable Pins
- Seamless Transition to Power-Save Mode
- Up to 1000 mA Output Current
- Input Voltage Range 3 V to 17 V
- Output Voltage Range 0.9 V to 6 V
- Efficiency up to 95 %
- 1.5 μ A Shutdown Current
- 17 μ A Quiescent Current

2 Applications

- Point of Load Conversions from 3.3 V, 5 V, or 12 V Input Voltage
- Space Constrained Applications
- LDO Replacement

3 Description

The LMZ21701 SIMPLE SWITCHER® Nano Module is an easy-to-use step-down DC-DC solution capable of driving up to 1000 mA load in space-constrained applications. Only an input capacitor, an output capacitor, a softstart capacitor, and two resistors are required for basic operation.

Quick links to typical applications: [V_{OUT} = 1.2 V](#), [V_{OUT} = 1.8 V](#), [V_{OUT} = 2.5 V](#), [V_{OUT} = 3.3 V](#), [V_{OUT} = 5.0 V](#)

Device Information⁽¹⁾

PART NUMBER	PACKAGE	BODY SIZE (NOM)
LMZ21701SILT	SIL0008E	3.5 mm x 3.5 mm

(1) For all available packages, see the orderable addendum at the end of the datasheet.

4 Simplified Schematic

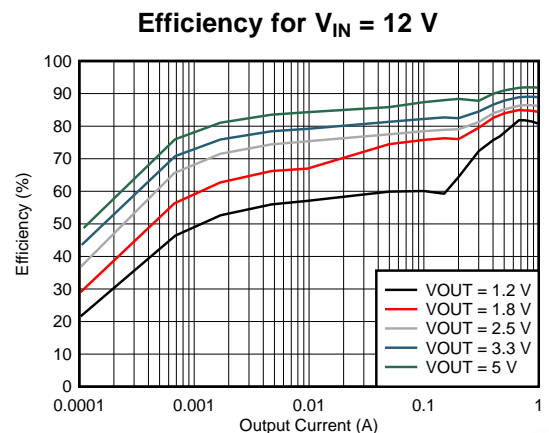
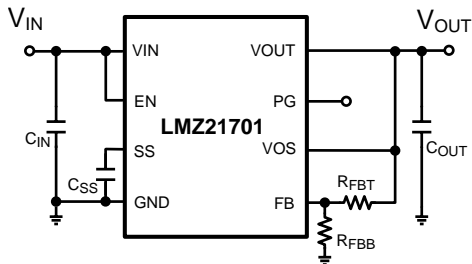

Table of Contents

1 Features	1	8.5 Device Functional Modes.....	11
2 Applications	1	9 Application and Implementation	11
3 Description	1	9.1 Application Information.....	11
4 Simplified Schematic	1	9.2 Typical Application	11
5 Revision History	2	9.3 Do's and Don'ts	24
6 Pin Configuration and Functions	3	10 Power Supply Recommendations	24
7 Specifications	4	10.1 Voltage Range	24
7.1 Absolute Maximum Ratings	4	10.2 Current Capability	24
7.2 Handling Ratings.....	4	10.3 Input Connection	24
7.3 Recommended Operating Conditions.....	4	11 Layout	25
7.4 Thermal Information	4	11.1 Layout Guidelines	25
7.5 Electrical Characteristics.....	5	11.2 Layout Example	26
7.6 Typical Characteristics.....	6	12 Device and Documentation Support	29
8 Detailed Description	8	12.1 Device Support	29
8.1 Overview	8	12.2 Trademarks	29
8.2 Functional Block Diagram	8	12.3 Electrostatic Discharge Caution.....	29
8.3 Package Construction	9	12.4 Glossary	29
8.4 Feature Description.....	10	13 Mechanical, Packaging, and Orderable Information	29

5 Revision History

NOTE: Page numbers for previous revisions may differ from page numbers in the current version.

Changes from Revision C (October 2014) to Revision D	Page
• Changed from product Preview to Production Data	1
• Changed to Final Limits	5
<hr/>	
Changes from Revision B (August 2014) to Revision C	Page
• Added <i>Device Information and Handling Rating tables, Feature Description, Application and Implementation Layout Device and Documentation Support and Mechanical, Packaging, and Orderable Information, moved some curves to Application Curves</i>	1
<hr/>	
Changes from Revision A (October 2013) to Revision B	Page
• Updated datasheet to new TI standards	1
<hr/>	
Changes from Original (August 2012) to Revision A	Page
• Changed Description	1

6 Pin Configuration and Functions

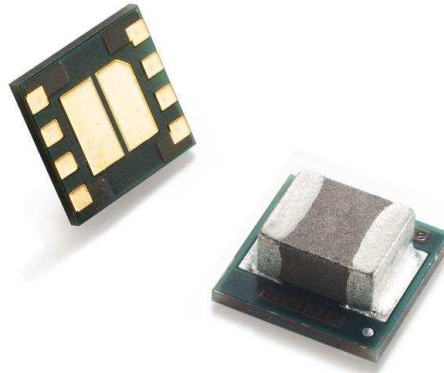

Figure 1. LMZ21701 in the SIL0008E Package

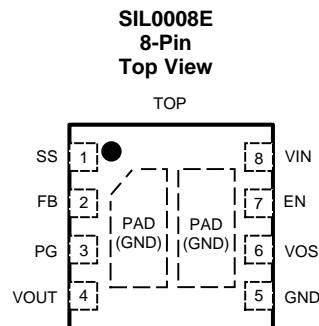

Table 1. Pin Functions

PIN		I/O	DESCRIPTION
NAME	NO.		
SS	1	I	Soft-start pin. An external capacitor connected to this pin sets the internal voltage reference ramp time. It can be used for tracking and sequencing.
FB	2	I	Voltage feedback. Connect resistive voltage divider to this pin to set the output voltage.
PG	3	O	Output power good (High = VOUT ready, Low = VOUT below nominal regulation); open drain (requires pull-up resistor; goes low impedance when EN is low).
VOUT	4	O	Output Voltage. Connected to one terminal of the integrated inductor. Connect output filter capacitor between VOUT and PGND.
GND	5	I	Ground for the power MOSFETs and gate-drive circuitry.
VOS	6	I	Output voltage sense pin and connection for the control loop circuitry.
EN	7	I	Enable input (High = enabled, Low = disabled). Internal pull down resistor keeps logic level low if pin is left floating.
VIN	8	I	Supply voltage for control circuitry and power stage.
PAD			Electrically connected to GND. Must be soldered to a ground copper plane to achieve appropriate power dissipation and mechanical reliability.

7 Specifications

7.1 Absolute Maximum Ratings

Over operating free-air temperature range (unless otherwise noted)⁽¹⁾⁽²⁾

	MIN	MAX	UNIT
V _{IN}	-0.3	20	V
EN, SS	-0.3	V _{IN} +0.3 V w/ 20 V max	V
FB, PG, VOS	-0.3	7	V
PG sink current		10	mA
Junction Temperature (T _{J-MAX})	-40	125	°C
Maximum Lead Temperature		260	°C

- (1) Stresses beyond those listed under *Absolute Maximum Ratings* may cause permanent damage to the device. These are stress ratings only, which do not imply functional operation of the device at these or any other conditions beyond those indicated under *Recommended Operating Conditions*. Exposure to absolute-maximum-rated conditions for extended periods may affect device reliability.
- (2) If Military/Aerospace specified devices are required, please contact the Texas Instruments Sales Office/ Distributors for availability and specifications.

7.2 Handling Ratings

		MIN	MAX	UNIT	
T _{stg}	Storage temperature range	-65	150	°C	
V _(ESD)	Electrostatic discharge	Human body model (HBM), per ANSI/ESDA/JEDEC JS-001, all pins ⁽¹⁾	-2000	2000	V
		Charged device model (CDM), per JEDEC specification JESD22-C101, all pins ⁽²⁾	-500	500	

- (1) JEDEC document JEP155 states that 500-V HBM allows safe manufacturing with a standard ESD control process.
- (2) JEDEC document JEP157 states that 250-V CDM allows safe manufacturing with a standard ESD control process.

7.3 Recommended Operating Conditions⁽¹⁾

Over operating free-air temperature range (unless otherwise noted)

	MIN	MAX	UNIT
Input Voltage Range	3	17	V
Output Voltage Range	0.9	6.0	V
Recommended Load Current	0	1000	mA
Junction Temperature (T _J) Range	-40	125	°C

- (1) Operating Ratings indicate conditions for which the device is intended to be functional, but do not guarantee specific performance limits. For guaranteed specifications, see the [Electrical Characteristics](#) section.

7.4 Thermal Information

THERMAL METRIC ⁽¹⁾		LMZ21701	UNIT
		SIL0008E	
		8 PINS	
R _{θJA}	Junction-to-ambient thermal resistance ⁽²⁾	42.6	°C/W
R _{θJC(top)}	Junction-to-case (top) thermal resistance	20.8	
R _{θJB}	Junction-to-board thermal resistance	9.4	
ψ _{JT}	Junction-to-top characterization parameter	1.5	
ψ _{JB}	Junction-to-board characterization parameter	9.3	
R _{θJC(bot)}	Junction-to-case (bottom) thermal resistance	1.8	

- (1) For more information about traditional and new thermal metrics, see the *IC Package Thermal Metrics* application report, [SPRA953](#).
- (2) Junction-to-ambient thermal resistance (θ_{JA}) is based on 4 layer board thermal measurements, performed under the conditions and guidelines set forth in the JEDEC standards JESD51-1 to JESD51-11. θ_{JA} varies with PCB copper area, power dissipation, and airflow.

7.5 Electrical Characteristics⁽¹⁾

Limits apply over the recommended operating junction temperature (T_J) range of $-40\text{ }^\circ\text{C}$ to $+125\text{ }^\circ\text{C}$, unless otherwise stated. Minimum and Maximum limits are specified through test, design or statistical correlation. Typical values represent the most likely parametric norm at $T_J = 25\text{ }^\circ\text{C}$, and are provided for reference purposes only. Unless otherwise stated the following conditions apply: $V_{IN} = 12\text{ V}$.

PARAMETER	TEST CONDITIONS	MIN ⁽¹⁾	TYP ⁽²⁾	MAX ⁽¹⁾	UNIT	
SYSTEM PARAMETERS						
I_Q	Operating quiescent current	EN = high, $I_{OUT} = 0\text{ mA}$, $T_J = -40\text{ }^\circ\text{C}$ to $85\text{ }^\circ\text{C}$ device not switching	17	25	μA	
		EN = high, $I_{OUT} = 0\text{ mA}$, $T_J = -40\text{ }^\circ\text{C}$ to $125\text{ }^\circ\text{C}$ device not switching	17	28	μA	
I_{SD}	Shutdown current	EN = low, $T_J = -40\text{ }^\circ\text{C}$ to $85\text{ }^\circ\text{C}$	1.5	4	μA	
		EN = low, $T_J = -40\text{ }^\circ\text{C}$ to $125\text{ }^\circ\text{C}$	1.5	5	μA	
V_{INUVLO}	Input under voltage lock out rising threshold	2.8	2.9	3	V	
$V_{INUVLO-HYS}$	Input under voltage lock out hysteresis	0.125	0.180	0.260	V	
T_{SD}	Thermal shutdown	Rising Threshold		160	$^\circ\text{C}$	
$T_{SD-HYST}$	Thermal shutdown hysteresis			30	$^\circ\text{C}$	
CONTROL						
$V_{IH, ENABLE}$	Enable logic HIGH voltage			0.9	V	
$V_{IL, ENABLE}$	Enable logic LOW voltage			0.3	V	
I_{LKG}	Input leakage current	EN = V_{IN} or GND	0.01	1	μA	
V_{TH_PG}	Power Good threshold voltage	Rising (% V_{OUT})	92 %	95 %	98 %	
		Falling (% V_{OUT})	87 %	90 %	93 %	
V_{OL_PG}	Power Good output low voltage	$I_{PG} = -2\text{ mA}$	0.07	0.3	V	
I_{LKG_PG}	Power Good leakage current	$V_{PG} = 1.8\text{ V}$	1	400	nA	
I_{SS}	Softstart Pin source current		2.5	2.84	3.2	μA
POWER STAGE						
$R_{DS(ON)}$	High-Side MOSFET ON Resistance	$V_{IN} \geq 6\text{ V}$	82		m Ω	
		$V_{IN} = 3\text{ V}$	120			
	Low-Side MOSFET ON Resistance	$V_{IN} \geq 6\text{ V}$	40		m Ω	
		$V_{IN} = 3\text{ V}$	50			
L	Integrated power inductor value		2.2		μH	
DCR	Integrated power inductor DC resistance		92		m Ω	
I_{CL-HS}	High-Side MOSFET Current Limit	$T_A = 25\text{ }^\circ\text{C}$	1.4	1.8	2.2	A
I_{CL-LS}	Low-Side MOSFET Current Limit	$T_A = 25\text{ }^\circ\text{C}$		1.2		A
I_{CL-DC}	Output (DC) current limit	$V_{OUT} = 5.0\text{ V}$, $T_A = 85\text{ }^\circ\text{C}$		1.3		A
OUTPUT						
V_{REF}	Internal reference voltage		0.7869	0.803	0.8191	V
I_{FB}	Feedback pin leakage current	$V_{FB} = 0.8\text{ V}$		1	100	nA
V_{OUT}	Light load initial voltage accuracy	Power save mode, $C_{OUT} = 22\text{ }\mu\text{F}$, $T_A = -40\text{ }^\circ\text{C}$ to $85\text{ }^\circ\text{C}$, 1% FB Resistors	-2.3 %		2.8 %	
V_{OUT}	Load regulation	$V_{OUT} = 3.3\text{ V}$ PWM mode operation		0.05 %		/ A
V_{OUT}	Line regulation	$3\text{ V} \leq V_{IN} \leq 17\text{ V}$, $V_{OUT} = 3.3\text{ V}$, $I_{OUT} = 1000\text{ mA}$ PWM mode operation		0.02 %		/ V

(1) Min and Max limits are 100% production tested at $25\text{ }^\circ\text{C}$. Limits over the operating temperature range are guaranteed through correlation using Statistical Quality Control (SQC) methods. Limits are used to calculate National's Average Outgoing Quality Level (AOQL).

(2) Typical numbers are at $25\text{ }^\circ\text{C}$ and represent the most likely parametric norm.

Electrical Characteristics⁽¹⁾ (continued)

Limits apply over the recommended operating junction temperature (T_J) range of $-40\text{ }^\circ\text{C}$ to $+125\text{ }^\circ\text{C}$, unless otherwise stated. Minimum and Maximum limits are specified through test, design or statistical correlation. Typical values represent the most likely parametric norm at $T_J = 25\text{ }^\circ\text{C}$, and are provided for reference purposes only. Unless otherwise stated the following conditions apply: $V_{IN} = 12\text{ V}$.

	PARAMETER	TEST CONDITIONS	MIN ⁽¹⁾	TYP ⁽²⁾	MAX ⁽¹⁾	UNIT
SYSTEM CHARACTERISTICS						
η	Full Load Efficiency	$V_{OUT} = 3.3\text{ V}$, $I_{OUT} = 1000\text{ mA}$		93 %		
	Light Load Efficiency	$V_{OUT} = 3.3\text{ V}$, $I_{OUT} = 1\text{ mA}$		72 %		

7.6 Typical Characteristics

Unless otherwise specified the following conditions apply: $V_{IN} = 12\text{ V}$, $T_A = 25\text{ }^\circ\text{C}$

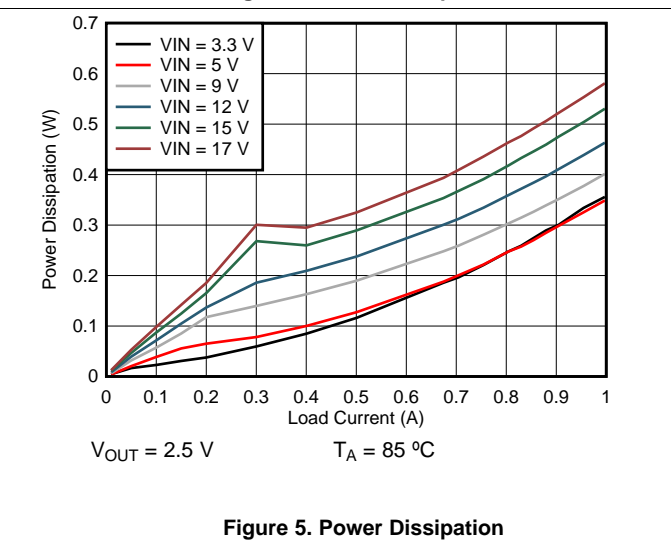
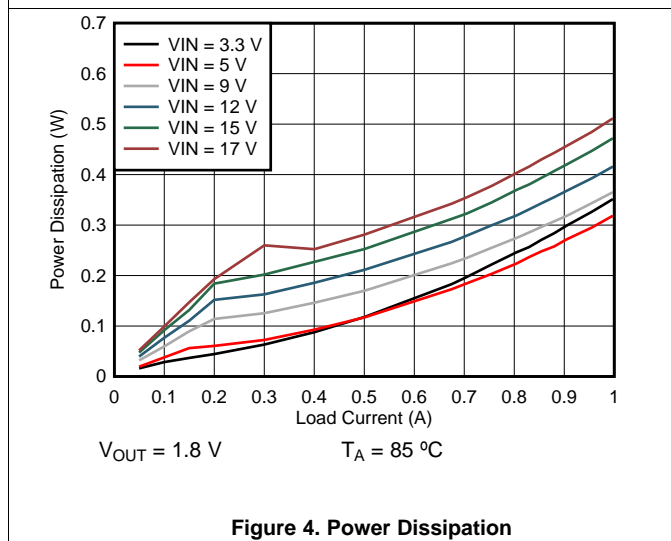
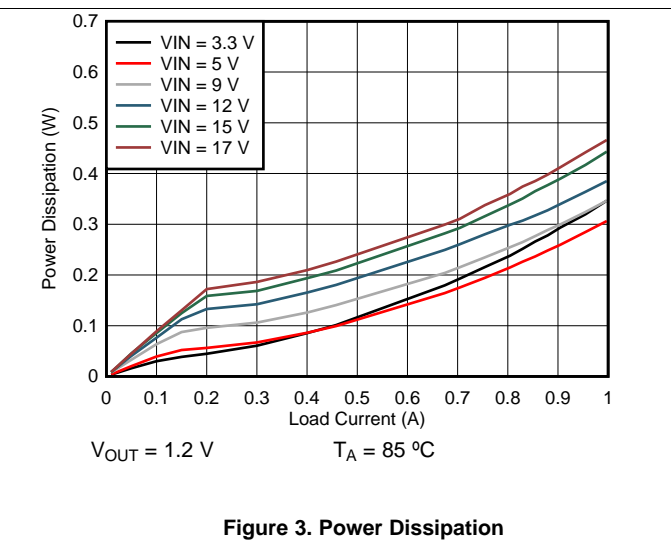
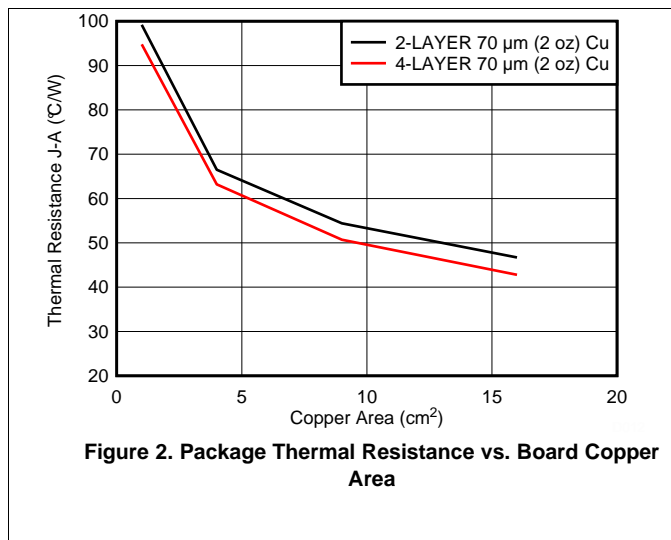

Typical Characteristics (continued)

Unless otherwise specified the following conditions apply: $V_{IN} = 12\text{ V}$, $T_A = 25\text{ }^\circ\text{C}$

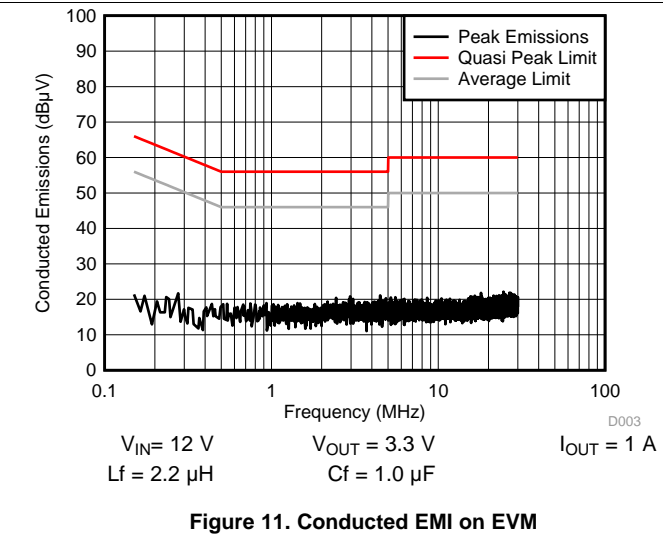
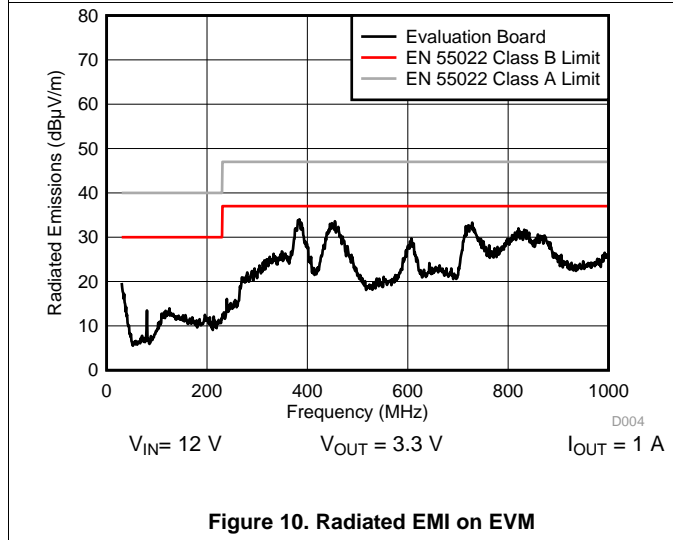
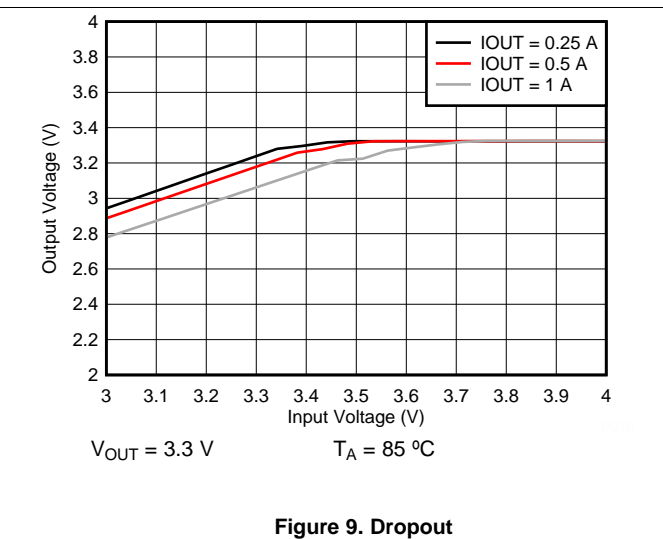
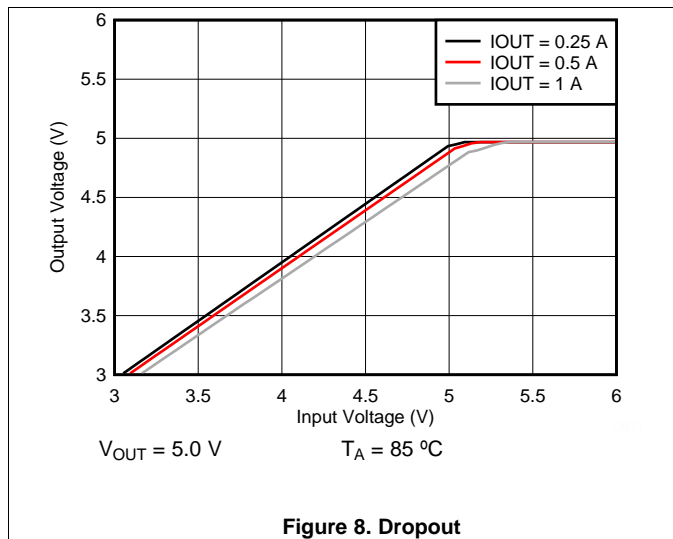
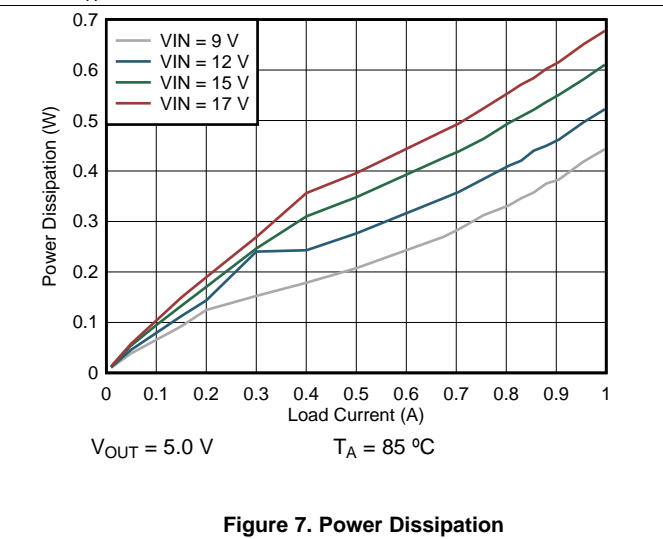
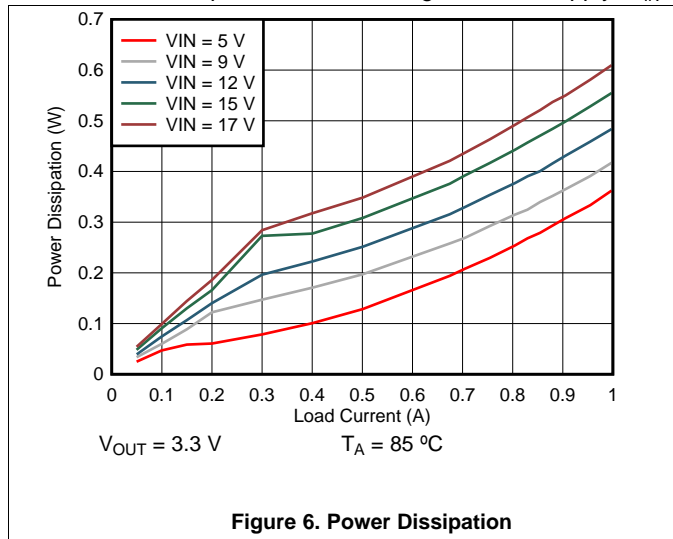

8 Detailed Description

8.1 Overview

The LMZ21701 SIMPLE SWITCHER® Nano Module is an easy-to-use step-down DC-DC solution capable of driving up to 1000 mA load in space-constrained applications. Only an input capacitor, an output capacitor, a softstart capacitor, and two resistors are required for basic operation. The Nano Module comes in 8-pin DFN footprint package with an integrated inductor. The LMZ21701 architecture is based on DCS-Control™ (Direct Control with Seamless Transition into Power Save Mode). This architecture combines the fast transient response and stability of hysteretic type converters along with the accurate DC output regulation of voltage mode and current mode regulators.

The LMZ21701 architecture uses Pulse Width Modulation (PWM) mode for medium and heavy load requirements and Power Save Mode (PSM) at light loads for high efficiency. In PWM mode the switching frequency is controlled over the input voltage range. The value depends on the output voltage setting and is typically reduced at low output voltages to achieve higher efficiency. In PSM the switching frequency decreases linearly with the load current. Since the architecture of the device supports both operation modes (PWM and PSM) in a single circuit building block, the transition between the modes of operation is seamless with minimal effect on the output voltage.

8.2 Functional Block Diagram

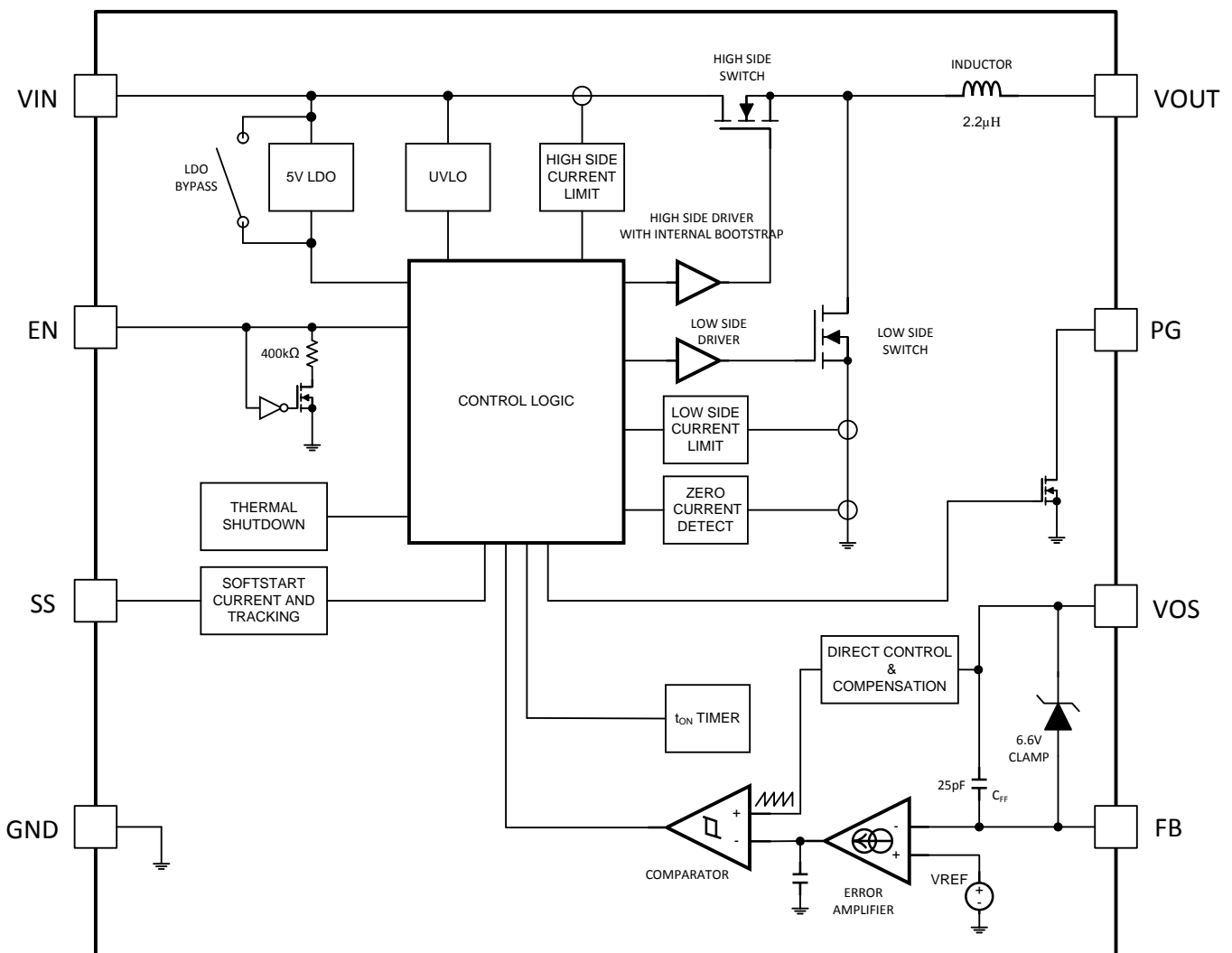

8.3 Package Construction

In order to achieve a small solution size the LMZ21701 Nano Module comes in an innovative MicroSiP™ package. The construction consists of a synchronous buck converter IC embedded inside an FR-4 laminate substrate, with a power inductor mounted on top of the substrate material. See [Figure 12](#) and [Figure 13](#) below. The bottom (landing pads) of the package resemble a typical 8-pin DFN package. See the Mechanical drawings at the end of the datasheet for details on the recommended landing pattern and solder paste stencil information.

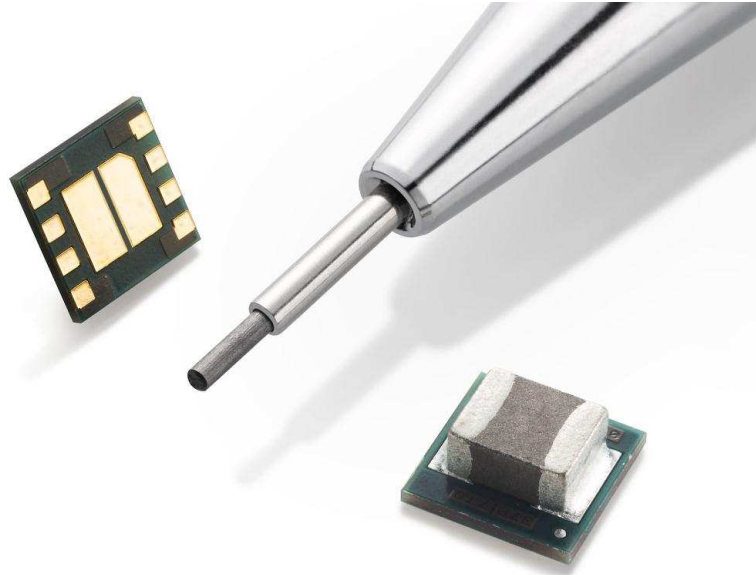

Figure 12. LMZ21701 in the SIL0008E Package

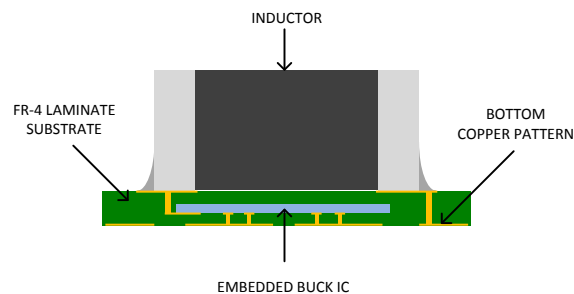

Figure 13. LMZ21701 Package Construction Cross Section (Illustration Only, Not to Scale)

8.4 Feature Description

8.4.1 Input Under Voltage Lockout

The LMZ21701 features input under voltage lockout (UVLO) circuit. It monitors the input voltage level and prevents the device from switching the power MOSFETs if V_{IN} is not high enough. The typical V_{IN} UVLO rising threshold is 2.9 V with 180 mV of hysteresis.

8.4.2 Enable Input (EN)

The enable pin (EN) is weakly pulled down internally through a 400 k Ω resistor to keep EN logic low when the pin is floating. The pull-down resistor is not connected when EN is set high. Once the voltage on the enable pin (EN) is set high the Nano Module will start operation. If EN is set low (< 0.3 V) the LMZ21701 will enter shutdown mode. The typical shutdown quiescent current is 1.5 μ A.

8.4.3 Softstart and Tracking Function (SS)

When EN is set high for device operation the LMZ21701 will start switching after 50 μ s delay and the output voltage will start rising. The V_{OUT} rising slope is controlled by the external capacitor C_{SS} connected to the softstart (SS) pin. The Nano Module has a 2.9 μ A constant current source internally connected to the SS pin to program the softstart time T_{SS} :

$$T_{SS} = C_{SS} \times 1.25 \text{ V} / 2.9 \mu\text{A} \quad (1)$$

The softstart capacitor voltage is reset to zero volts when EN is pulled low and when the thermal protection is active.

If tracking function is desired, the SS pin can be used to track external voltage. If the applied external tracking voltage is between 100 mV and 1.2 V, the FB voltage will follow SS according to the following relationship:

$$V_{FB} = 0.64 \times V_{SS} \quad (2)$$

8.4.4 Power Good Function (PG)

The LMZ21701 features a power good function which can be used for sequencing of multiple rails. The PG pin is an open-drain output and requires a pull-up resistor R_{PG} to V_{OUT} (or any other external voltage less than 7 V). When the Nano Module is enabled and UVLO is satisfied, the power good function starts monitoring the output voltage. The PG pin is kept at logic low if the output has not reached the proper regulation voltage. Refer to the [Electrical Characteristics](#) table for the PG voltage thresholds. The PG pin can sink 2 mA of current which sets the minimum limit of the R_{PG} resistance value:

$$R_{PG-MIN} = V_{PULL-UP} / 2 \text{ mA} \quad (3)$$

The PG pin goes low impedance if the device is disabled or the thermal protection is active.

8.4.5 Output Voltage Setting

The output voltage of the LMZ21701 is set by a resistive divider from V_{OUT} to GND, connected to the feedback (FB) pin. The output voltage can be set between 0.9 V and 6 V. The voltage at the FB pin is regulated to 0.8 V. The recommended minimum divider current is 2 μ A. This sets a maximum limit on the bottom feedback resistor R_{FBB} . Its value should not exceed 400 k Ω . The top feedback resistor R_{FBT} can be calculated using the following formula:

$$R_{FBT} = R_{FBB} \times (V_{OUT} / 0.8 - 1) \quad (4)$$

8.4.6 Output Current Limit and Output Short Circuit Protection

The LMZ21701 has integrated protection against heavy loads and output short circuit events. Both, the high-side FET and low-side FET have current monitoring circuitry. If the current limit threshold of the high-side FET is reached, the high-side FET will be turned off and the low-side FET will be turned on to ramp down the inductor current. Once the current through the low-side FET has decreased below a safe level, the high-side device will be allowed to turn on again. The actual DC output current depends on the input voltage, output voltage, and switching frequency. Refer to the [Application Curves](#) section for more information.

Feature Description (continued)

8.4.7 Thermal Protection

The nano module monitors its junction temperature (T_j) and shuts itself off if the it gets too hot. The thermal shutdown threshold for the junction is typically 160 °C. Both, high-side and low-side FETs are turned off until the junction temperature has decreased under the hysteresis level, typically 30 °C below the shutdown temperature.

8.5 Device Functional Modes

8.5.1 PWM Mode Operation

The LMZ21701 operates in PWM mode when the output current is greater than half the inductor ripple current. The frequency variation in PWM mode is controlled and depends on the V_{IN} and V_{OUT} settings. Refer to the [Application Curves](#) section for switching frequency graphs for several typical output voltage settings. As the load current is decreased and the valley of the inductor current ripple reaches 0 A the device enters PSM operation to maintain high efficiency.

8.5.2 PSM Operation

Once the load current decreases and the valley of the inductor current reaches 0 A, the LMZ21701 will transition to Power Save Mode of operation. The device will remain in PSM as long as the inductor current is discontinuous. The switching frequency will decrease linearly with the load current. If V_{IN} decreases to about 15 % above V_{OUT} the device will not enter PSM and will maintain output regulation in PWM mode.

9 Application and Implementation

NOTE

Information in the following applications sections is not part of the TI component specification, and TI does not warrant its accuracy or completeness. TI's customers are responsible for determining suitability of components for their purposes. Customers should validate and test their design implementation to confirm system functionality.

9.1 Application Information

The LMZ21701 is a step down DC-to-DC converter. It is used to convert higher DC voltage to a regulated lower DC voltage with maximum load current of 1 A. The following design procedure can be used to select components for the LMZ21701. Alternatively, the WEBENCH[®] software can be used to select from a large database of components, run electrical simulations, and optimize the design for specific performance. Please go to webench.ti.com to access the WEBENCH[®] tool.

9.2 Typical Application

For a quick start, the following component values can be used as a design starting point for several typical output voltage rails and 1 A of output load current.

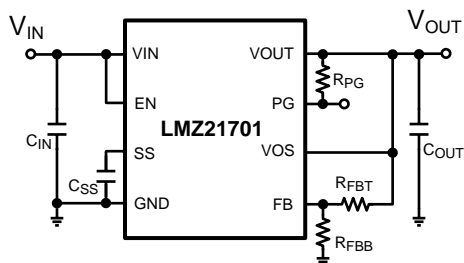

Figure 14. Typical Applications Circuit

COMPONENT VALUES FOR $V_{OUT}=1.2V$			
C_{IN}	22 μ F	$\geq 25V$	X7R or X5R
C_{OUT}	22 μ F	$\geq 10V$	X7R or X5R
C_{SS}	3300pF	$\geq 10V$	X7R or X5R
R_{FBT}	41.2k Ω	1%	
R_{FBB}	82.5k Ω	1%	
R_{PG}	10k Ω	1%	

Figure 15. External Component Values
($V_{OUT} = 1.2 V$)

Typical Application (continued)

COMPONENT VALUES FOR $V_{OUT}=1.8V$			
C_{IN}	22 μ F	$\geq 25V$	X7R or X5R
C_{OUT}	22 μ F	$\geq 10V$	X7R or X5R
C_{SS}	3300pF	$\geq 10V$	X7R or X5R
R_{FBT}	147k Ω	1%	
R_{FBB}	118k Ω	1%	
R_{PG}	10k Ω	1%	

**Figure 16. External Component Values
($V_{OUT} = 1.8 V$)**

COMPONENT VALUES FOR $V_{OUT}=2.5V$			
C_{IN}	22 μ F	$\geq 25V$	X7R or X5R
C_{OUT}	22 μ F	$\geq 10V$	X7R or X5R
C_{SS}	3300pF	$\geq 10V$	X7R or X5R
R_{FBT}	357k Ω	1%	
R_{FBB}	169k Ω	1%	
R_{PG}	10k Ω	1%	

**Figure 17. External Component Values
($V_{OUT} = 2.5 V$)**

COMPONENT VALUES FOR $V_{OUT}=3.3V$			
C_{IN}	22 μ F	$\geq 25V$	X7R or X5R
C_{OUT}	22 μ F	$\geq 10V$	X7R or X5R
C_{SS}	3300pF	$\geq 10V$	X7R or X5R
R_{FBT}	1.21M Ω	1%	
R_{FBB}	383k Ω	1%	
R_{PG}	10k Ω	1%	

**Figure 18. External Component Values
($V_{OUT} = 3.3 V$)**

COMPONENT VALUES FOR $V_{OUT}=5.0V$			
C_{IN}	22 μ F	$\geq 25V$	X7R or X5R
C_{OUT}	22 μ F	$\geq 10V$	X7R or X5R
C_{SS}	3300pF	$\geq 10V$	X7R or X5R
R_{FBT}	232k Ω	1%	
R_{FBB}	44.2k Ω	1%	
R_{PG}	10k Ω	1%	

**Figure 19. External Component Values
($V_{OUT} = 5.0 V$)**
9.2.1 Design Requirements

The design procedure requires a few typical design parameters. See [Table 2](#) below.

Table 2. Design Parameters

Design Parameter	Value
Input Voltage (V_{IN})	Range from 3.0 V to 17 V
Output Voltage (V_{OUT})	Range from 0.9 V to 6 V
Output Current (I_{OUT})	Up to 1000 mA
Softstart time (T_{SS})	Minimum of 0.5 ms recommended

9.2.2 Detailed Design Procedure
9.2.2.1 Input Capacitor (C_{IN})

Low ESR multi-layer ceramic capacitors (MLCC) are recommended for the input capacitor of the LMZ21701. Using a $\geq 10 \mu\text{F}$ ceramic input capacitor in ≥ 0805 (2012 metric) case size with 25 V rating typically provides sufficient V_{IN} bypass. Use of multiple capacitors can also be considered. Ceramic capacitors with X5R and X7R temperature characteristics are recommended. These provide an optimal balance between small size, cost, reliability, and performance for applications with limited space. The DC voltage bias characteristics of the capacitors must be considered when selecting the DC voltage rating and case size of these components. The effective capacitance of an MLCC is typically reduced by the DC voltage bias applied across its terminals. Selecting a part with larger capacitance, larger case size, or higher voltage rating can compensate for the capacitance loss due to the DC voltage bias effect. For example, a 10 μF , X7R, 25 V rated capacitor used under 12V DC bias may have approximately 8 μF effective capacitance in a 1210 (3225 metric) case size and about 6 μF in a 1206 (3216 metric) case size. As another example, a 10 μF , X7R, 16 V rated capacitor in a 1210 (3225 metric) case size used at 12 V DC bias may have approximately 5.5 μF effective capacitance. Check the capacitor specifications published by the manufacturer.

9.2.2.2 Output Capacitor (C_{OUT})

Similarly to the input capacitor, it is recommended to use low ESR multi-layer ceramic capacitors for C_{OUT} . Ceramic capacitors with X5R and X7R temperature characteristics are recommended. Use 10 μF or larger value and consider the DC voltage bias characteristics of the capacitor when choosing the case size and voltage rating. For stability, the output capacitor should be in the 10 μF – 200 μF effective capacitance range.

9.2.2.3 Softstart Capacitor (C_{SS})

The softstart capacitor is chosen according to the desired softstart time. As described in the [Softstart and Tracking Function](#) section the softstart time $T_{SS} = C_{SS} \times 1.25 \text{ V} / 2.9 \mu\text{A}$.

A minimum C_{SS} value of 1000 pF is required for monotonic V_{OUT} ramp up.

9.2.2.4 Power Good Resistor (R_{PG})

If the Power Good function is used, a pull up resistor R_{PG} is necessary from the PG pin to an external pull-up voltage.

The minimum R_{PG} value is restricted by the pull down current capability of the internal pull down device.

$$R_{PG-MIN} = V_{PULL-UP} / 2 \text{ mA} \quad (5)$$

The maximum R_{PG} value is based on the maximum PG leakage current and the minimum “logic high” level system requirements:

$$R_{PG-MAX} = (V_{PULL-UP} - V_{LOGIC-HIGH}) / I_{LKG_PG} \quad (6)$$

9.2.2.5 Feedback Resistors (R_{FBB} and R_{FBT})

The feedback resistors R_{FBB} and R_{FBT} set the desired output voltage. Choose R_{FBB} less than 400 k Ω and calculate the value for R_{FBT} using the following formula:

$$R_{FBT} = R_{FBB} \times (V_{OUT} / 0.8 - 1) \quad (7)$$

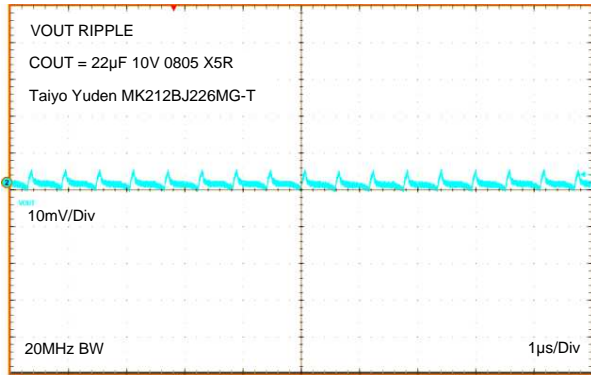

Figure 26. 20 MHz Oscilloscope Bandwidth Output Voltage Ripple $V_{OUT} = 1.2\text{ V}$

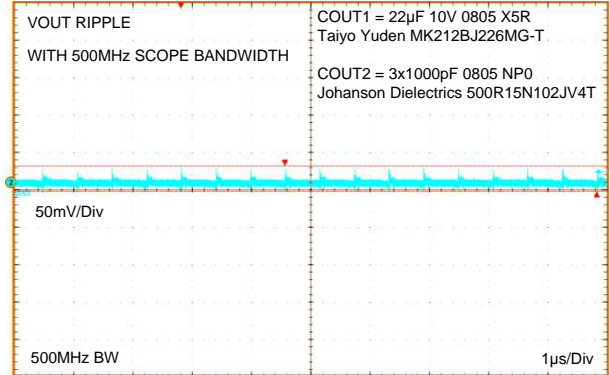

Figure 27. 500 MHz Oscilloscope Bandwidth, 3x1000 pF additional output capacitance Output Voltage Ripple and HF Noise $V_{OUT} = 1.2\text{ V}$

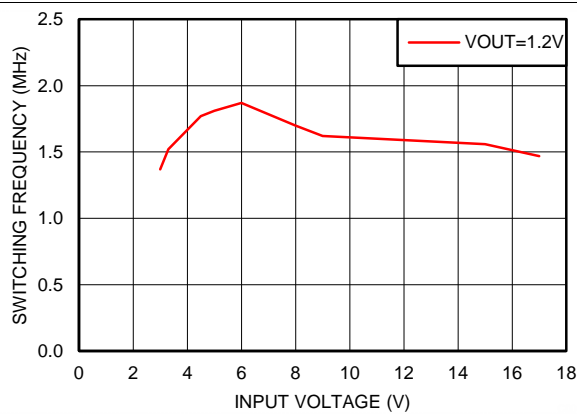

Figure 28. Typical Switching Frequency at 1000 mA Load $V_{OUT} = 1.2\text{ V}$

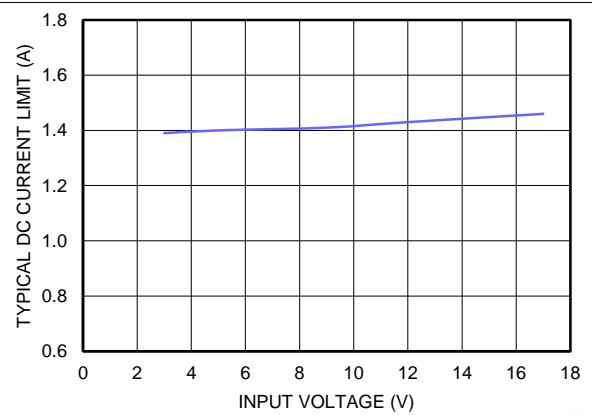

Figure 29. Typical Current Limit $V_{OUT} = 1.2\text{ V}$, $T_A = 85\text{ }^\circ\text{C}$

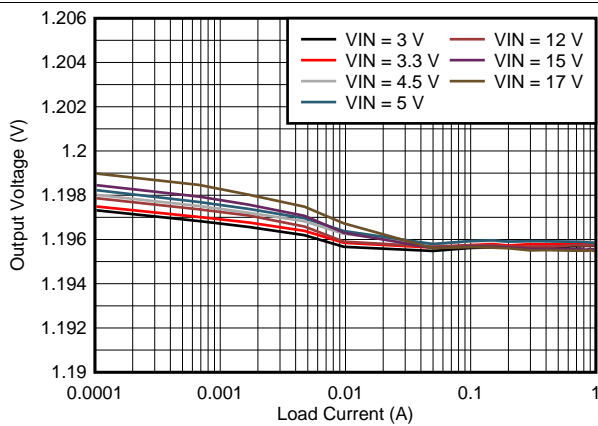

Figure 30. Line and Load Regulation $V_{OUT} = 1.2\text{ V}$

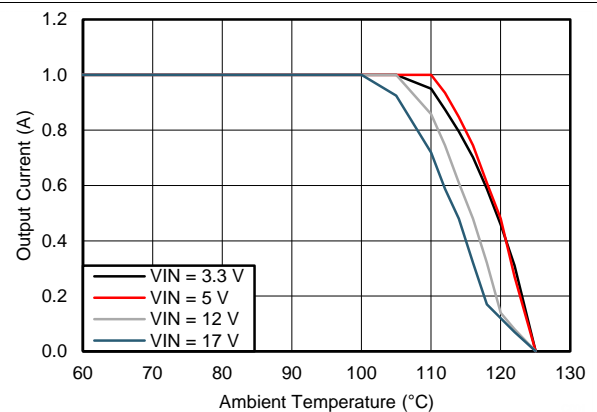

Figure 31. Thermal Derating for $\theta_{JA} = 47\text{ }^\circ\text{C/W}$, $V_{OUT} = 1.2\text{ V}$

LMZ21701

SNVS853D – AUGUST 2012 – REVISED NOVEMBER 2014

www.ti.com

9.2.3.2 $V_{OUT} = 1.8\text{ V}$

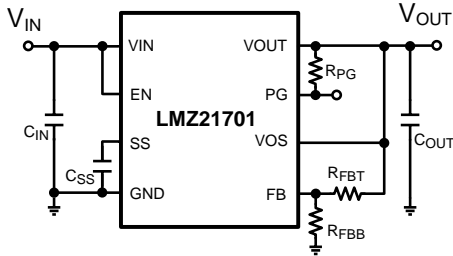

Figure 32. Typical Applications Circuit

COMPONENT VALUES FOR $V_{OUT}=1.8\text{V}$			
C_{IN}	22 μF	$\geq 25\text{V}$	X7R or X5R
C_{OUT}	22 μF	$\geq 10\text{V}$	X7R or X5R
C_{SS}	3300pF	$\geq 10\text{V}$	X7R or X5R
R_{FBT}	147k Ω	1%	
R_{FBB}	118k Ω	1%	
R_{PG}	10k Ω	1%	

Figure 33. External Component Values ($V_{OUT} = 1.8\text{ V}$)

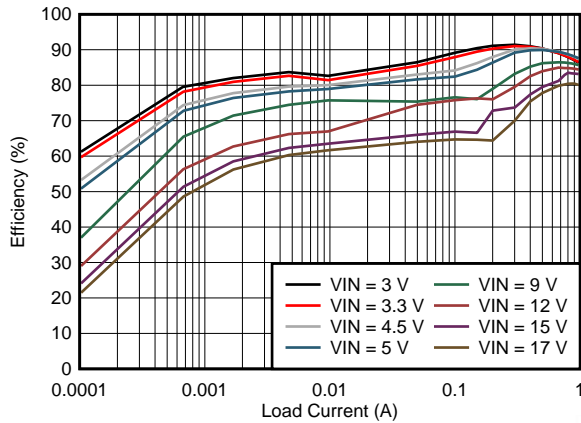

Figure 34. Efficiency $V_{OUT} = 1.8\text{ V}$

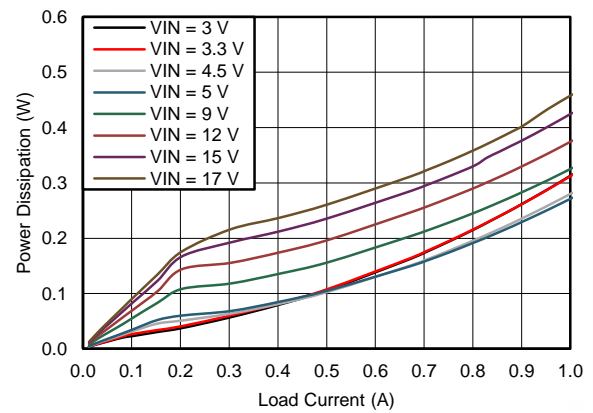

Figure 35. Power Dissipation $V_{OUT} = 1.8\text{ V}$

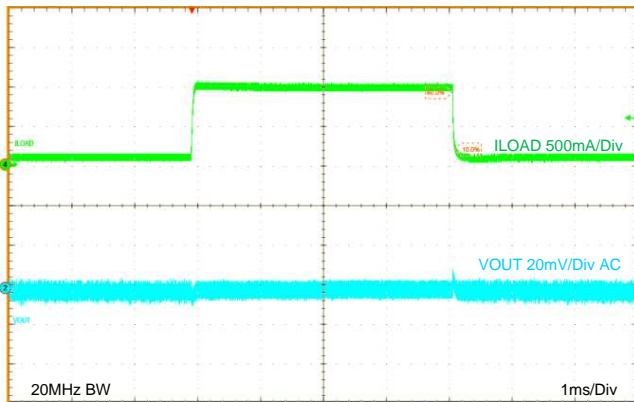

Figure 36. Load Transient $V_{OUT} = 1.8\text{ V}$

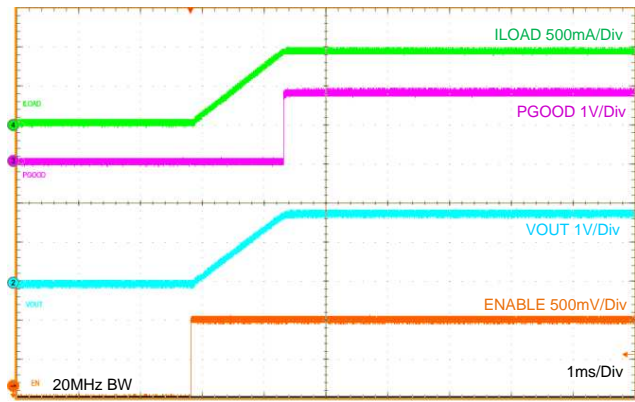

Figure 37. Startup $V_{OUT} = 1.8\text{ V}$

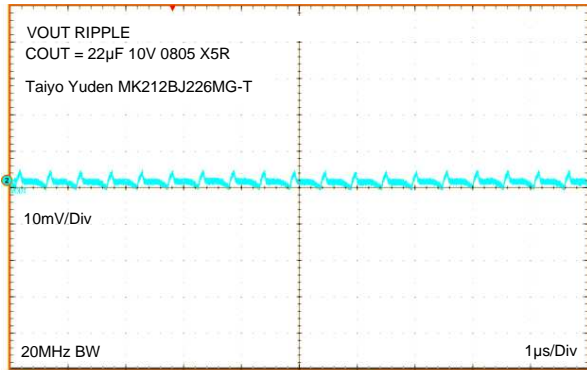

Figure 38. 20 MHz Oscilloscope Bandwidth Output Voltage Ripple $V_{OUT} = 1.8\text{ V}$

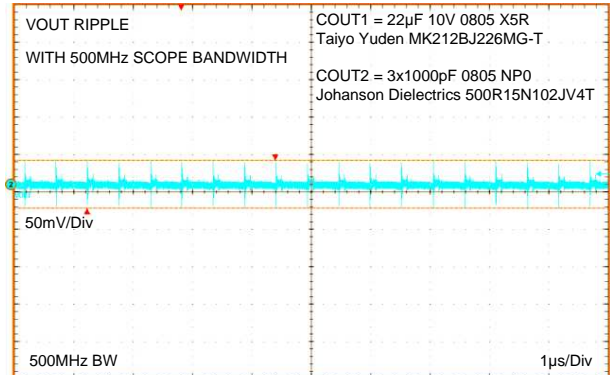

Figure 39. 500 MHz Oscilloscope Bandwidth, 3x1000 pF additional output capacitance Output Voltage Ripple and HF Noise $V_{OUT} = 1.8\text{ V}$

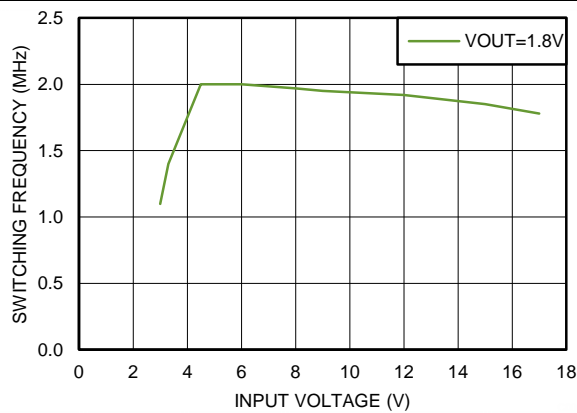

Figure 40. Typical Switching Frequency at 1000 mA Load $V_{OUT} = 1.8\text{ V}$

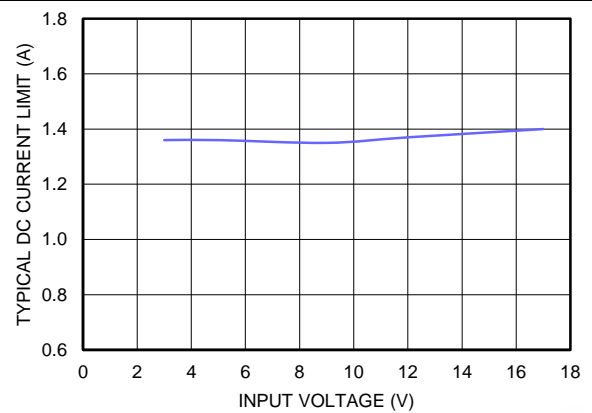

Figure 41. Typical Current Limit $V_{OUT} = 1.8\text{ V}$, $T_A = 85\text{ }^\circ\text{C}$

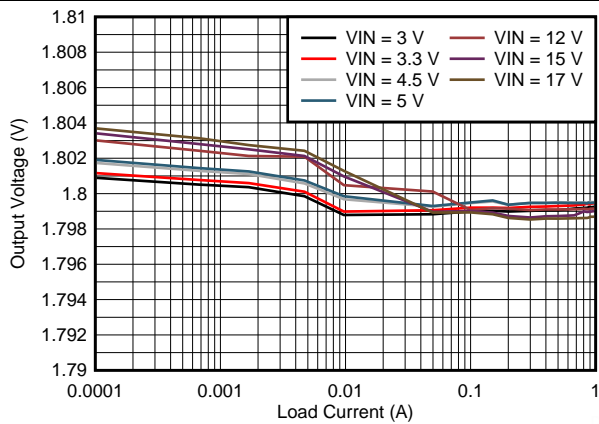

Figure 42. Line and Load Regulation $V_{OUT} = 1.8\text{ V}$

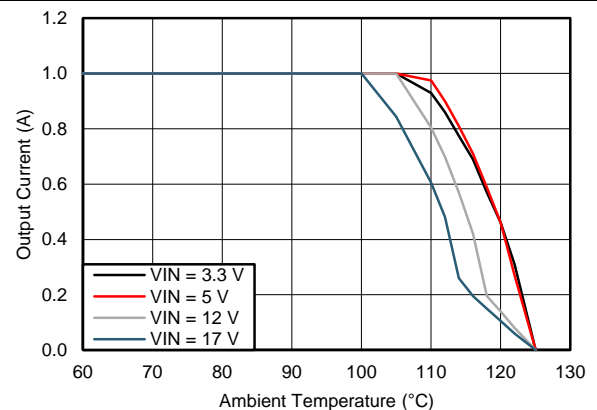

Figure 43. Thermal Derating for $\theta_{JA} = 47^\circ\text{C/W}$ $V_{OUT} = 1.8\text{ V}$

LMZ21701

SNVS853D – AUGUST 2012 – REVISED NOVEMBER 2014

www.ti.com

9.2.3.3 $V_{OUT} = 2.5\text{ V}$

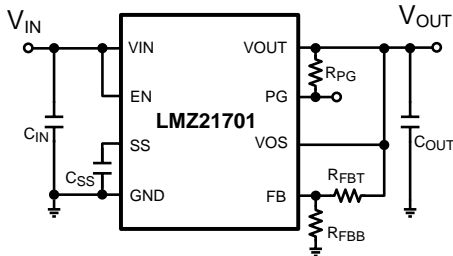

Figure 44. Typical Applications Circuit

COMPONENT VALUES FOR $V_{OUT}=2.5\text{V}$			
C_{IN}	22 μF	$\geq 25\text{V}$	X7R or X5R
C_{OUT}	22 μF	$\geq 10\text{V}$	X7R or X5R
C_{SS}	3300pF	$\geq 10\text{V}$	X7R or X5R
R_{FBT}	357k Ω	1%	
R_{FBB}	169k Ω	1%	
R_{PG}	10k Ω	1%	

Figure 45. External Component Values ($V_{OUT} = 2.5\text{ V}$)

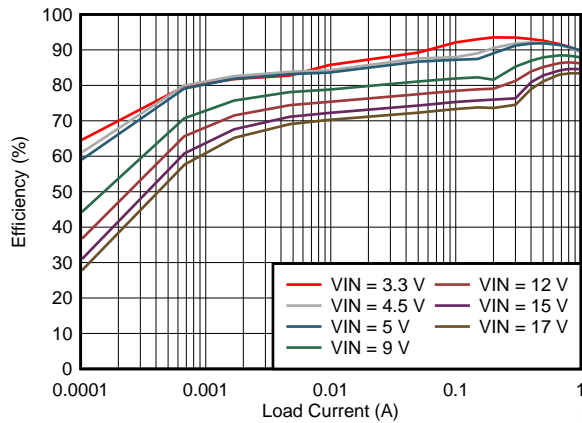

Figure 46. Efficiency $V_{OUT} = 2.5\text{ V}$

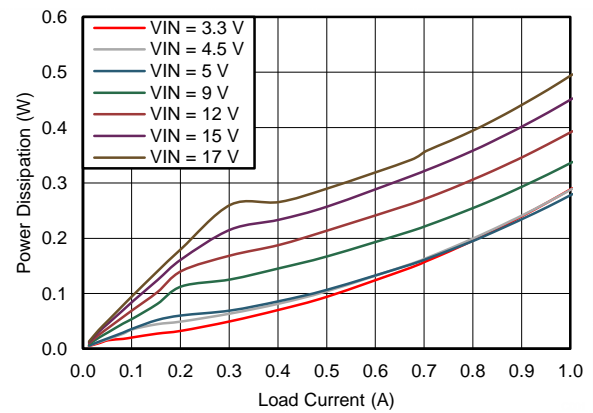

Figure 47. Power Dissipation $V_{OUT} = 2.5\text{ V}$

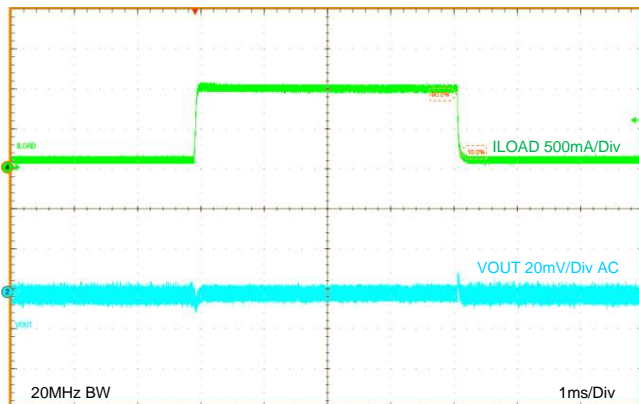

Figure 48. Load Transient $V_{OUT} = 2.5\text{ V}$

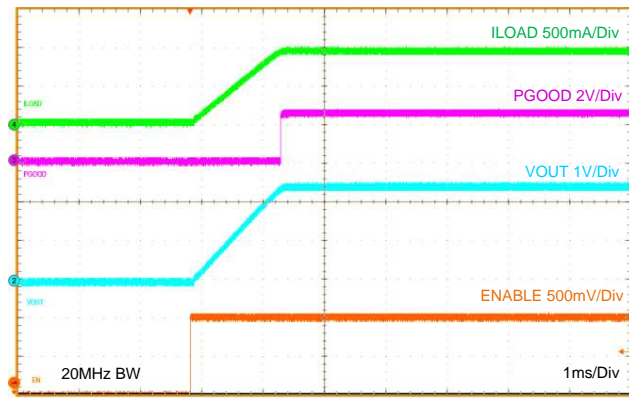

Figure 49. Startup $V_{OUT} = 2.5\text{ V}$

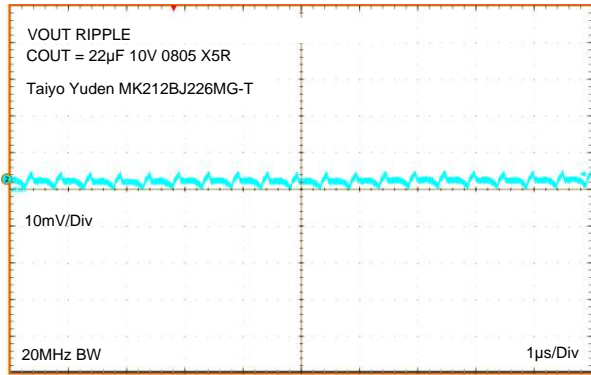

Figure 50. 20MHz Oscilloscope Bandwidth Output Voltage Ripple $V_{OUT} = 2.5\text{ V}$

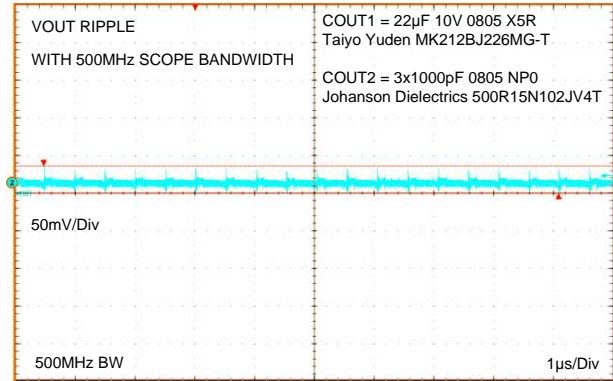

Figure 51. 500 MHz Oscilloscope Bandwidth, 3x1000 pF additional output capacitance Output Voltage Ripple and HF Noise $V_{OUT} = 2.5\text{ V}$

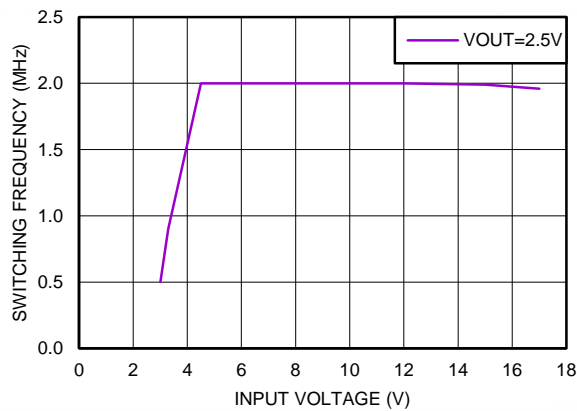

Figure 52. Typical Switching Frequency at 1000 mA Load $V_{OUT} = 2.5\text{ V}$

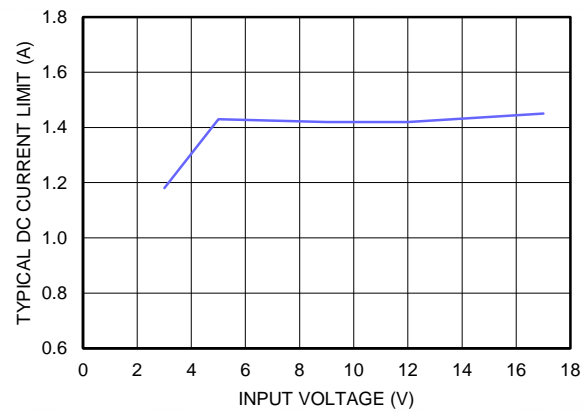

Figure 53. Typical Current Limit $V_{OUT} = 2.5\text{ V}$, $T_A = 85\text{ }^\circ\text{C}$

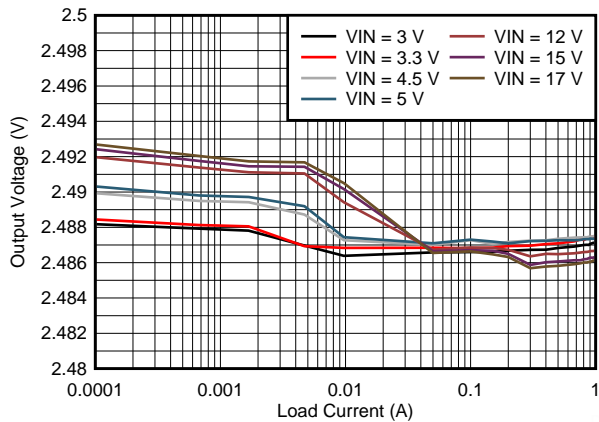

Figure 54. Line and Load Regulation $V_{OUT} = 2.5\text{ V}$

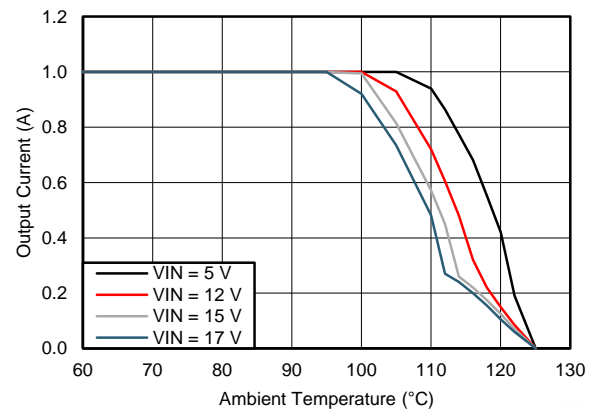

Figure 55. Thermal Derating for $\theta_{JA} = 47\text{ }^\circ\text{C/W}$, $V_{OUT} = 2.5\text{ V}$

LMZ21701

SNVS853D – AUGUST 2012 – REVISED NOVEMBER 2014

www.ti.com

9.2.3.4 $V_{OUT} = 3.3\text{ V}$

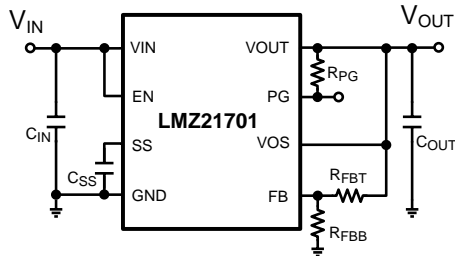

Figure 56. Typical Applications Circuit

COMPONENT VALUES FOR $V_{OUT}=3.3\text{ V}$			
C_{IN}	22 μF	$\geq 25\text{ V}$	X7R or X5R
C_{OUT}	22 μF	$\geq 10\text{ V}$	X7R or X5R
C_{SS}	3300pF	$\geq 10\text{ V}$	X7R or X5R
R_{FBT}	1.21M Ω	1%	
R_{FBB}	383k Ω	1%	
R_{PG}	10k Ω	1%	

Figure 57. External Component Values ($V_{OUT} = 3.3\text{ V}$)

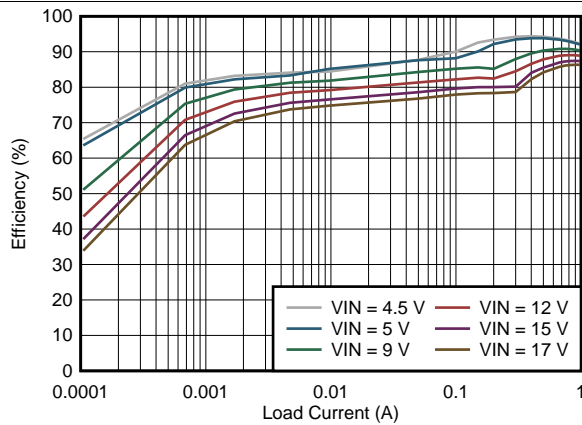

Figure 58. Efficiency $V_{OUT} = 3.3\text{ V}$

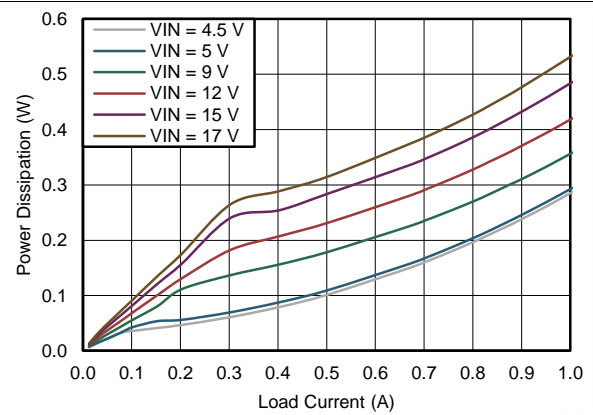

Figure 59. Power Dissipation $V_{OUT} = 3.3\text{ V}$



Figure 60. Load Transient $V_{OUT} = 3.3\text{ V}$

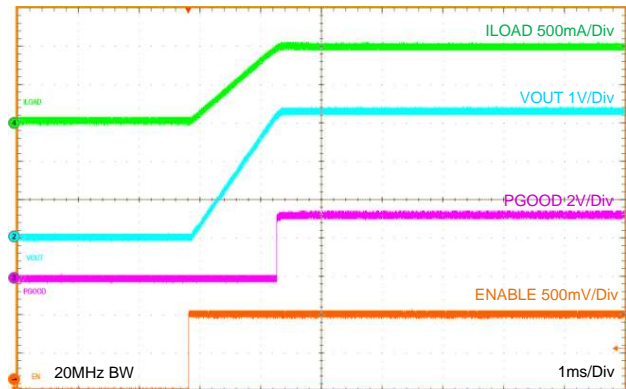

Figure 61. Startup $V_{OUT} = 3.3\text{ V}$

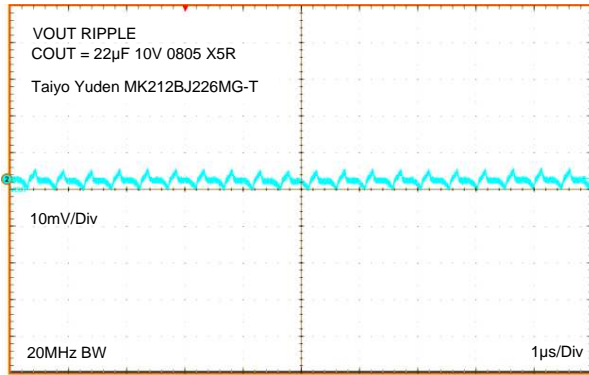

Figure 62. 20 MHz Oscilloscope Bandwidth Output Voltage Ripple $V_{OUT} = 3.3\text{ V}$

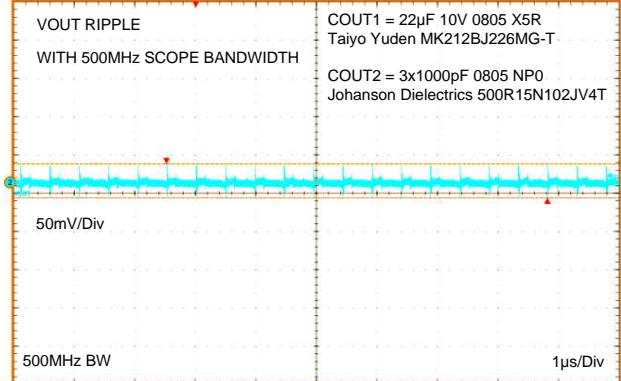

Figure 63. 500 MHz Oscilloscope Bandwidth, 3x1000 pF additional output capacitance Output Voltage Ripple and HF Noise $V_{OUT} = 3.3\text{ V}$

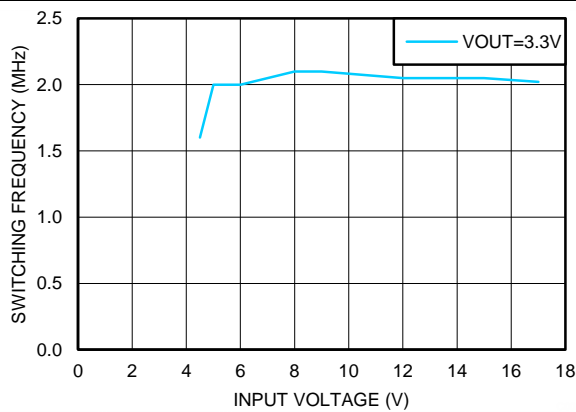

Figure 64. Typical Switching Frequency at 1000 mA Load $V_{OUT} = 3.3\text{ V}$

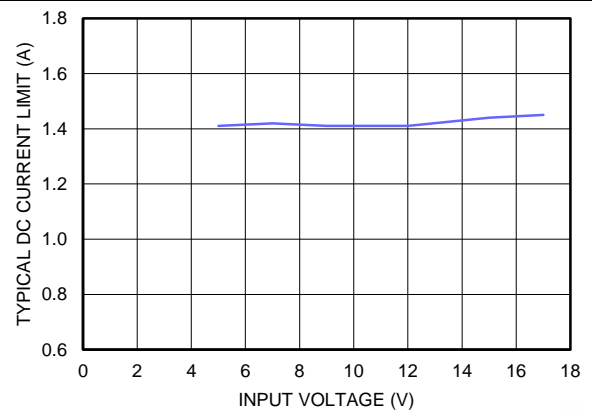

Figure 65. Typical Current Limit $V_{OUT} = 3.3\text{ V}$, $T_A = 85\text{ }^\circ\text{C}$

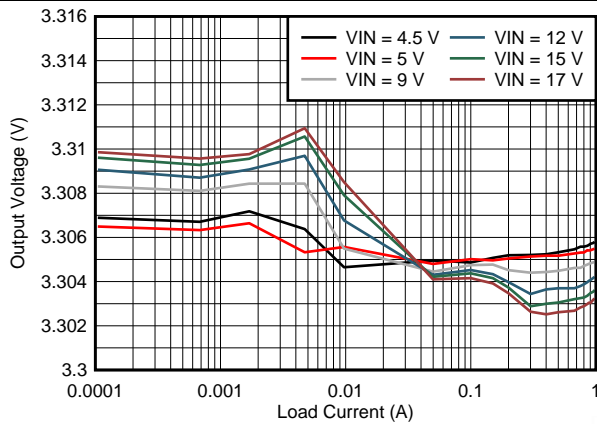

Figure 66. Line and Load Regulation $V_{OUT} = 3.3\text{ V}$

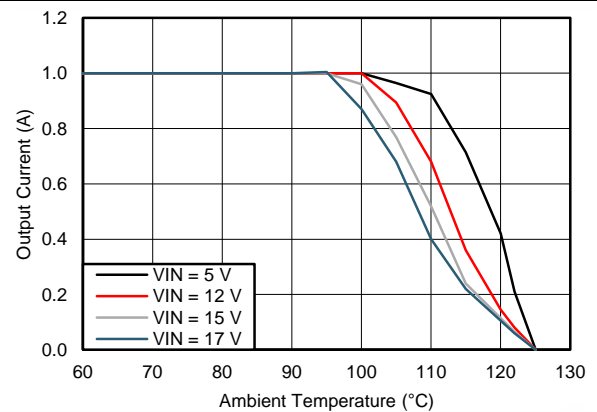

Figure 67. Thermal Derating for $\theta_{JA} = 47\text{ }^\circ\text{C/W}$, $V_{OUT} = 3.3\text{ V}$

LMZ21701

SNVS853D – AUGUST 2012 – REVISED NOVEMBER 2014

www.ti.com

9.2.3.5 $V_{OUT} = 5.0\text{ V}$

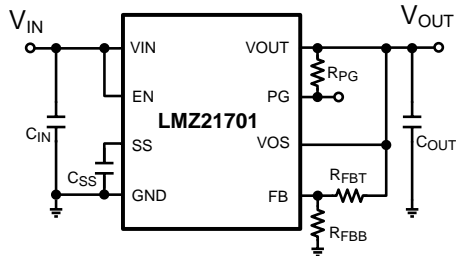

Figure 68. Typical Applications Circuit

COMPONENT VALUES FOR $V_{OUT}=5.0\text{V}$			
C_{IN}	22 μF	$\geq 25\text{V}$	X7R or X5R
C_{OUT}	22 μF	$\geq 10\text{V}$	X7R or X5R
C_{SS}	3300pF	$\geq 10\text{V}$	X7R or X5R
R_{FBT}	232k Ω	1%	
R_{FBB}	44.2k Ω	1%	
R_{PG}	10k Ω	1%	

Figure 69. External Component Values ($V_{OUT} = 5.0\text{ V}$)

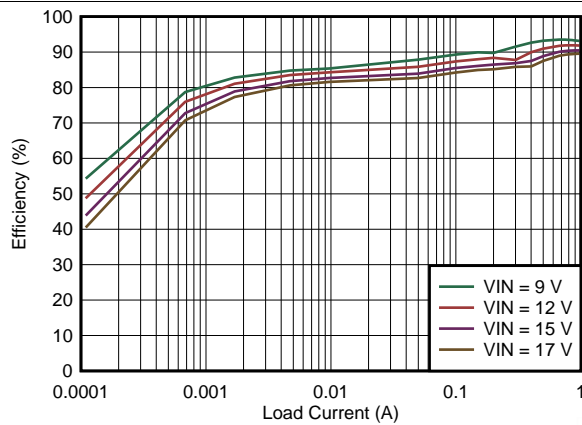

Figure 70. Efficiency $V_{OUT} = 5.0\text{ V}$

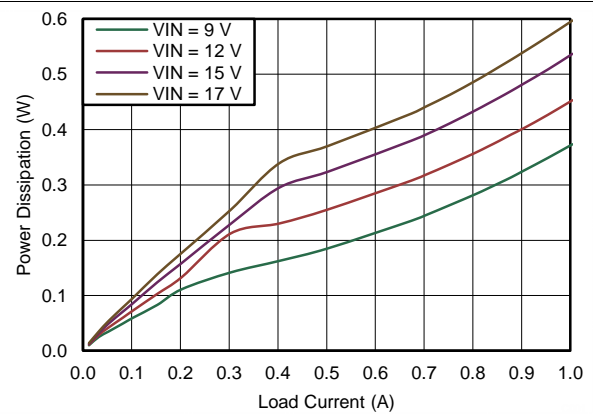

Figure 71. Power Dissipation $V_{OUT} = 5.0\text{ V}$

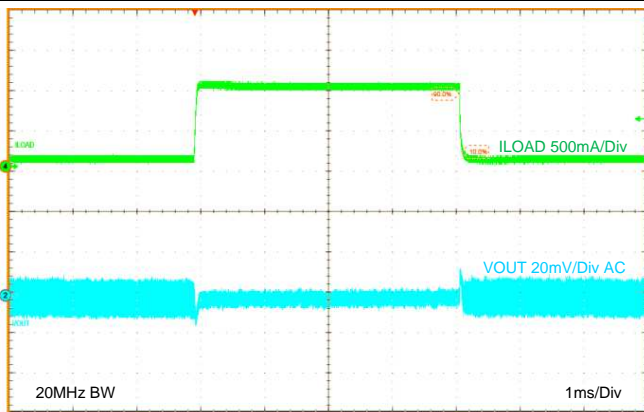

Figure 72. Load Transient $V_{OUT} = 5.0\text{ V}$

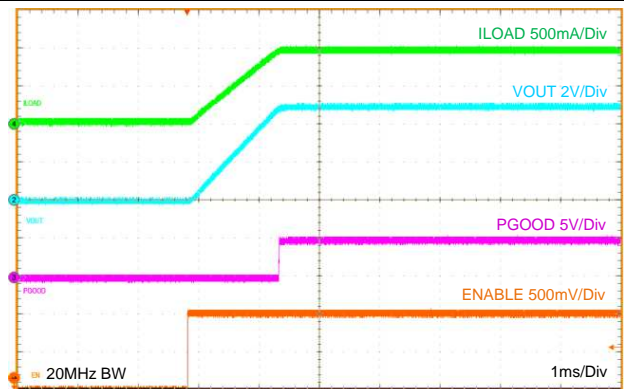

Figure 73. Startup $V_{OUT} = 5.0\text{ V}$

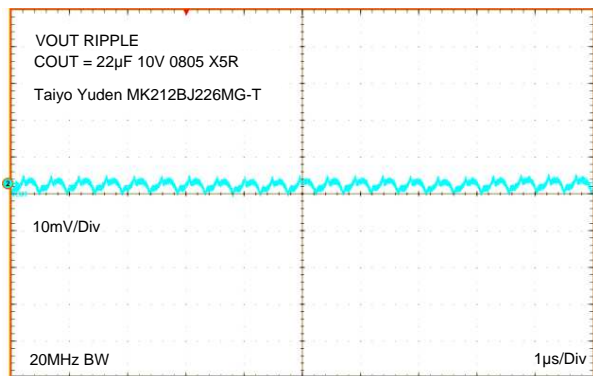

Figure 74. 20MHz Oscilloscope Bandwidth Output Voltage Ripple $V_{OUT} = 5.0\text{ V}$

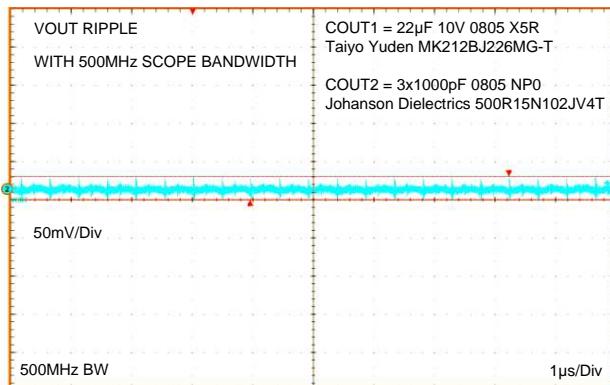

Figure 75. 500 MHz Oscilloscope Bandwidth, 3x1000 pF additional output capacitance Output Voltage Ripple and HF Noise $V_{OUT} = 5.0\text{ V}$

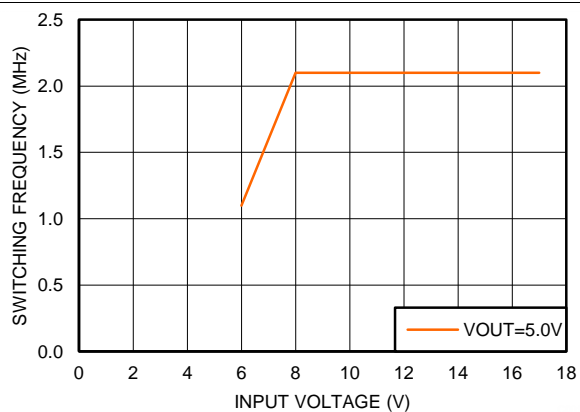

Figure 76. Typical Switching Frequency at 1000 mA Load $V_{OUT} = 5.0\text{ V}$

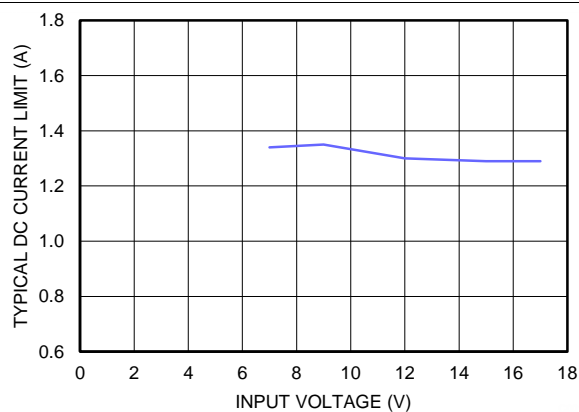

Figure 77. Typical Current Limit $V_{OUT} = 5.0\text{ V}$, $T_A = 85\text{ }^\circ\text{C}$

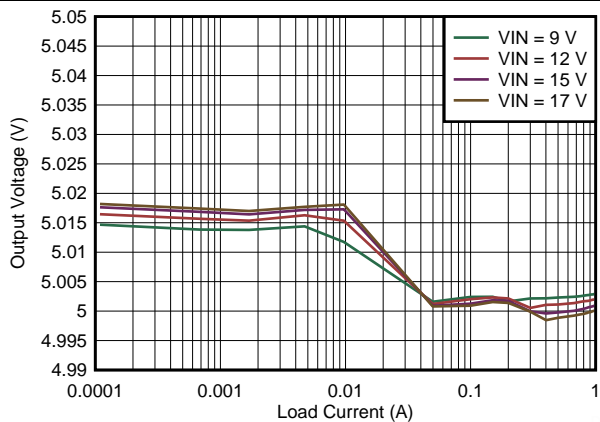

Figure 78. Line and Load Regulation $V_{OUT} = 5.0\text{ V}$

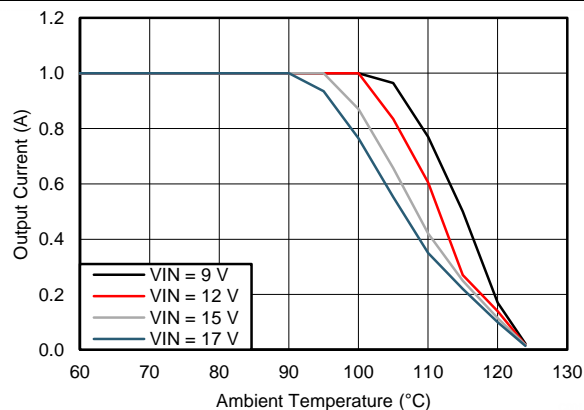

Figure 79. Thermal Derating for $\theta_{JA} = 47\text{ }^\circ\text{C/W}$, $V_{OUT} = 5.0\text{ V}$

9.3 Do's and Don'ts

- DO NOT exceed the [Absolute Maximum Ratings](#).
- DO NOT exceed the [Recommended Operating Conditions](#).
- DO NOT exceed the [Handling Ratings](#).
- DO follow the [Detailed Design Procedure](#).
- DO follow the PCB [Layout Guidelines](#) and [Layout Example](#).
- DO follow the [Power Supply Recommendations](#).
- DO visit the [TI E2E Community Support Forum](#) to have your questions answered and designs reviewed.

10 Power Supply Recommendations

10.1 Voltage Range

The voltage of the input supply must not exceed the [Absolute Maximum Ratings](#) and the [Recommended Operating Conditions](#)⁽¹⁾ of the LMZ21701.

10.2 Current Capability

The input supply must be able to supply the required input current to the LMZ21701 converter. The required input current depends on the application's minimum required input voltage (V_{IN-MIN}), the required output power ($V_{OUT} \times I_{OUT-MAX}$), and the converter efficiency (η).

$$I_{IN} = V_{OUT} \times I_{OUT-MAX} / (V_{IN-MIN} \times \eta)$$

For example, for a design with 10 V minimum input voltage, 5 V output, and 1.0 A maximum load, considering 90 % conversion efficiency, the required input current is 0.556 A.

10.3 Input Connection

Long input connection cables can cause issues with the normal operation of any buck converter.

10.3.1 Voltage Drops

Using long input wires to connect the supply to the input of any converter adds impedance in series with the input supply. This impedance can cause a voltage drop at the VIN pin of the converter when the output of the converter is loaded. If the input voltage is near the minimum operating voltage, this added voltage drop can cause the converter to drop out or reset. If long wires are used during testing, it is recommended to add some bulk (i.e. electrolytic) capacitance at the input of the converter.

10.3.2 Stability

The added inductance of long input cables together with the ceramic (and low ESR) input capacitor can result in an under damped RLC network at the input of the Buck converter. This can cause oscillations on the input and instability. If long wires are used, it is recommended to add some electrolytic capacitance in parallel with the ceramic input capacitor. The electrolytic capacitor's ESR will improve the damping.

Use an electrolytic capacitor with $C_{ELECTROLYTIC} \geq 4 \times C_{CERAMIC}$ and $ESR_{ELECTROLYTIC} \approx \sqrt{L_{CABLE} / C_{CERAMIC}}$

For example, two cables (one for V_{IN} and one for GND), each 1 meter (~3 ft) long with ~1.0 mm diameter (18 AWG), placed 1 cm (~0.4 in) apart will form a rectangular loop resulting in about 1.2 μ H of inductance. The inductance in this example can be decreased to almost half if the input wires are twisted. Based on a 22 μ F ceramic input capacitor, the recommended parallel $C_{ELECTROLYTIC}$ is $\geq 88 \mu$ F. Using a 100 μ F capacitor will be sufficient. The recommended $ESR_{ELECTROLYTIC} \approx 0.23 \Omega$ or larger, based on about 1.2 μ H of inductance and 22 μ F of ceramic input capacitance.

See application note [SNVA489C](#) for more details on input filter design.

(1) Operating Ratings indicate conditions for which the device is intended to be functional, but do not guarantee specific performance limits. For guaranteed specifications, see the [Electrical Characteristics](#) section.

11 Layout

11.1 Layout Guidelines

The PCB layout is critical for the proper operation of any DC-DC switching converter. Although using modules can simplify the PCB layout process, care should still be taken to minimize the inductance in the high di/dt loops and to protect sensitive nodes. The following guidelines should be followed when designing a board layout with the LMZ21701:

11.1.1 Minimize the High di/dt Loop Area

The input capacitor, the V_{IN} terminal, and the GND terminal of the LMZ21701 form a high di/dt loop. Place the input capacitor as close as possible to the VIN and GND terminals of the module IC. This minimizes the area of the high di/dt loop and results in lower inductance in the switching current path. Lower inductance in the switching current path translates to lower voltage spikes on the internal switch node and lower noise on the output voltage. Make the copper traces between the input capacitor and the VIN and GND terminals wide and short for better current handling and minimized parasitic inductance.

11.1.2 Protect the Sensitive Nodes in the Circuit

The feedback node is a sensitive circuit which can pick up noise. Make the feedback node as small as possible. This can be achieved by placing the feedback divider as close as possible to the IC. Use thin traces to the feedback pin in order to minimize the parasitic capacitance to other nodes. The feedback network carries very small current and thick traces are not necessary. Another sensitive node to protect is the VOS pin. Use a thin and short trace from the V_{OUT} terminal of the output capacitor to the VOS pin. The VOS pin is right next to the GND terminal. For very noisy systems, a small (0402 or 0201) 0.1 μ F capacitor can be placed from VOS to GND to filter high frequency noise on the VOS line.

11.1.3 Provide Thermal Path and Shielding

Using the available layers in the PCB can help provide additional shielding and improved thermal performance. Large unbroken GND copper areas provide good thermal and return current paths. Flood unused PCB area with GND copper. Use thermal vias to connect the GND copper between layers.

The required board area for proper thermal dissipation can be estimated using the power dissipation curves for the desired output voltage and the package thermal resistance vs. board area curve. Refer to the power dissipation graphs in the [Typical Characteristics](#) section. Using the power dissipation (P_{DISS}) for the designed input and output voltage and the max operating ambient temperature T_A for the application, estimate the required thermal resistance $R_{\theta JA}$ with the following expression.

$$R_{\theta JA - \text{REQUIRED}} \leq (125 \text{ }^\circ\text{C} - T_A) / P_{DISS} \quad (8)$$

Then use [Figure 80](#) to estimate the board copper area required to achieve the calculated thermal resistance.

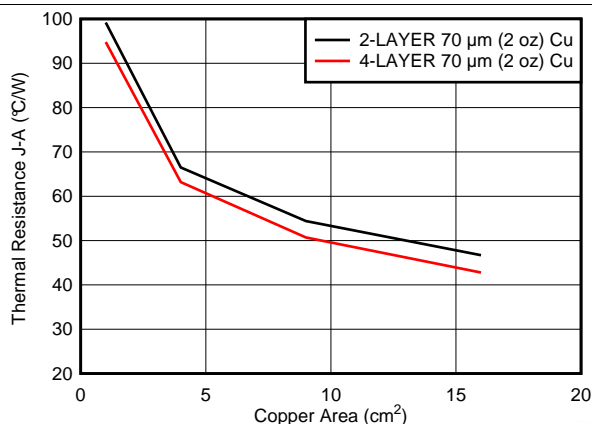

Figure 80. Package Thermal Resistance vs. Board Copper Area

Layout Guidelines (continued)

For example, for a design with 12 V input and 5 V output and 1 A load the power dissipation according to [Figure 7](#) is 0.53 W.

For 85 °C ambient temperature, the $R_{\theta JA-REQUIRED}$ is $\leq (125\text{ °C} - 85\text{ °C}) / 0.53\text{ W}$, or $\leq 75\text{ °C/W}$. Looking at [Figure 80](#) the minimum copper area required to achieve this thermal resistance with a 4-layer board and 70 μm (2 oz) copper is approximately 3 cm^2 .

11.2 Layout Example

The following example is for a 4-layer board. Layers 2 and 4 provide additional shielding and thermal path. If a 2-layer board is used, apply the Layer 1 and Layer 3 copper patterns for the top and bottom layers, respectively.

Layout Example (continued)

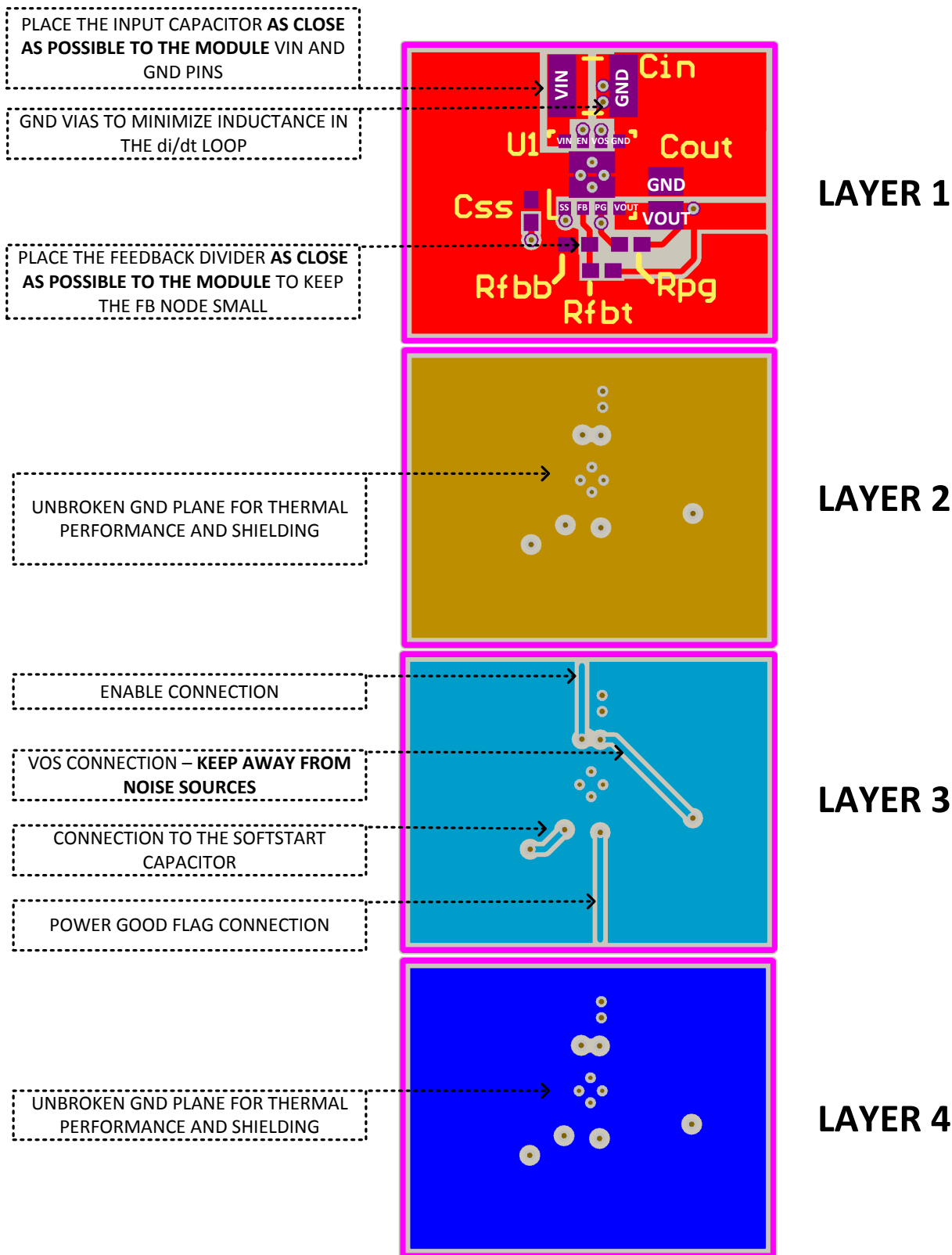

Figure 81. Layout example

Layout Example (continued)
11.2.1 High Density Layout Example for Space Constrained Applications
11.2.1.1 35 mm² Solution Size (Single Sided)

The following layout example uses 0805 case size components for the input and output capacitors and 0402 case size components for the rest of the passives.

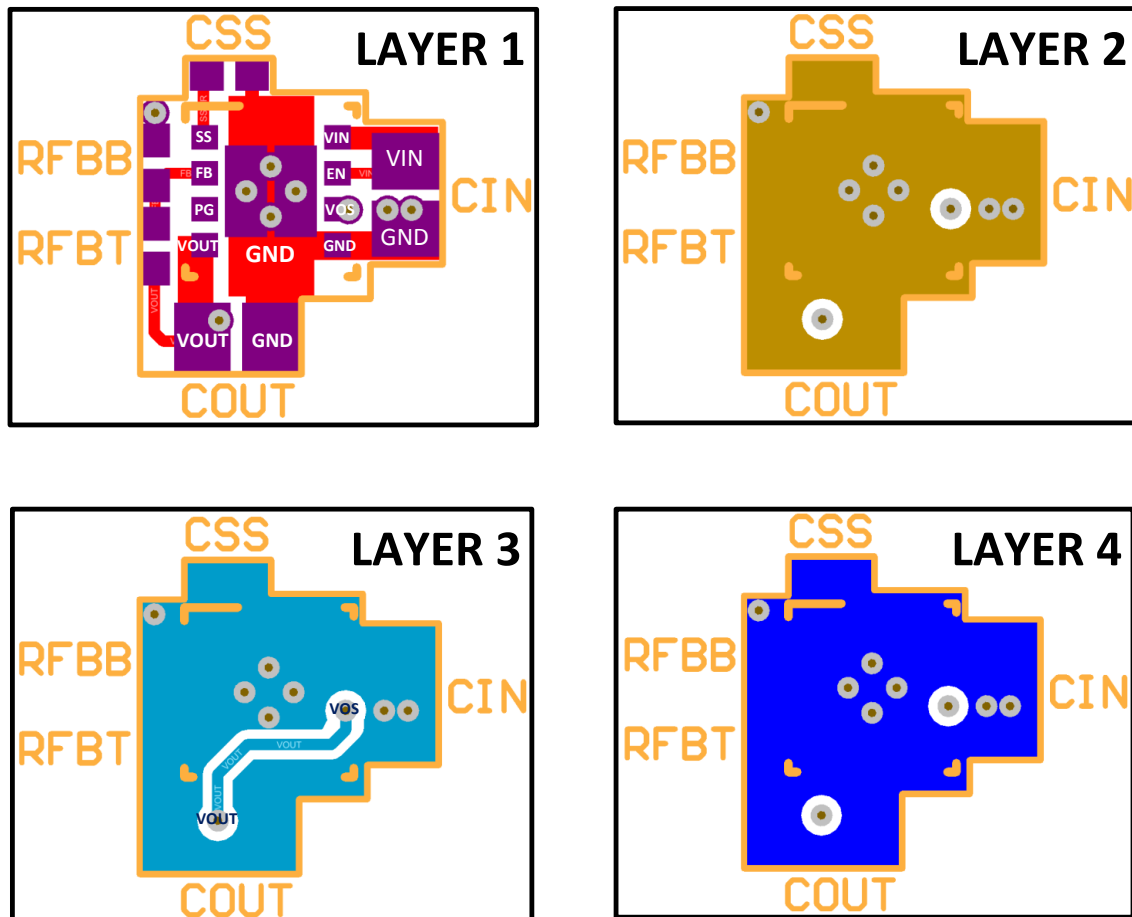

Figure 82. 35 mm² Solution Size (Single Sided)

12 Device and Documentation Support

12.1 Device Support

Visit the [TI E2E Community Support Forum](#) to have your questions answered and designs reviewed.

12.2 Trademarks

DCS-Control, MicroSiP are trademarks of Texas Instruments.

SIMPLE SWITCHER, WEBENCH are registered trademarks of Texas Instruments.

12.3 Electrostatic Discharge Caution



These devices have limited built-in ESD protection. The leads should be shorted together or the device placed in conductive foam during storage or handling to prevent electrostatic damage to the MOS gates.

12.4 Glossary

[SLYZ022](#) — *TI Glossary*.

This glossary lists and explains terms, acronyms, and definitions.

13 Mechanical, Packaging, and Orderable Information

The following pages include mechanical, packaging, and orderable information. This information is the most current data available for the designated devices. This data is subject to change without notice and revision of this document. For browser-based versions of this data sheet, refer to the left-hand navigation.

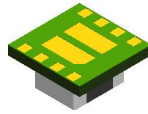

PACKAGE OUTLINE

SIL0008E

MicroSiP™ - 1.75 mm max height

MICRO SYSTEM IN PACKAGE

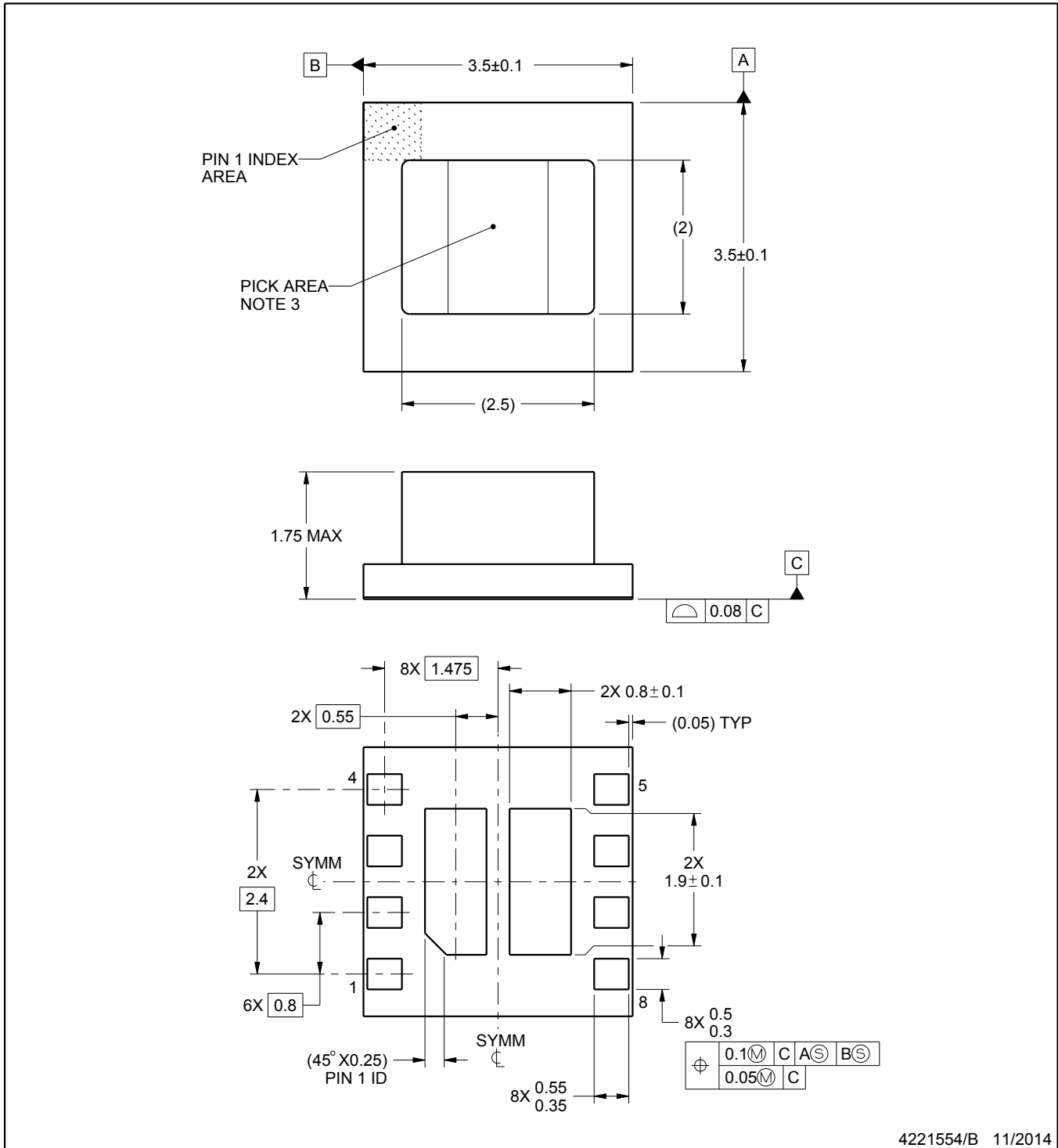

4221554/B 11/2014

MicroSiP is a trademark of Texas Instruments.

NOTES:

1. All linear dimensions are in millimeters. Any dimensions in parenthesis are for reference only. Dimensioning and tolerancing per ASME Y14.5M.
2. This drawing is subject to change without notice.
3. Pick and place nozzle ϕ 1.3 mm or smaller recommended.

EXAMPLE BOARD LAYOUT

SIL0008E

MicroSiP™ - 1.75 mm max height

MICRO SYSTEM IN PACKAGE

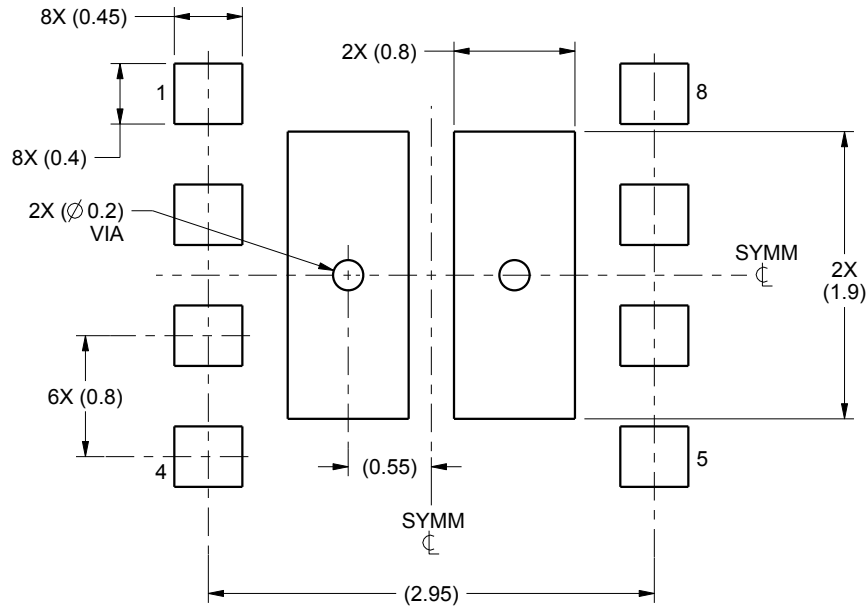

LAND PATTERN EXAMPLE
1:1 RATIO WITH PACKAGE SOLDER PADS
SCALE:20X

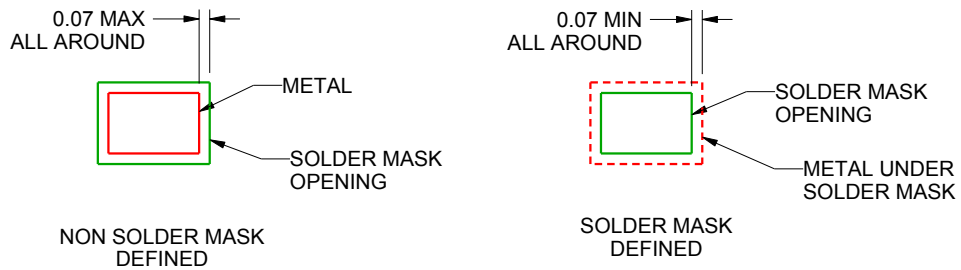

SOLDER MASK DETAILS
NOT TO SCALE

4221554/B 11/2014

NOTES: (continued)

4. This package is designed to be soldered to a thermal pad on the board. For more information, see Texas Instruments literature number SLUA271 (www.ti.com/lit/slua271).

EXAMPLE STENCIL DESIGN

SIL0008E

MicroSiP™ - 1.75 mm max height

MICRO SYSTEM IN PACKAGE

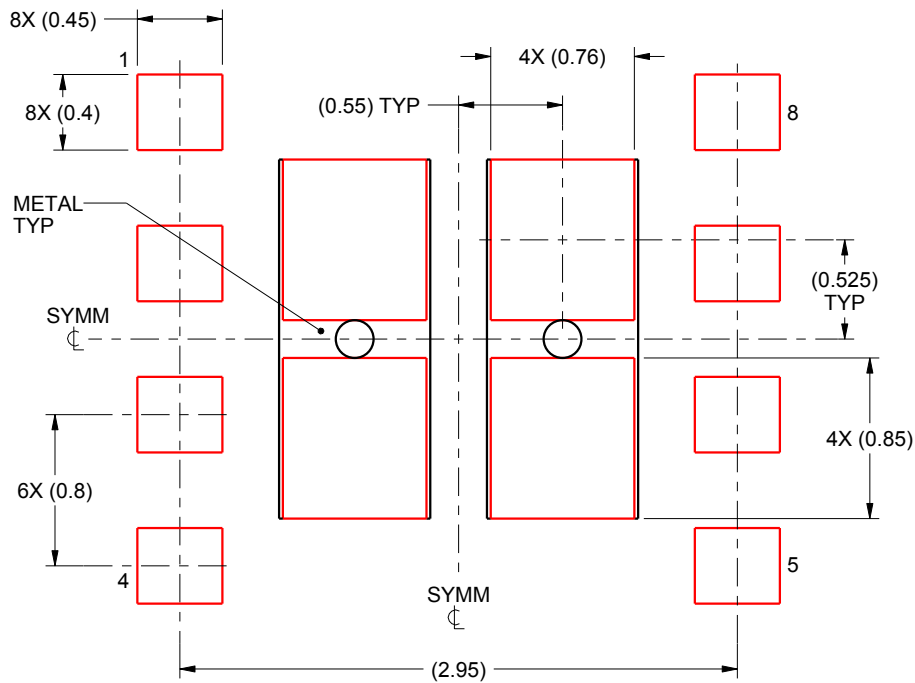

SOLDER PASTE EXAMPLE
BASED ON 0.125 mm THICK STENCIL

EXPOSED PAD
85% PRINTED SOLDER COVERAGE BY AREA
SCALE:25X

4221554/B 11/2014

NOTES: (continued)

5. Laser cutting apertures with trapezoidal walls and rounded corners may offer better paste release. IPC-7525 may have alternate design recommendations.

PACKAGING INFORMATION

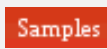
Orderable Device	Status (1)	Package Type	Package Drawing	Pins	Package Qty	Eco Plan (2)	Lead/Ball Finish (6)	MSL Peak Temp (3)	Op Temp (°C)	Device Marking (4/5)	Samples
LMZ21701SILR	ACTIVE	uSiP	SIL	8	3000	Green (RoHS & no Sb/Br)	Call TI	Level-3-260C-168 HR	-40 to 125	TXN7203EC EA 7485 1701 1701 7485 EA	
LMZ21701SILT	ACTIVE	uSiP	SIL	8	250	Green (RoHS & no Sb/Br)	Call TI	Level-3-260C-168 HR	-40 to 125	TXN7203EC EA 7485 1701 1701 7485 EA	

(1) The marketing status values are defined as follows:

ACTIVE: Product device recommended for new designs.

LIFEBUY: TI has announced that the device will be discontinued, and a lifetime-buy period is in effect.

NRND: Not recommended for new designs. Device is in production to support existing customers, but TI does not recommend using this part in a new design.

PREVIEW: Device has been announced but is not in production. Samples may or may not be available.

OBSOLETE: TI has discontinued the production of the device.

(2) Eco Plan - The planned eco-friendly classification: Pb-Free (RoHS), Pb-Free (RoHS Exempt), or Green (RoHS & no Sb/Br) - please check <http://www.ti.com/productcontent> for the latest availability information and additional product content details.

TBD: The Pb-Free/Green conversion plan has not been defined.

Pb-Free (RoHS): TI's terms "Lead-Free" or "Pb-Free" mean semiconductor products that are compatible with the current RoHS requirements for all 6 substances, including the requirement that lead not exceed 0.1% by weight in homogeneous materials. Where designed to be soldered at high temperatures, TI Pb-Free products are suitable for use in specified lead-free processes.

Pb-Free (RoHS Exempt): This component has a RoHS exemption for either 1) lead-based flip-chip solder bumps used between the die and package, or 2) lead-based die adhesive used between the die and leadframe. The component is otherwise considered Pb-Free (RoHS compatible) as defined above.

Green (RoHS & no Sb/Br): TI defines "Green" to mean Pb-Free (RoHS compatible), and free of Bromine (Br) and Antimony (Sb) based flame retardants (Br or Sb do not exceed 0.1% by weight in homogeneous material)

(3) MSL, Peak Temp. - The Moisture Sensitivity Level rating according to the JEDEC industry standard classifications, and peak solder temperature.

(4) There may be additional marking, which relates to the logo, the lot trace code information, or the environmental category on the device.

(5) Multiple Device Markings will be inside parentheses. Only one Device Marking contained in parentheses and separated by a "~" will appear on a device. If a line is indented then it is a continuation of the previous line and the two combined represent the entire Device Marking for that device.

(6) Lead/Ball Finish - Orderable Devices may have multiple material finish options. Finish options are separated by a vertical ruled line. Lead/Ball Finish values may wrap to two lines if the finish value exceeds the maximum column width.

Important Information and Disclaimer: The information provided on this page represents TI's knowledge and belief as of the date that it is provided. TI bases its knowledge and belief on information provided by third parties, and makes no representation or warranty as to the accuracy of such information. Efforts are underway to better integrate information from third parties. TI has taken and continues to take reasonable steps to provide representative and accurate information but may not have conducted destructive testing or chemical analysis on incoming materials and chemicals. TI and TI suppliers consider certain information to be proprietary, and thus CAS numbers and other limited information may not be available for release.

In no event shall TI's liability arising out of such information exceed the total purchase price of the TI part(s) at issue in this document sold by TI to Customer on an annual basis.

IMPORTANT NOTICE

Texas Instruments Incorporated (TI) reserves the right to make corrections, enhancements, improvements and other changes to its semiconductor products and services per JESD46, latest issue, and to discontinue any product or service per JESD48, latest issue. Buyers should obtain the latest relevant information before placing orders and should verify that such information is current and complete.

TI's published terms of sale for semiconductor products (<http://www.ti.com/sc/docs/stdterms.htm>) apply to the sale of packaged integrated circuit products that TI has qualified and released to market. Additional terms may apply to the use or sale of other types of TI products and services.

Reproduction of significant portions of TI information in TI data sheets is permissible only if reproduction is without alteration and is accompanied by all associated warranties, conditions, limitations, and notices. TI is not responsible or liable for such reproduced documentation. Information of third parties may be subject to additional restrictions. Resale of TI products or services with statements different from or beyond the parameters stated by TI for that product or service voids all express and any implied warranties for the associated TI product or service and is an unfair and deceptive business practice. TI is not responsible or liable for any such statements.

Buyers and others who are developing systems that incorporate TI products (collectively, "Designers") understand and agree that Designers remain responsible for using their independent analysis, evaluation and judgment in designing their applications and that Designers have full and exclusive responsibility to assure the safety of Designers' applications and compliance of their applications (and of all TI products used in or for Designers' applications) with all applicable regulations, laws and other applicable requirements. Designer represents that, with respect to their applications, Designer has all the necessary expertise to create and implement safeguards that (1) anticipate dangerous consequences of failures, (2) monitor failures and their consequences, and (3) lessen the likelihood of failures that might cause harm and take appropriate actions. Designer agrees that prior to using or distributing any applications that include TI products, Designer will thoroughly test such applications and the functionality of such TI products as used in such applications.

TI's provision of technical, application or other design advice, quality characterization, reliability data or other services or information, including, but not limited to, reference designs and materials relating to evaluation modules, (collectively, "TI Resources") are intended to assist designers who are developing applications that incorporate TI products; by downloading, accessing or using TI Resources in any way, Designer (individually or, if Designer is acting on behalf of a company, Designer's company) agrees to use any particular TI Resource solely for this purpose and subject to the terms of this Notice.

TI's provision of TI Resources does not expand or otherwise alter TI's applicable published warranties or warranty disclaimers for TI products, and no additional obligations or liabilities arise from TI providing such TI Resources. TI reserves the right to make corrections, enhancements, improvements and other changes to its TI Resources. TI has not conducted any testing other than that specifically described in the published documentation for a particular TI Resource.

Designer is authorized to use, copy and modify any individual TI Resource only in connection with the development of applications that include the TI product(s) identified in such TI Resource. NO OTHER LICENSE, EXPRESS OR IMPLIED, BY ESTOPPEL OR OTHERWISE TO ANY OTHER TI INTELLECTUAL PROPERTY RIGHT, AND NO LICENSE TO ANY TECHNOLOGY OR INTELLECTUAL PROPERTY RIGHT OF TI OR ANY THIRD PARTY IS GRANTED HEREIN, including but not limited to any patent right, copyright, mask work right, or other intellectual property right relating to any combination, machine, or process in which TI products or services are used. Information regarding or referencing third-party products or services does not constitute a license to use such products or services, or a warranty or endorsement thereof. Use of TI Resources may require a license from a third party under the patents or other intellectual property of the third party, or a license from TI under the patents or other intellectual property of TI.

TI RESOURCES ARE PROVIDED "AS IS" AND WITH ALL FAULTS. TI DISCLAIMS ALL OTHER WARRANTIES OR REPRESENTATIONS, EXPRESS OR IMPLIED, REGARDING RESOURCES OR USE THEREOF, INCLUDING BUT NOT LIMITED TO ACCURACY OR COMPLETENESS, TITLE, ANY EPIDEMIC FAILURE WARRANTY AND ANY IMPLIED WARRANTIES OF MERCHANTABILITY, FITNESS FOR A PARTICULAR PURPOSE, AND NON-INFRINGEMENT OF ANY THIRD PARTY INTELLECTUAL PROPERTY RIGHTS. TI SHALL NOT BE LIABLE FOR AND SHALL NOT DEFEND OR INDEMNIFY DESIGNER AGAINST ANY CLAIM, INCLUDING BUT NOT LIMITED TO ANY INFRINGEMENT CLAIM THAT RELATES TO OR IS BASED ON ANY COMBINATION OF PRODUCTS EVEN IF DESCRIBED IN TI RESOURCES OR OTHERWISE. IN NO EVENT SHALL TI BE LIABLE FOR ANY ACTUAL, DIRECT, SPECIAL, COLLATERAL, INDIRECT, PUNITIVE, INCIDENTAL, CONSEQUENTIAL OR EXEMPLARY DAMAGES IN CONNECTION WITH OR ARISING OUT OF TI RESOURCES OR USE THEREOF, AND REGARDLESS OF WHETHER TI HAS BEEN ADVISED OF THE POSSIBILITY OF SUCH DAMAGES.

Unless TI has explicitly designated an individual product as meeting the requirements of a particular industry standard (e.g., ISO/TS 16949 and ISO 26262), TI is not responsible for any failure to meet such industry standard requirements.

Where TI specifically promotes products as facilitating functional safety or as compliant with industry functional safety standards, such products are intended to help enable customers to design and create their own applications that meet applicable functional safety standards and requirements. Using products in an application does not by itself establish any safety features in the application. Designers must ensure compliance with safety-related requirements and standards applicable to their applications. Designer may not use any TI products in life-critical medical equipment unless authorized officers of the parties have executed a special contract specifically governing such use. Life-critical medical equipment is medical equipment where failure of such equipment would cause serious bodily injury or death (e.g., life support, pacemakers, defibrillators, heart pumps, neurostimulators, and implantables). Such equipment includes, without limitation, all medical devices identified by the U.S. Food and Drug Administration as Class III devices and equivalent classifications outside the U.S.

TI may expressly designate certain products as completing a particular qualification (e.g., Q100, Military Grade, or Enhanced Product). Designers agree that it has the necessary expertise to select the product with the appropriate qualification designation for their applications and that proper product selection is at Designers' own risk. Designers are solely responsible for compliance with all legal and regulatory requirements in connection with such selection.

Designer will fully indemnify TI and its representatives against any damages, costs, losses, and/or liabilities arising out of Designer's non-compliance with the terms and provisions of this Notice.