

Rectifier Diode Avalanche Diode

$$V_{RRM} = 1200-1800 \text{ V}$$

$$I_{F(RMS)} = 160 \text{ A}$$

$$I_{F(AV)M} = 110 \text{ A}$$

Replacements see page 3

V_{RSM} V	$V_{(BR)min}$ ① V	V_{RRM} V	Anode on stud	Cathode on stud
1300	-	1200	DS75-12B	DSI75-12B
1300	1300	1200	DSA75-12B	DSAI75-12B
1700	1760	1600	DSA75-16B	DSAI75-16B
1900	1950	1800	DSA75-18B	DSAI75-18B

① Only for Avalanche Diodes

DO-203 AB

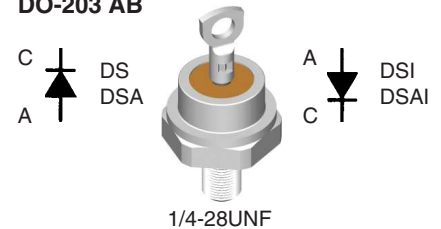

A = Anode C = Cathode

Symbol	Test Conditions	Maximum Ratings	
$I_{F(RMS)}$	$T_{VJ} = T_{VJM}$	160	A
$I_{F(AV)M}$	$T_{case} = 100^{\circ}\text{C}; 180^{\circ}$ sine	110	A
P_{RSM}	DSA(I) types, $T_{VJ} = T_{VJM}, t_p = 10 \mu\text{s}$	20	kW
I_{FSM}	$T_{VJ} = 45^{\circ}\text{C}; V_R = 0$	t = 10 ms (50 Hz), sine	1400 A
		t = 8.3 ms (60 Hz), sine	1500 A
	$T_{VJ} = T_{VJM}; V_R = 0$	t = 10 ms (50 Hz), sine	1250 A
		t = 8.3 ms (60 Hz), sine	1310 A
I^2t	$T_{VJ} = 45^{\circ}\text{C}; V_R = 0$	t = 10 ms (50 Hz), sine	9800 A ² s
		t = 8.3 ms (60 Hz), sine	9450 A ² s
	$T_{VJ} = T_{VJM}; V_R = 0$	t = 10 ms (50 Hz), sine	7820 A ² s
		t = 8.3 ms (60 Hz), sine	7210 A ² s
T_{VJ}		-40...+180	°C
T_{VJM}		180	°C
T_{stg}		-40...+180	°C
M_d	Mounting torque	2.4-4.5	Nm
		21-40	lb.in.
Weight		21	g

Features

- International standard package, JEDEC DO-203 AB (DO-5)
- Planar glassivated chips

Applications

- High power rectifiers
- Field supply for DC motors
- Power supplies

Advantages

- Space and weight savings
- Simple mounting
- Improved temperature and power cycling
- Reduced protection circuits

Symbol	Test Conditions	Characteristic Values	
I_R	$T_{VJ} = T_{VJM}, V_R = V_{RRM}$	≤ 6	mA
V_F	$I_F = 150 \text{ A}; T_{VJ} = 25^{\circ}\text{C}$	≤ 1.17	V
V_{T0}	For power-loss calculations only	0.75	V
r_T	$T_{VJ} = T_{VJM}$	2	mΩ
R_{thJC}	DC current	0.5	K/W
R_{thJH}	DC current	0.9	K/W
d_s	Creepage distance on surface	4.05	mm
d_A	Strike distance through air	3.9	mm
a	Max. allowable acceleration	100	m/s ²

Dimensions in mm (1 mm = 0.0394")

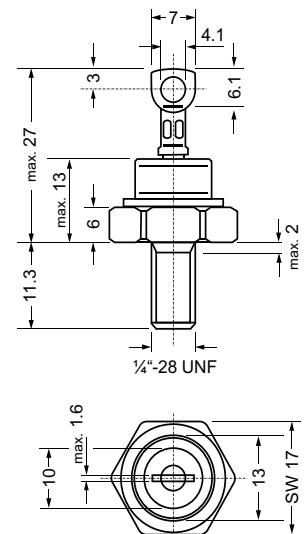

Data according to IEC 60747

IXYS reserves the right to change limits, test conditions and dimensions

20190129c

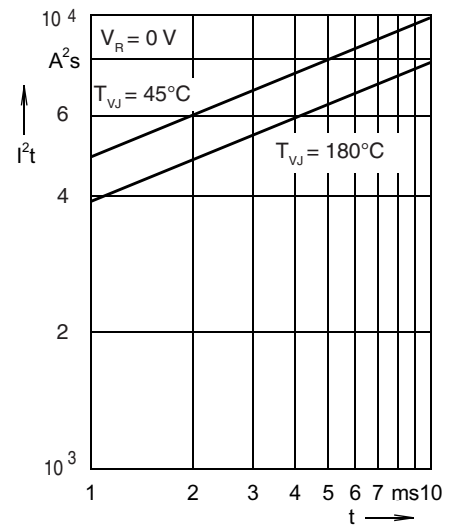
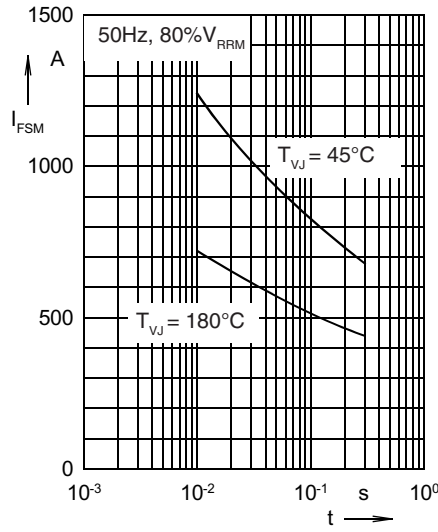
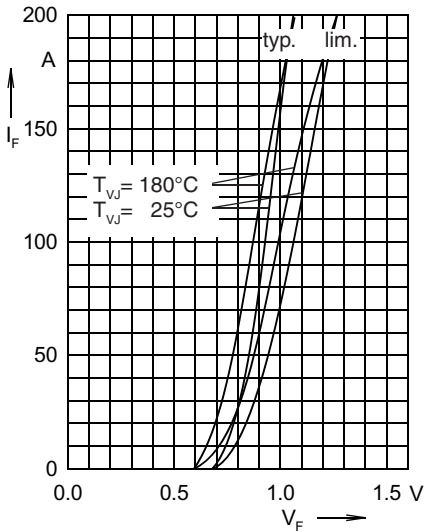

Fig. 1 Forward characteristics

Fig. 2 Surge overload current
 I_{FSM} : crest value, t: duration

Fig. 3 I^2t versus time (1-10 ms)

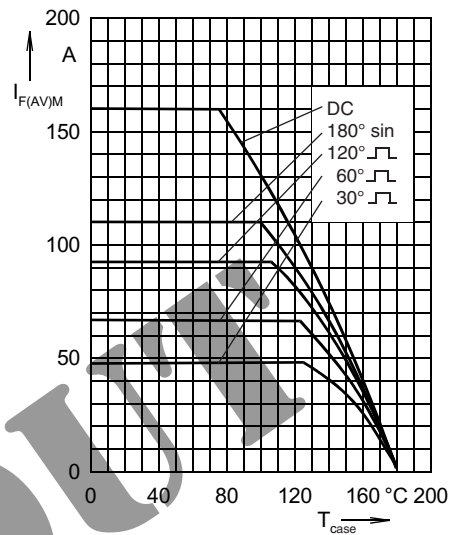
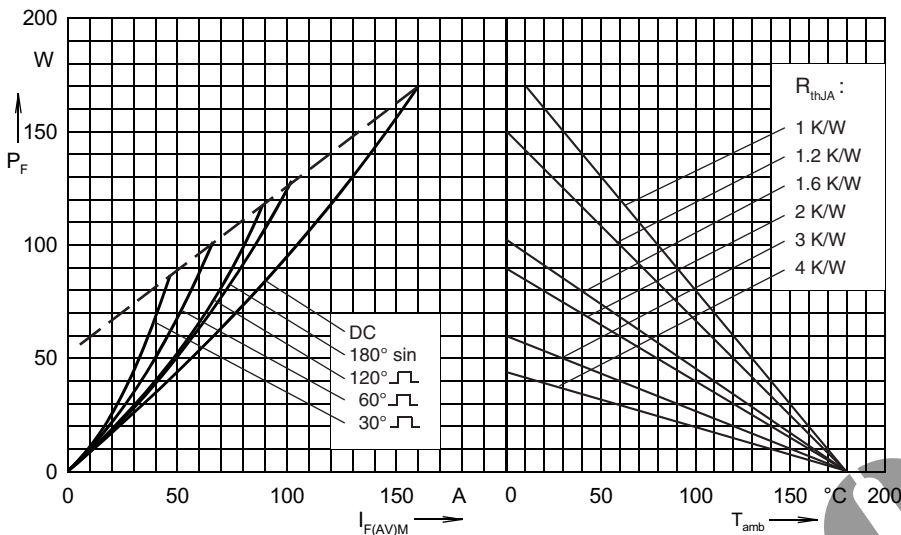
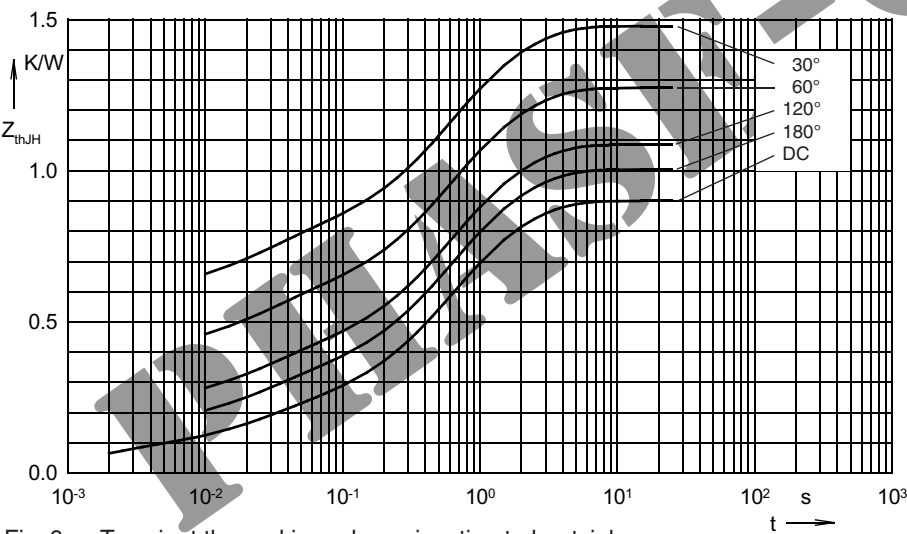

Fig. 4 Power dissipation versus forward current and ambient temperature

Fig. 5 Max. forward current at case temperature



R_{thJH} for various conduction angles d:

d	R_{thJH} (K/W)
DC	0.900
180°	1.028
120°	1.085
60°	1.272
30°	1.476

Constants for Z_{thJH} calculation:

i	R_{thi} (K/W)	t_i (s)
1	0.0731	0.0015
2	0.1234	0.0237
3	0.4035	0.4838
4	0.3000	1.5

Fig. 6 Transient thermal impedance junction to heatsink

Type	Replacements
DSI75-12B	DMA200X1600NA; DMA200XA1600NA
DSAI75-12B	DMA200X1600NA; DMA200XA1600NA; DAA200X1800NA; DAA200XA1800NA
DSAI75-16B	DMA200X1600NA; DMA200XA1600NA; DAA200X1800NA; DAA200XA1800NA
DSAI75-18B	DAA200X1800NA; DAA200XA1800NA
DS75-12B	DMA200X1600NA; DMA200XA1600NA
DSA75-12B	DMA200X1600NA; DMA200XA1600NA; DAA200X1800NA; DAA200XA1800NA
DSA75-16B	DMA200X1600NA; DMA200XA1600NA; DAA200X1800NA; DAA200XA1800NA
DSA75-18B	DAA200X1800NA; DAA200XA1800NA

PHASE-OUT

Mouser Electronics

Authorized Distributor

Click to View Pricing, Inventory, Delivery & Lifecycle Information:

[IXYS:](#)

[DS75-08B](#) [DSI75-08B](#) [DSA75-12B](#) [DSAI75-12B](#) [DS75-12B](#) [DSI75-12B](#) [DSA75-16B](#) [DSAI75-16B](#) [DSA75-18B](#)
[DSAI75-18B](#)