

# Thyristor Module

$$V_{RRM} = 2 \times 1600V$$

$$I_{TAV} = 700A$$

$$V_T = 1.16V$$

Phase leg

Part number

**MCMA700P1600CA**



Backside: isolated

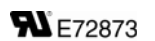

**Features / Advantages:**

- Thyristor for line frequency
- Planar passivated chip
- Long-term stability
- Direct Copper Bonded Al<sub>2</sub>O<sub>3</sub>-ceramic

**Applications:**

- Line rectifying 50/60 Hz
- Softstart AC motor control
- DC Motor control
- Power converter
- AC power control
- Lighting and temperature control

**Package: ComPack**

- Isolation Voltage: 4800 V~
- Industry standard outline
- RoHS compliant
- Base plate: Copper internally DCB isolated
- Advanced power cycling

Rectifier			Ratings			
Symbol	Definition	Conditions	min.	typ.	max.	Unit
$V_{RSM/DSM}$	max. non-repetitive reverse/forward blocking voltage	$T_{VJ} = 25^{\circ}\text{C}$			1700	V
$V_{RRM/DRM}$	max. repetitive reverse/forward blocking voltage	$T_{VJ} = 25^{\circ}\text{C}$			1600	V
$I_{RD}$	reverse current, drain current	$V_{RD} = 1600\text{ V}$	$T_{VJ} = 25^{\circ}\text{C}$		2	mA
		$V_{RD} = 1600\text{ V}$	$T_{VJ} = 125^{\circ}\text{C}$		40	mA
$V_T$	forward voltage drop	$I_T = 700\text{ A}$	$T_{VJ} = 25^{\circ}\text{C}$		1.20	V
					1.45	V
		$I_T = 1400\text{ A}$	$T_{VJ} = 125^{\circ}\text{C}$		1.16	V
					1.46	V
$I_{TAV}$	average forward current	$T_C = 85^{\circ}\text{C}$ 180° sine	$T_{VJ} = 140^{\circ}\text{C}$		700	A
$V_{TO}$	threshold voltage	} for power loss calculation only	$T_{VJ} = 140^{\circ}\text{C}$		0.82	V
$r_T$	slope resistance				0.4	mΩ
$R_{thJC}$	thermal resistance junction to case				0.05	K/W
$R_{thCH}$	thermal resistance case to heatsink			0.02		K/W
$P_{tot}$	total power dissipation		$T_C = 25^{\circ}\text{C}$		2300	W
$I_{TSM}$	max. forward surge current	t = 10 ms; (50 Hz), sine	$T_{VJ} = 45^{\circ}\text{C}$		19.0	kA
		t = 8,3 ms; (60 Hz), sine	$V_R = 0\text{ V}$		20.5	kA
		t = 10 ms; (50 Hz), sine	$T_{VJ} = 140^{\circ}\text{C}$		16.2	kA
		t = 8,3 ms; (60 Hz), sine	$V_R = 0\text{ V}$		17.4	kA
$I^2t$	value for fusing	t = 10 ms; (50 Hz), sine	$T_{VJ} = 45^{\circ}\text{C}$		1.81	MA <sup>2</sup> s
		t = 8,3 ms; (60 Hz), sine	$V_R = 0\text{ V}$		1.75	MA <sup>2</sup> s
		t = 10 ms; (50 Hz), sine	$T_{VJ} = 140^{\circ}\text{C}$		1.30	MA <sup>2</sup> s
		t = 8,3 ms; (60 Hz), sine	$V_R = 0\text{ V}$		1.27	MA <sup>2</sup> s
$C_J$	junction capacitance	$V_R = 400\text{ V}$ f = 1 MHz	$T_{VJ} = 25^{\circ}\text{C}$		876	pF
$P_{GM}$	max. gate power dissipation	$t_p = 30\text{ }\mu\text{s}$	$T_C = 140^{\circ}\text{C}$		240	W
		$t_p = 300\text{ }\mu\text{s}$			120	W
$P_{GAV}$	average gate power dissipation				40	W
$(di/dt)_{cr}$	critical rate of rise of current	$T_{VJ} = 140^{\circ}\text{C}$ ; f = 50 Hz	repetitive, $I_T = 2100\text{ A}$		100	A/ $\mu\text{s}$
		$t_p = 200\text{ }\mu\text{s}$ ; $di_G/dt = 1\text{ A}/\mu\text{s}$ ; $I_G = 1\text{ A}$ ; $V_D = \frac{2}{3} V_{DRM}$	non-repet., $I_T = 700\text{ A}$		500	A/ $\mu\text{s}$
$(dv/dt)_{cr}$	critical rate of rise of voltage	$V_D = \frac{2}{3} V_{DRM}$ $R_{GK} = \infty$ ; method 1 (linear voltage rise)	$T_{VJ} = 140^{\circ}\text{C}$		1000	V/ $\mu\text{s}$
$V_{GT}$	gate trigger voltage	$V_D = 6\text{ V}$	$T_{VJ} = 25^{\circ}\text{C}$		2	V
			$T_{VJ} = -40^{\circ}\text{C}$		3	V
$I_{GT}$	gate trigger current	$V_D = 6\text{ V}$	$T_{VJ} = 25^{\circ}\text{C}$		300	mA
			$T_{VJ} = -40^{\circ}\text{C}$		400	mA
$V_{GD}$	gate non-trigger voltage	$V_D = \frac{2}{3} V_{DRM}$	$T_{VJ} = 140^{\circ}\text{C}$		0.25	V
$I_{GD}$	gate non-trigger current				10	mA
$I_L$	latching current	$t_p = 30\text{ }\mu\text{s}$	$T_{VJ} = 25^{\circ}\text{C}$		400	mA
		$I_G = 1\text{ A}$ ; $di_G/dt = 1\text{ A}/\mu\text{s}$				
$I_H$	holding current	$V_D = 6\text{ V}$ $R_{GK} = \infty$	$T_{VJ} = 25^{\circ}\text{C}$		300	mA
$t_{gd}$	gate controlled delay time	$V_D = \frac{1}{2} V_{DRM}$	$T_{VJ} = 25^{\circ}\text{C}$		2	$\mu\text{s}$
		$I_G = 1\text{ A}$ ; $di_G/dt = 1\text{ A}/\mu\text{s}$				
$t_q$	turn-off time	$V_R = 100\text{ V}$ ; $I_T = 700\text{ A}$ ; $V_D = \frac{2}{3} V_{DRM}$	$T_{VJ} = 140^{\circ}\text{C}$		350	$\mu\text{s}$
		$di/dt = 10\text{ A}/\mu\text{s}$ ; $dv/dt = 50\text{ V}/\mu\text{s}$ ; $t_p = 200\text{ }\mu\text{s}$				

Package ComPack		Ratings				
Symbol	Definition	Conditions	min.	typ.	max.	Unit
$I_{RMS}$	RMS current	per terminal			1200	A
$T_{VJ}$	virtual junction temperature		-40		140	°C
$T_{op}$	operation temperature		-40		125	°C
$T_{stg}$	storage temperature		-40		125	°C
<b>Weight</b>				500		g
$M_D$	mounting torque		3		5	Nm
$M_T$	terminal torque		12		14	Nm
$d_{Spp/APP}$	creepage distance on surface   striking distance through air	terminal to terminal	21.0			mm
$d_{Spb/Apb}$		terminal to backside	18.0			mm
$V_{ISOL}$	isolation voltage	t = 1 second	4800			V
		t = 1 minute	4000			V

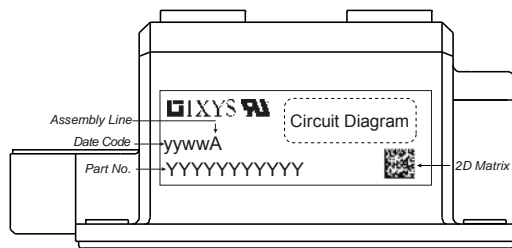

### Part description

- M = Module
- C = Thyristor (SCR)
- M = Thyristor
- A = (up to 1800V)
- 700 = Current Rating [A]
- P = Phase leg
- 1600 = Reverse Voltage [V]
- CA = ComPack

Ordering	Ordering Number	Marking on Product	Delivery Mode	Quantity	Code No.
Standard	MCMA700P1600CA	MCMA700P1600CA	Box	2	513835

### Equivalent Circuits for Simulation

\* on die level

$T_{VJ} = 140\text{ °C}$

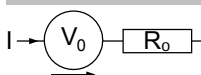

Thyristor

$V_{0\ max}$	threshold voltage	0.82	V
$R_{0\ max}$	slope resistance *	0.21	mΩ

## Outlines ComPack

A (2:1)

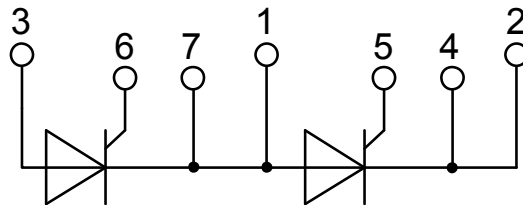
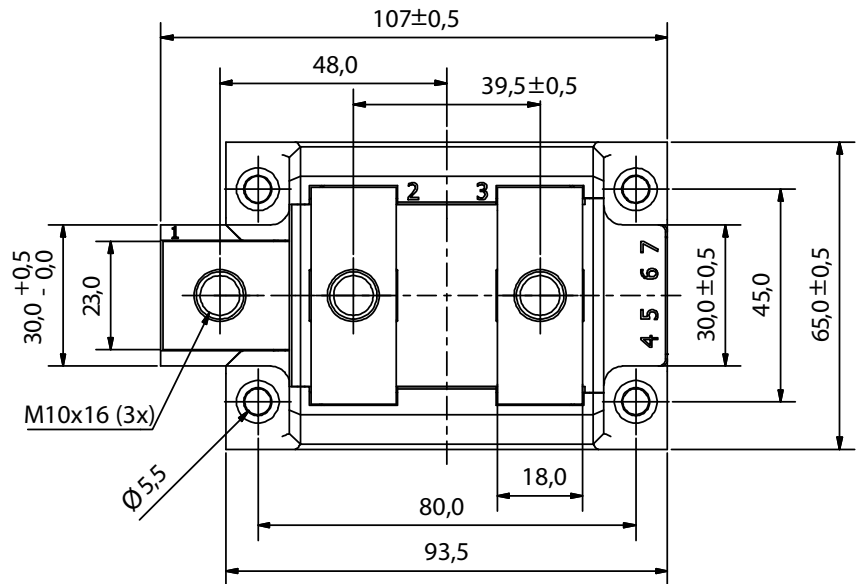
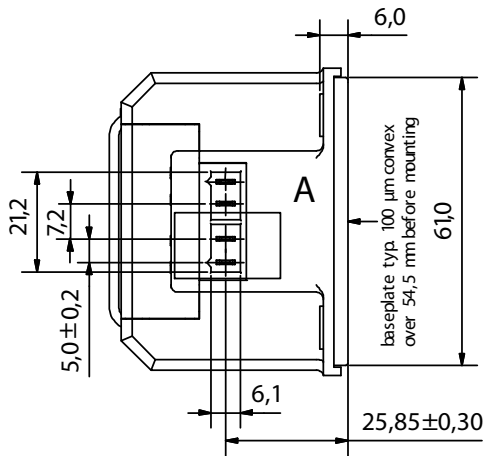
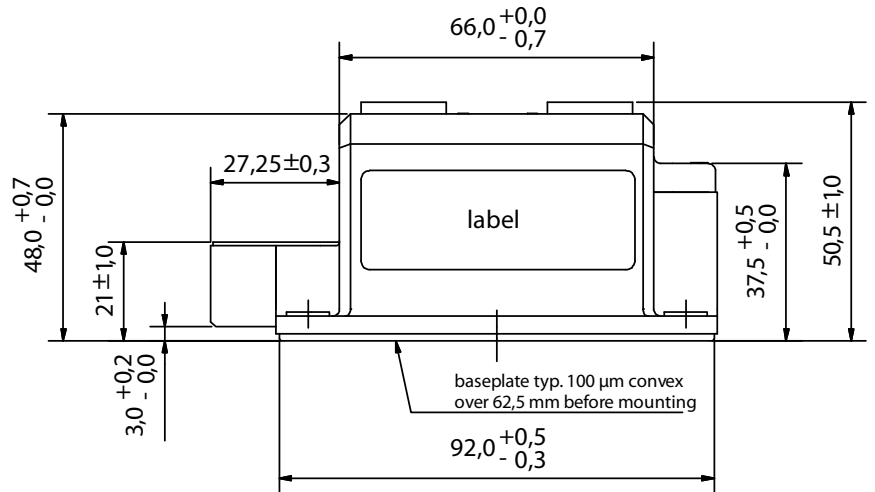
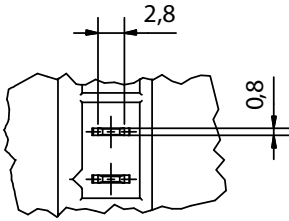

## Thyristor

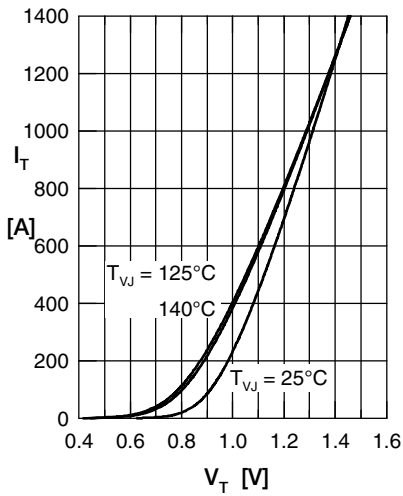

Fig. 1 Forward characteristics

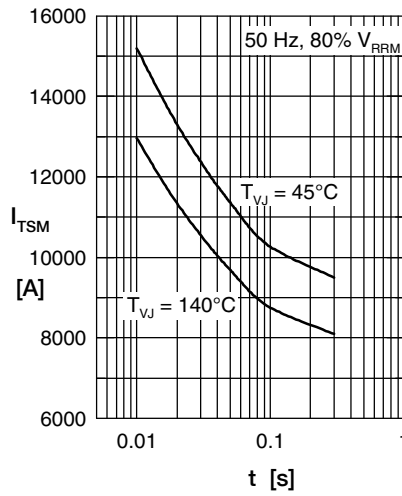

Fig. 2 Surge overload current  $I_{TSM}$ : crest value, t: duration

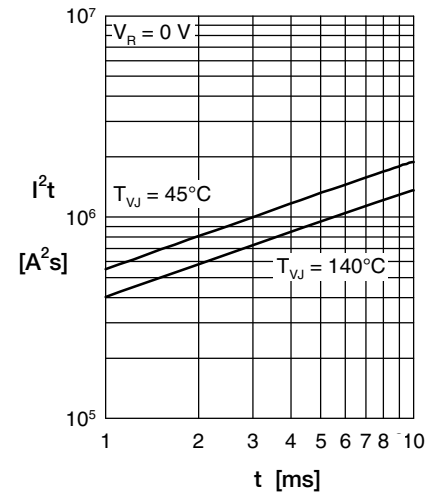

Fig. 3  $I^2t$  versus time (1-10 s)

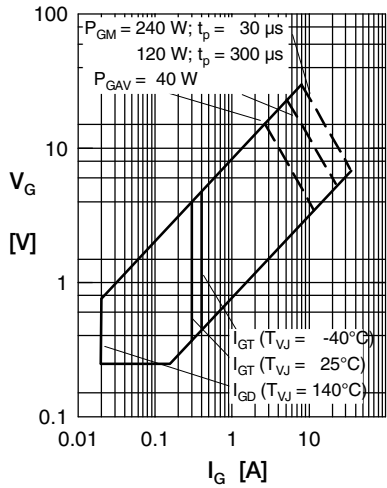

Fig. 4 Gate voltage & gate current

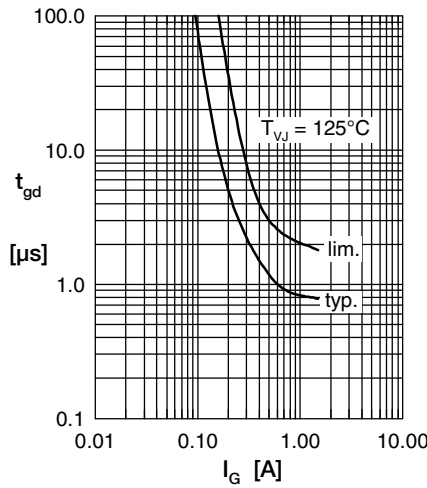

Fig. 5 Gate controlled delay time  $t_{gd}$

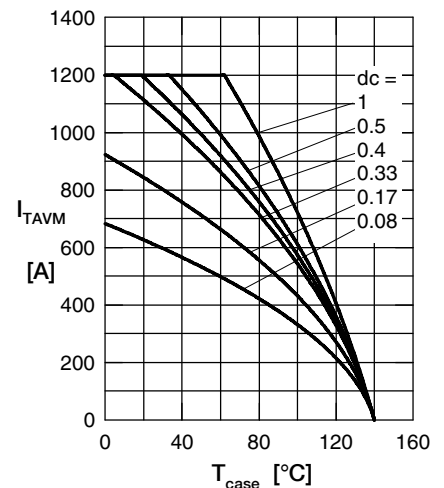

Fig. 6 Max. forward current at case temperature

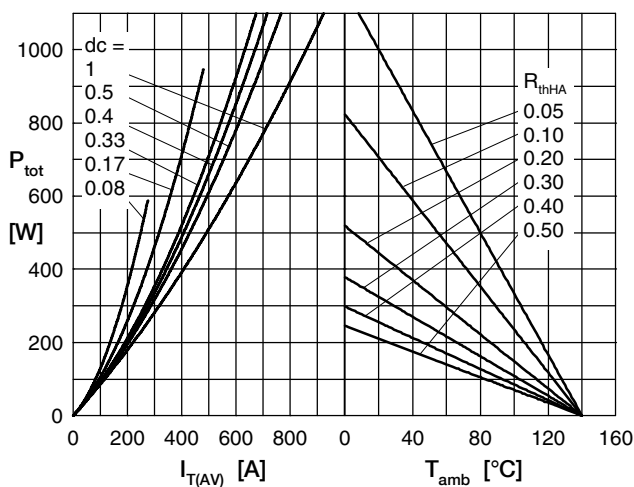

Fig. 7a Power dissipation versus direct output current  
Fig. 7b and ambient temperature

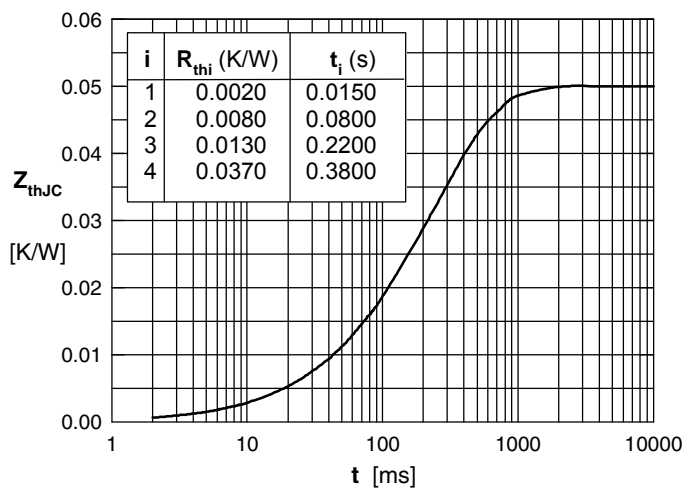

Fig. 8 Transient thermal impedance junction to case