

Converter - Brake - Inverter Module XPT IGBT

Preliminary data

Three Phase Rectifier	Brake Chopper	Three Phase Inverter
$V_{RRM} = 1600 \text{ V}$	$V_{CES} = 1200 \text{ V}$	$V_{CES} = 1200 \text{ V}$
$I_{DAVM25} = 100 \text{ A}$	$I_{C25} = 17 \text{ A}$	$I_{C25} = 17 \text{ A}$
$I_{FSM} = 270 \text{ A}$	$V_{CE(sat)} = 1.8 \text{ V}$	$V_{CE(sat)} = 1.8 \text{ V}$

Part name (Marking on product)

MIXA10WB1200TMH

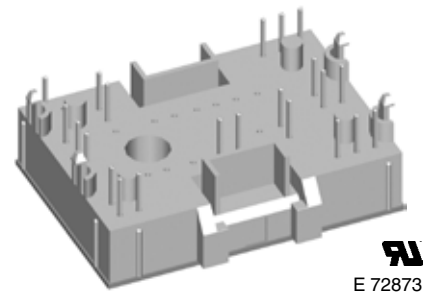
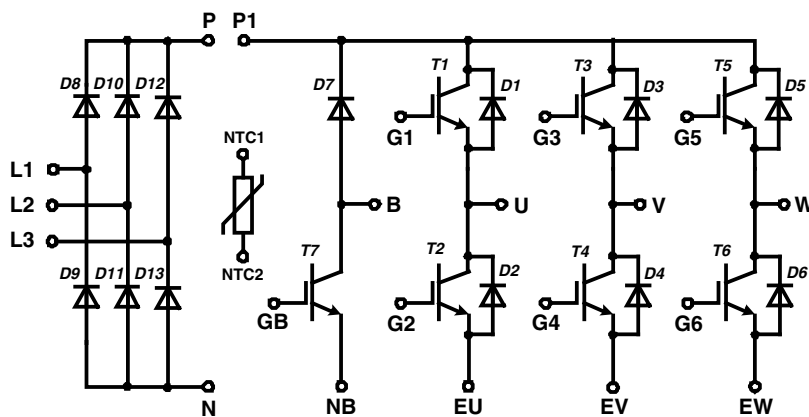

E 72873

Pin configuration see outlines.

Features:

- High level of integration - only one power semiconductor module required for the whole drive
- Rugged XPT design (Xtreme light Punch Through) results in:
 - short circuit rated for 10 μsec .
 - very low gate charge
 - square RBSOA @ $3 \times I_c$
 - low EMI
- Thin wafer technology combined with the XPT design results in a competitive low $V_{CE(sat)}$
- Temperature sense included
- SONIC™ diode
 - fast and soft reverse recovery
 - low operating forward voltage

Application:

- AC motor drives
- Pumps, Fans
- Washing machines
- Air-conditioning system
- Inverter and power supplies

Package:

- "Mini" package
- Assembly height is 17 mm
- Insulated base plate
- Pins suitable for wave soldering and PCB mounting
- Assembly clips available
 - IXKU 5-505 screw clamp
 - IXRB 5-506 click clamp
- UL registered E72873

Output Inverter T1 - T6

Symbol	Definitions	Conditions	Ratings			Unit	
			min.	typ.	max.		
V_{CES}	collector emitter voltage		$T_{VJ} = 25^{\circ}\text{C}$		1200	V	
V_{GES}	max. DC gate voltage	continuous			± 20	V	
V_{GEM}	max. transient collector gate voltage	transient			± 30	V	
I_{C25}	collector current		$T_C = 25^{\circ}\text{C}$		17	A	
I_{C80}			$T_C = 80^{\circ}\text{C}$		12	A	
P_{tot}	total power dissipation		$T_C = 25^{\circ}\text{C}$		63	W	
$V_{CE(sat)}$	collector emitter saturation voltage	$I_C = 9\text{ A}; V_{GE} = 15\text{ V}$	$T_{VJ} = 25^{\circ}\text{C}$ $T_{VJ} = 125^{\circ}\text{C}$	1.8 2.1	2.1	V V	
$V_{GE(th)}$	gate emitter threshold voltage	$I_C = 0.3\text{ mA}; V_{GE} = V_{CE}$	$T_{VJ} = 25^{\circ}\text{C}$	5	5.5	6.5	V
I_{CES}	collector emitter leakage current	$V_{CE} = V_{CES}; V_{GE} = 0\text{ V}$	$T_{VJ} = 25^{\circ}\text{C}$ $T_{VJ} = 125^{\circ}\text{C}$	0.02 0.2	0.1	mA mA	
I_{GES}	gate emitter leakage current	$V_{GE} = \pm 20\text{ V}$			500	nA	
$Q_{G(on)}$	total gate charge	$V_{CE} = 600\text{ V}; V_{GE} = 15\text{ V}; I_C = 10\text{ A}$			27	nC	
$t_{d(on)}$	turn-on delay time	inductive load $V_{CE} = 600\text{ V}; I_C = 10\text{ A}$ $V_{GE} = \pm 15\text{ V}; R_G = 100\ \Omega$	$T_{VJ} = 125^{\circ}\text{C}$		70	ns	
t_r	current rise time				40	ns	
$t_{d(off)}$	turn-off delay time				250	ns	
t_f	current fall time				100	ns	
E_{on}	turn-on energy per pulse				1.1	mJ	
E_{off}	turn-off energy per pulse				1.1	mJ	
RBSOA	reverse bias safe operating area	$V_{GE} = \pm 15\text{ V}; R_G = 100\ \Omega; V_{CEK} = 1200\text{ V}$	$T_{VJ} = 125^{\circ}\text{C}$		30	A	
I_{SC} (SCSOA)	short circuit safe operating area	$V_{CE} = 900\text{ V}; V_{GE} = \pm 15\text{ V};$ $R_G = 100\ \Omega; t_p = 10\ \mu\text{s};$ non-repetitive	$T_{VJ} = 125^{\circ}\text{C}$		40	A	
R_{thJC}	thermal resistance junction to case	(per IGBT)			2	K/W	
R_{thCH}	thermal resistance case to heatsink			0.7		K/W	

Output Inverter D1 - D6

Symbol	Definitions	Conditions	Ratings			Unit
			min.	typ.	max.	
V_{RRM}	max. repetitive reverse voltage		$T_{VJ} = 25^{\circ}\text{C}$		1200	V
I_{F25}	forward current		$T_C = 25^{\circ}\text{C}$		19	A
I_{F80}			$T_C = 80^{\circ}\text{C}$		13	A
V_F	forward voltage	$I_F = 10\text{ A}; V_{GE} = 0\text{ V}$	$T_{VJ} = 25^{\circ}\text{C}$ $T_{VJ} = 125^{\circ}\text{C}$	1.95 1.85	2.2	V V
Q_{rr}	reverse recovery charge	$V_R = 600\text{ V}$ $di_F/dt = -250\text{ A}/\mu\text{s}$ $I_F = 10\text{ A}; V_{GE} = 0\text{ V}$	$T_{VJ} = 125^{\circ}\text{C}$		1.2	μC
I_{RM}	max. reverse recovery current				9	A
t_{rr}	reverse recovery time				320	ns
E_{rec}	reverse recovery energy				0.4	mJ
R_{thJC}	thermal resistance junction to case	(per diode)			2.4	K/W
R_{thCH}	thermal resistance case to heatsink			0.8		K/W

Brake T7

Symbol	Definitions	Conditions	Ratings			Unit
			min.	typ.	max.	
V_{CES}	collector emitter voltage	$T_{VJ} = 25^{\circ}\text{C}$			1200	V
V_{GES}	max. DC gate voltage	continuous			± 20	V
V_{GEM}	max. transient collector gate voltage	transient			± 30	V
I_{C25}	collector current	$T_C = 25^{\circ}\text{C}$			17	A
I_{C80}		$T_C = 80^{\circ}\text{C}$			12	A
P_{tot}	total power dissipation	$T_C = 25^{\circ}\text{C}$			63	W
$V_{CE(sat)}$	collector emitter saturation voltage	$I_C = 9\text{ A}; V_{GE} = 15\text{ V}$			1.8 2.1	V V
$V_{GE(th)}$	gate emitter threshold voltage	$I_C = 0.3\text{ mA}; V_{GE} = V_{CE}$	5	5.5	6.5	V
I_{CES}	collector emitter leakage current	$V_{CE} = V_{CES}; V_{GE} = 0\text{ V}$			0.01 0.1	mA mA
I_{GES}	gate emitter leakage current	$V_{GE} = \pm 20\text{ V}$			500	nA
$Q_{G(on)}$	total gate charge	$V_{CE} = 600\text{ V}; V_{GE} = 15\text{ V}; I_C = 10\text{ A}$			27	nC
$t_{d(on)}$	turn-on delay time	inductive load $V_{CE} = 600\text{ V}; I_C = 10\text{ A}$ $V_{GE} = \pm 15\text{ V}; R_G = 100\ \Omega$	$T_{VJ} = 125^{\circ}\text{C}$		70	ns
t_r	current rise time				40	ns
$t_{d(off)}$	turn-off delay time				250	ns
t_f	current fall time				100	ns
E_{on}	turn-on energy per pulse				1.1	mJ
E_{off}	turn-off energy per pulse				1.1	mJ
RBSOA	reverse bias safe operating area	$V_{GE} = \pm 15\text{ V}; R_G = 100\ \Omega; V_{CEK} = 1200\text{ V}$			30	A
		$T_{VJ} = 125^{\circ}\text{C}$				
I_{SC} (SCSOA)	short circuit safe operating area	$V_{CE} = 900\text{ V}; V_{GE} = \pm 15\text{ V};$ $R_G = 100\ \Omega; t_p = 10\ \mu\text{s};$ non-repetitive			40	A
R_{thJC}	thermal resistance junction to case	(per IGBT)			2	K/W
R_{thCH}	thermal resistance case to heatsink				0.7	K/W

Brake Chopper D7

Symbol	Definitions	Conditions	Ratings			Unit
			min.	typ.	max.	
V_{RRM}	max. repetitive reverse voltage	$T_{VJ} = 150^{\circ}\text{C}$			1200	V
I_{F25}	forward current	$T_C = 25^{\circ}\text{C}$			12	A
I_{F80}		$T_C = 80^{\circ}\text{C}$			8	A
V_F	forward voltage	$I_F = 5\text{ A}; V_{GE} = 0\text{ V}$			1.95 1.85	V V
I_R	reverse current	$V_R = V_{RRM}$			0.01 0.1	mA mA
Q_{rr}	reverse recovery charge	$V_R = 600\text{ V}$ $di_F/dt = 200\text{ A}/\mu\text{s}$ $I_F = 5\text{ A}; V_{GE} = 0\text{ V}$	$T_{VJ} = 125^{\circ}\text{C}$		0.7	μC
I_{RM}	max. reverse recovery current				6	A
t_{rr}	reverse recovery time				320	ns
E_{rec}	reverse recovery energy				0.2	mJ
R_{thJC}	thermal resistance junction to case	(per diode)			3.4	K/W
R_{thCH}	thermal resistance case to heatsink				1.1	K/W

Input Rectifier Bridge D8 - D11

Symbol	Definitions	Conditions	Ratings			Unit
			min.	typ.	max.	
V_{RRM}	max. repetitive reverse voltage		$T_{VJ} = 25^{\circ}\text{C}$		1600	V
I_{FAV}	average forward current	sine 180°	$T_C = 80^{\circ}\text{C}$		24	A
I_{DAVM}	max. average DC output current	rect.; $d = 1/3$	$T_C = 80^{\circ}\text{C}$		69	A
I_{FSM}	max. forward surge current	$t = 10$ ms; sine 50 Hz	$T_{VJ} = 25^{\circ}\text{C}$ $T_{VJ} = 125^{\circ}\text{C}$		270 240	A A
I^2t	I^2t value for fusing	$t = 10$ ms; sine 50 Hz	$T_{VJ} = 25^{\circ}\text{C}$ $T_{VJ} = 125^{\circ}\text{C}$		360 290	A^2s A^2s
P_{tot}	total power dissipation		$T_C = 25^{\circ}\text{C}$		69	W
V_F	forward voltage	$I_F = 30$ A	$T_{VJ} = 25^{\circ}\text{C}$ $T_{VJ} = 125^{\circ}\text{C}$	1.27 1.24	1.6	V V
I_R	reverse current	$V_R = V_{RRM}$	$T_{VJ} = 25^{\circ}\text{C}$ $T_{VJ} = 125^{\circ}\text{C}$	0.3	0.01	mA mA
R_{thJC}	thermal resistance junction to case	(per diode)			1.8	K/W
R_{thCH}	thermal resistance case to heatsink	(per diode)		0.6		K/W

Temperature Sensor NTC

Symbol	Definitions	Conditions	Ratings			Unit	
			min.	typ.	max.		
R_{25}	resistance		$T_C = 25^{\circ}\text{C}$	4.75	5.0	5.25	$\text{k}\Omega$
$B_{25/50}$					3375		K

Module

Symbol	Definitions	Conditions	Ratings			Unit
			min.	typ.	max.	
T_{VJ}	operating temperature		-40		125	$^{\circ}\text{C}$
T_{VJM}	max. virtual junction temperature				150	$^{\circ}\text{C}$
T_{stg}	storage temperature		-40		125	$^{\circ}\text{C}$
V_{ISOL}	isolation voltage	$I_{ISOL} \leq 1$ mA; 50/60 Hz			2500	V~
CTI	comparative tracking index				-	
F_C	mounting force		40		80	N
d_S	creep distance on surface		12.7			mm
d_A	strike distance through air		12			mm
Weight				35		g

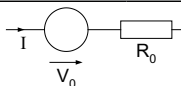
Equivalent Circuits for Simulation

Symbol	Definitions	Conditions	Ratings			Unit
			min.	typ.	max.	
V_0	rectifier diode	D8 - D13	$T_{VJ} = 150^{\circ}\text{C}$		0.86	V
R_0					12.3	$\text{m}\Omega$
V_0	IGBT	T1 - T6	$T_{VJ} = 150^{\circ}\text{C}$		1.1	V
R_0					153	$\text{m}\Omega$
V_0	free wheeling diode	D1 - D6	$T_{VJ} = 150^{\circ}\text{C}$		1.09	V
R_0					91	$\text{m}\Omega$
V_0	IGBT	T7	$T_{VJ} = 150^{\circ}\text{C}$		1.1	V
R_0					153	$\text{m}\Omega$
V_0	free wheeling diode	D7	$T_{VJ} = 150^{\circ}\text{C}$		1.15	V
R_0					171	$\text{m}\Omega$

IXYS reserves the right to change limits, test conditions and dimensions.

 $T_C = 25^{\circ}\text{C}$ unless otherwise stated

20110916b

Circuit Diagram

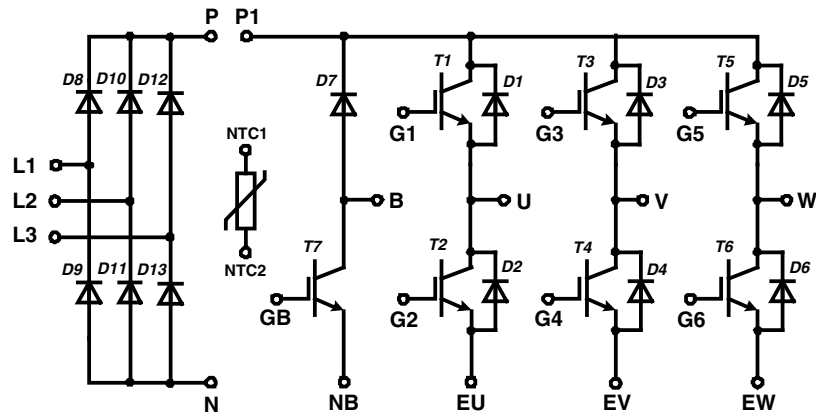

Outline Drawing

Dimensions in mm (1 mm = 0.0394")

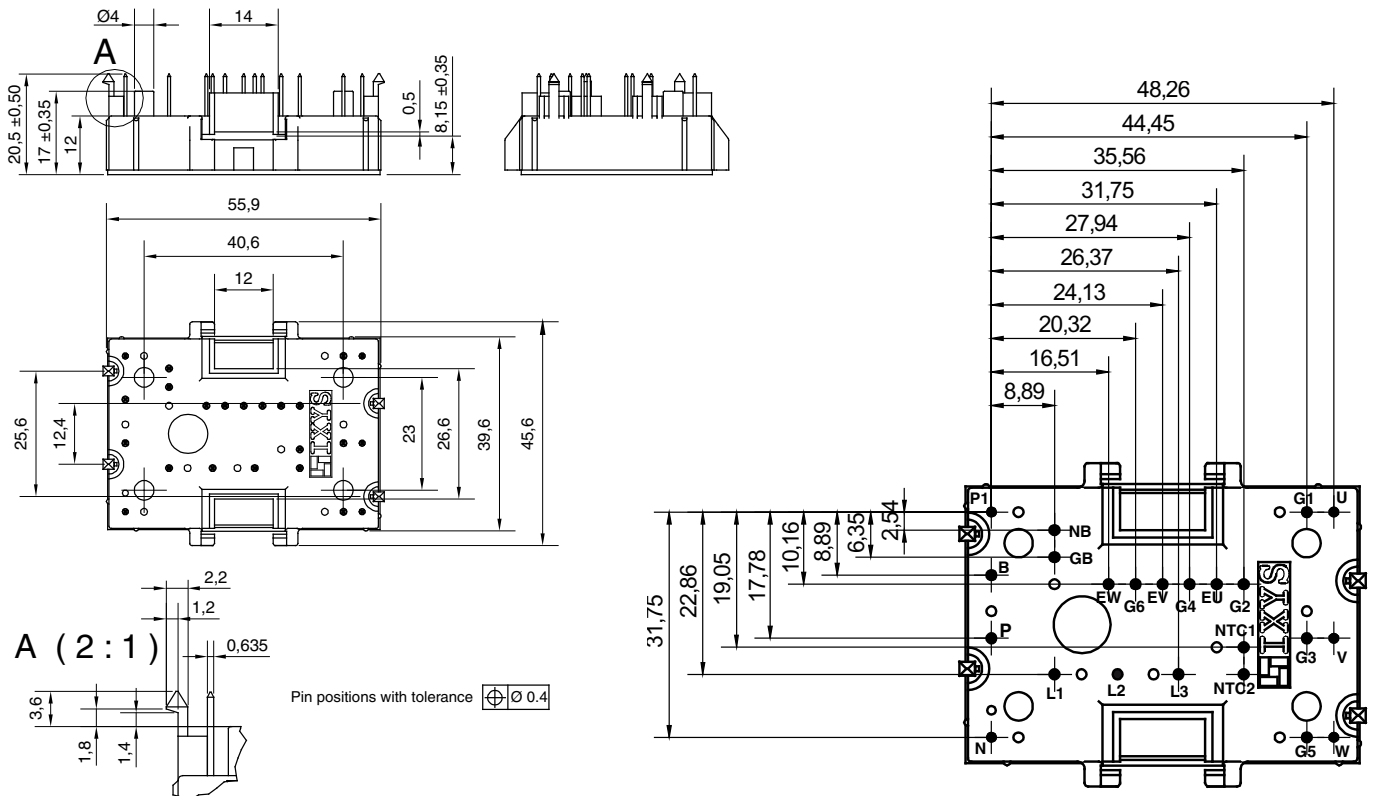

Product Marking

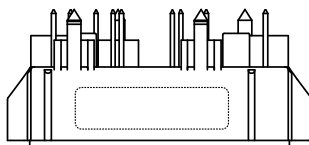

Part number

- M = Module
- I = IGBT
- X = XPT
- A = standard
- 20 = Current Rating [A]
- WB = 6-Pack + 3~ Rectifier Bridge & Brake Unit
- 1200 = Reverse Voltage [V]
- T = NTC
- MH = MiniPack2

Ordering	Part Name	Marking on Product	Delivering Mode	Base Qty	Ordering Code
Standard	MIXA 10 WB 1200 TMH	MIXA10WB1200TMH	Box	20	508609

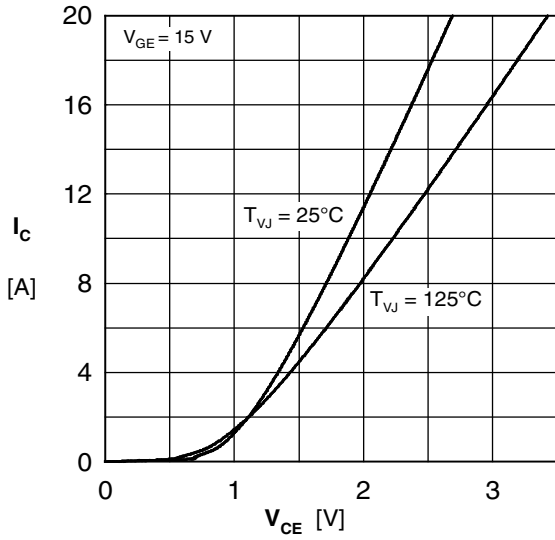

Fig. 1 Typ. output characteristics

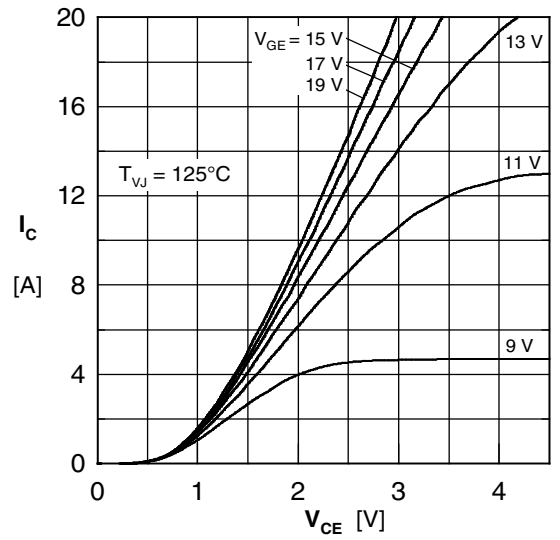

Fig. 2 Typ. output characteristics

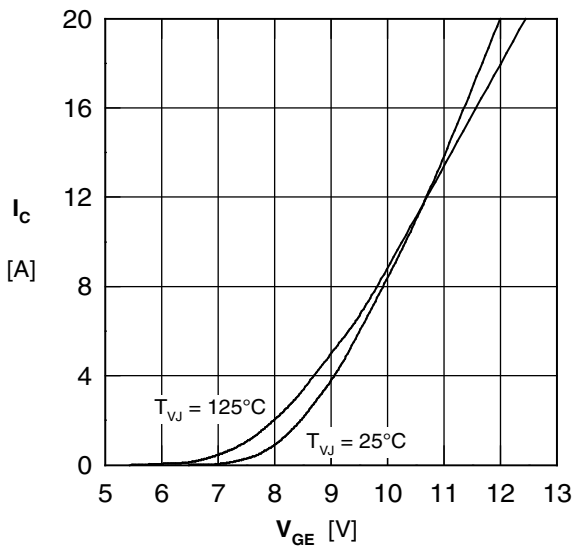

Fig. 3 Typ. transfer characteristics

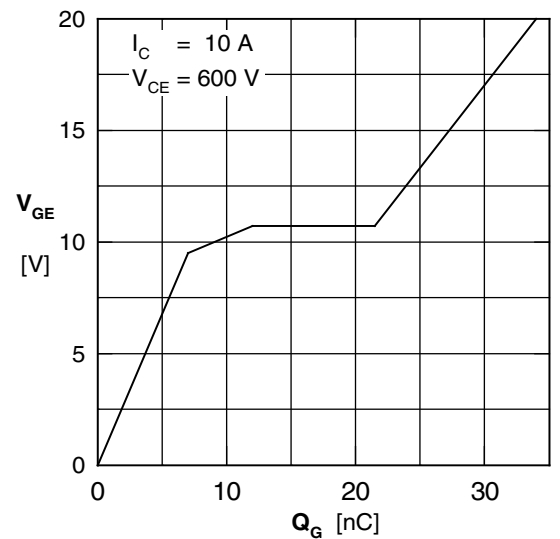

Fig. 4 Typ. turn-on gate charge

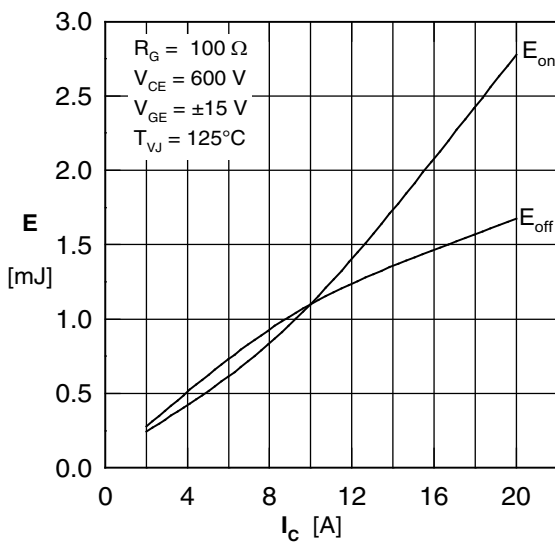

Fig. 5 Typ. switching energy vs. collector current

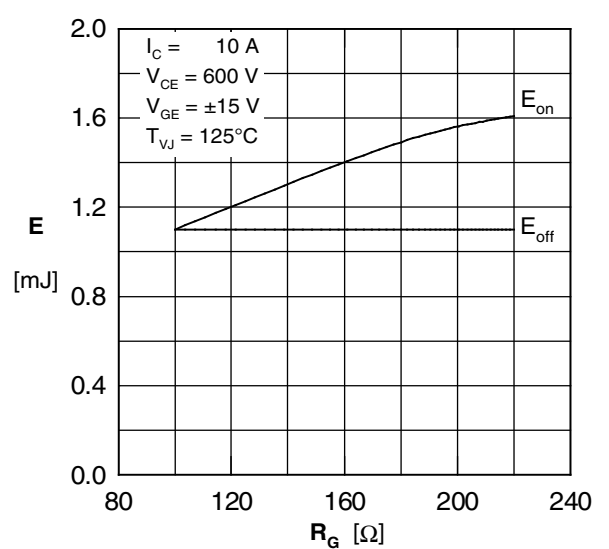

Fig. 6 Typ. switching energy vs. gate resistance

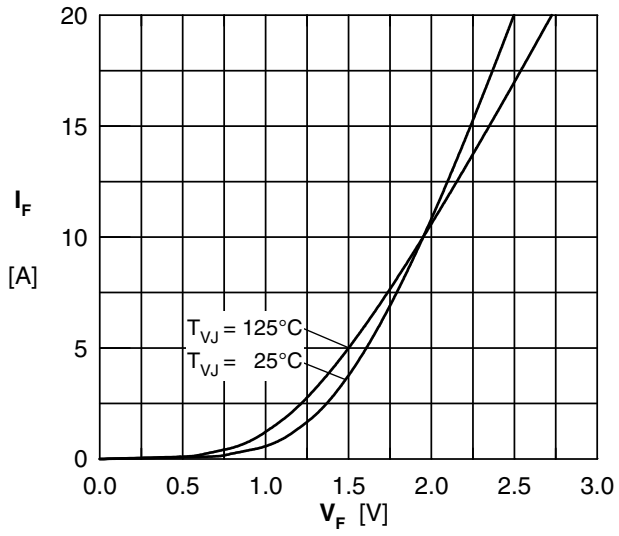

Fig. 7 Typ. forward characteristics

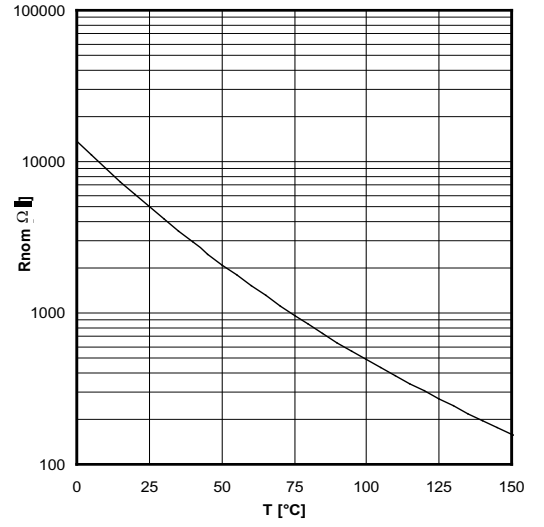

Fig. 8 Typ. thermistor resistance vs. temperature

Mouser Electronics

Authorized Distributor

Click to View Pricing, Inventory, Delivery & Lifecycle Information:

[IXYS:](#)

[MIXA10WB1200TMH](#)