

IGBT Modules

H-Bridge

Trench IGBT

$I_{C25} = 89\text{ A}$
 $V_{CES} = 600\text{ V}$
 $V_{CE(sat) \text{ typ.}} = 1.8\text{ V}$

Preliminary data

Part name (Marking on product)

MKI 80-06T6K

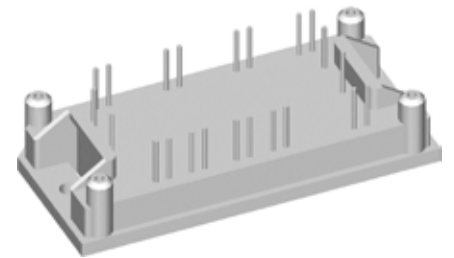
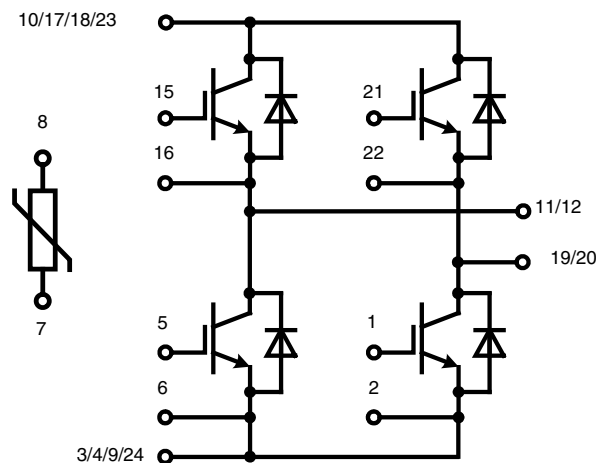

Features:

- Trench IGBT technology
- Low saturation voltage
- Low switching losses
- Square RBSOA, no latch up
- High short circuit capability
- Positive temperature coefficient for easy parallelling
- MOS input, voltage controlled
- Ultra fast free wheeling diodes
- Solderable pins for PCB mounting
- Space saving
- Reduced protection circuits

Application:

- AC motor control
- AC servo and robot drives
- Power supplies

Package:

- Industry standard E1-pack
- Designed for wave soldering
- With copper base plate

IGBTs						
Symbol	Definitions	Conditions	Ratings			Unit
			min.	typ.	max.	
V_{CES}	collector emitter voltage	$T_{VJ} = 25^{\circ}\text{C to } 150^{\circ}\text{C}$			600	V
V_{GES}	max. DC gate voltage	continuous			± 20	V
V_{GEM}	max. transient collector gate voltage	transient			± 30	V
I_{C25}	collector current	$T_C = 25^{\circ}\text{C}$			89	A
I_{C80}		$T_C = 80^{\circ}\text{C}$			67	A
P_{tot}	total power dissipation	$T_C = 25^{\circ}\text{C}$			210	W
$V_{CE(sat)}$	collector emitter saturation voltage	$I_C = 75\text{ A}; V_{GE} = 15\text{ V}$			1.8 2.3	V V
$V_{GE(th)}$	gate emitter threshold voltage	$I_C = 1.2\text{ mA}; V_{GE} = V_{CE}$	5		6.5	V
I_{CES}	collector emitter leakage current	$V_{CE} = V_{CES}; V_{GE} = 0\text{ V}$			0.5	mA mA
I_{GES}	gate emitter leakage current	$V_{CE} = 0\text{ V}; V_{GE} = \pm 20\text{ V}$			400	nA
C_{ies}	input capacitance	$V_{CE} = 25\text{ V}; V_{GE} = 0\text{ V}; f = 1\text{ MHz}$			4620	pF
$Q_{G(on)}$	total gate charge	$V_{CE} = 480\text{ V}; V_{GE} = 15\text{ V}; I_C = 75\text{ A}$			470	nC
$t_{d(on)}$	turn-on delay time	inductive load $V_{CE} = 300\text{ V}; I_C = 75\text{ A}$ $V_{GE} = \pm 15\text{ V}; R_G = 5.1\ \Omega$				ns
t_r	current rise time					
$t_{d(off)}$	turn-off delay time					
t_f	current fall time					
E_{on}	turn-on energy per pulse					
E_{off}	turn-off energy per pulse					
I_{CM}	reverse bias safe operating area	RBSOA; $V_{GE} = \pm 15\text{ V}; R_G = 5.1\ \Omega; L = 100\ \mu\text{H}$			150	A
V_{CEK}		clamped inductive load; $T_{VJ} = 125^{\circ}\text{C}$			0.9x	V_{CES}
t_{SC} (SCSOA)	short circuit safe operating area	$V_{CE} = 480\text{ V}; V_{GE} = \pm 15\text{ V}; R_G = 5.1\ \Omega; \text{non-repetitive}$			6	μs
R_{thJC}	thermal resistance junction to case	(per IGBT)			0.6	K/W
R_{thCH}	thermal resistance case to heatsink	(per IGBT)			0.2	K/W

Diodes						
Symbol	Definitions	Conditions	Maximum Ratings			Unit
			min.	typ.	max.	
V_{RRM}	max. repetitive reverse voltage				600	V
I_{F25}	forward current	$T_C = 25^{\circ}\text{C}$			105	A
I_{F80}		$T_C = 80^{\circ}\text{C}$			67	A
Symbol	Conditions	Characteristic Values				Unit
		min.	typ.	max.		
V_F	forward voltage	$I_F = 75\text{ A}$	$T_{VJ} = 25^{\circ}\text{C}$ $T_{VJ} = 125^{\circ}\text{C}$	1.8 1.6	2.2	V V
I_{RM}	max. reverse recovery current	$V_R = 300\text{ V}; I_F = 75\text{ A}$ $di_F/dt = -600\text{ A}/\mu\text{s}$	$T_{VJ} = 100^{\circ}\text{C}$	36		A
t_{rr}	reverse recovery time			100		ns
R_{thJC}	thermal resistance junction to case	(per diode)	$T_{VJ} = 25^{\circ}\text{C}$		0.65	K/W
R_{thCH}	thermal resistance case to heatsink	(per diode)		0.25		K/W

Temperature Sensor NTC

Symbol	Definitions	Conditions	Ratings			Unit
			min.	typ.	max.	
R_{25}	<i>resistance</i>	$T_C = 25^\circ\text{C}$	4.45	4.7	5.0	$\text{k}\Omega$
$B_{25/85}$				3510		K

Module

Symbol	Definitions	Conditions	Ratings			Unit
			min.	typ.	max.	
T_{VJ}	<i>operating temperature</i>		-40		125	$^\circ\text{C}$
T_{VJM}	<i>max. virtual junction temperature</i>				175	$^\circ\text{C}$
T_{stg}	<i>storage temperature</i>		-40		125	$^\circ\text{C}$
V_{ISOL}	<i>isolation voltage</i>	$I_{ISOL} \leq 1 \text{ mA}; 50/60 \text{ Hz}$			2500	V~
M_d	<i>mounting torque</i>	(M4)	2.0		2.2	Nm
d_s	<i>creep distance on surface</i>		12.7			mm
d_A	<i>strike distance through air</i>		12.7			mm
Weight				40		g

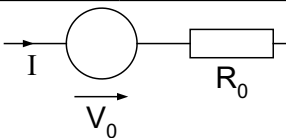
Equivalent Circuits for Simulation

Ratings

Symbol	Definitions	Conditions	min.	typ.	max.	Unit
V_0	<i>IGBT</i>	$T_{VJ} = 125^\circ\text{C}$		0.9		V
R_0				14.3		$\text{m}\Omega$
V_0	<i>free wheeling diode</i>	$T_{VJ} = 125^\circ\text{C}$		1.25		V
R_0				3		$\text{m}\Omega$

Outline Drawing

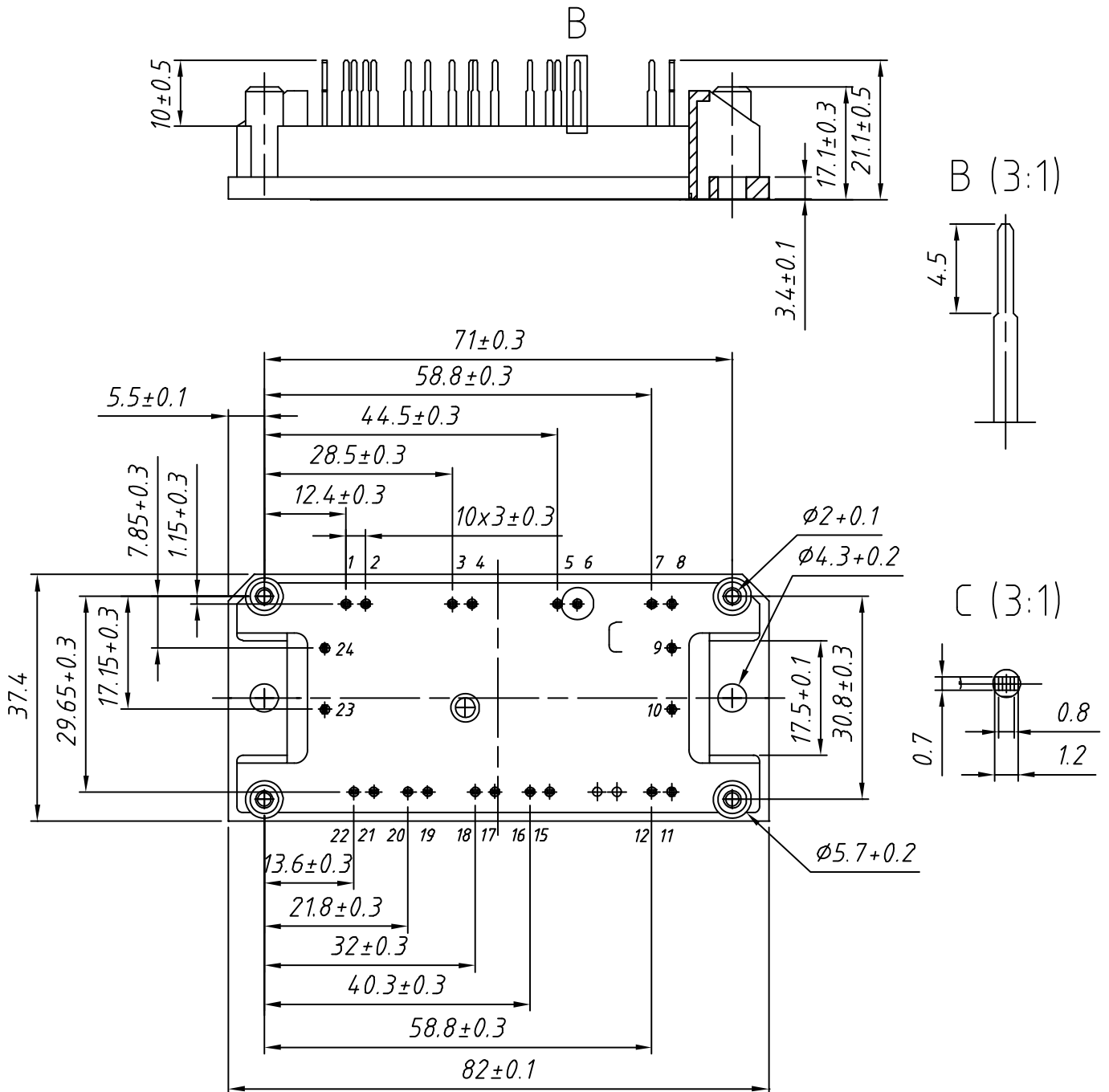
Dimensions in mm (1 mm = 0.0394")



Product Marking

Ordering	Part Name	Marking on Product	Delivering Mode	Base Qty	Ordering Code
Standard	MKI 80-06T6K	MKI80-06T6K	Box	10	504061

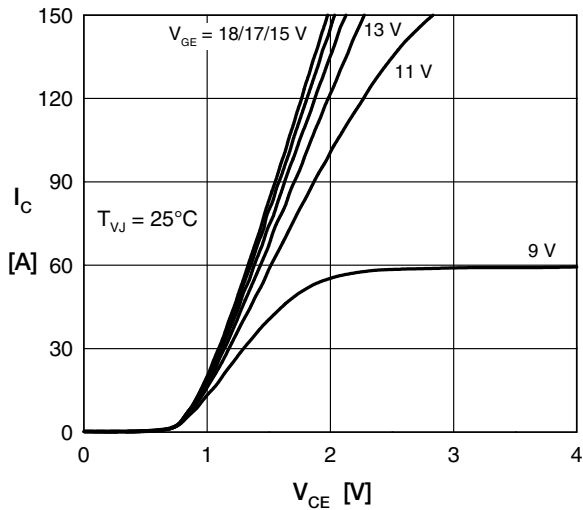

Fig. 1 Typical output characteristics

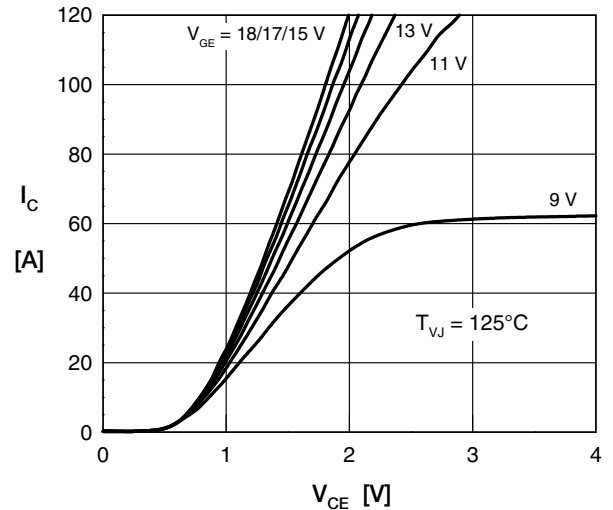

Fig. 2 Typical output characteristics

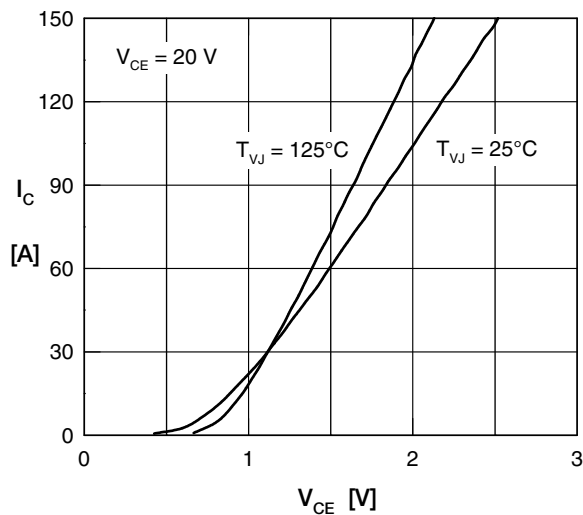

Fig. 3 Typical output characteristics

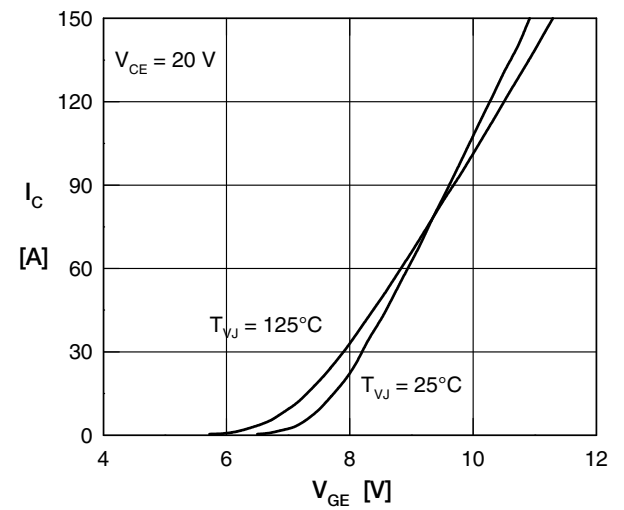

Fig. 4 Typical transfer characteristics

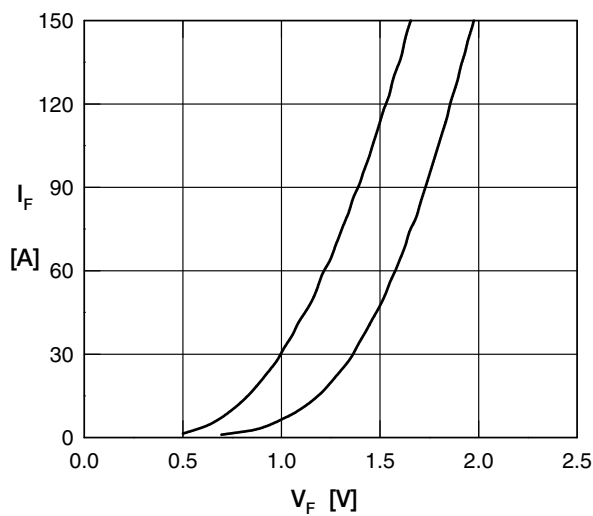

Fig. 5 Typical forward characteristics FWD

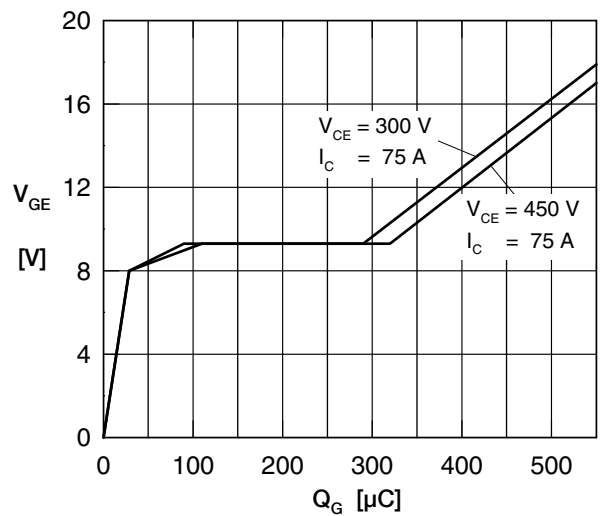

Fig. 6 Typical turn-on gate charge

Mouser Electronics

Authorized Distributor

Click to View Pricing, Inventory, Delivery & Lifecycle Information:

[IXYS:](#)

[MK180-06T6K](#)