

Powerex, Inc., Hillis Street, Youngwood, Pennsylvania 15697 (412) 925-7272
 Powerex, Europe, S.A. 428 Avenue G. Durand, BP107, 72003 Le Mans, France (43) 41.14.14

Intellimod™-3 Modules
 Three Phase
 IGBT Inverter Output
 10 Amperes/110-230 Volt Line

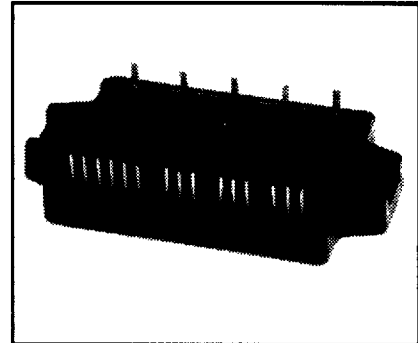
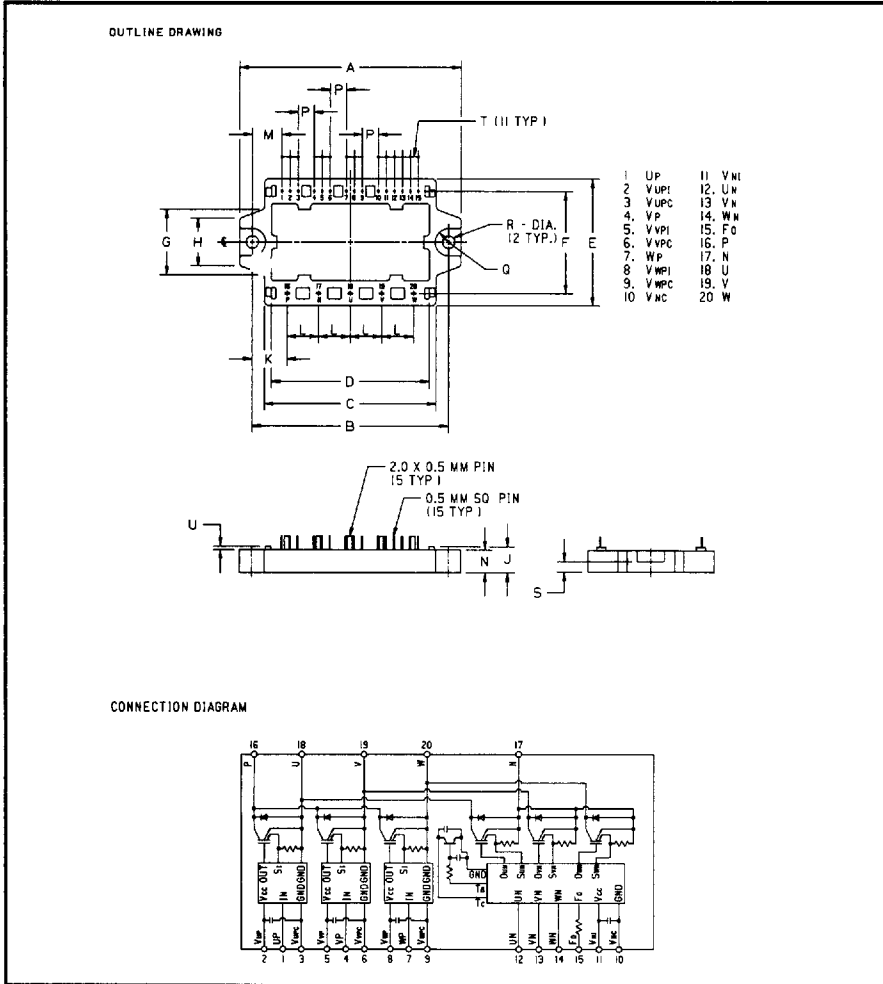

Description

Powerex Intellimod-3 Modules are designed for applications requiring a high frequency (20kHz) output switching inverter. The modules are isolated from the baseplate, consisting of complete drive, control and protection circuitry for the IGBT inverter.

Features:

- Complete Output Power Circuit
- Gate Drive Circuit
- Protection Logic
 - Short Circuit
 - Over-Current
 - Over Temperature
 - Under Voltage

Applications:

- Inverters
- Small UPS
- Motion/Servo Control
- AC Motor Control

Ordering Information
 PM10CHA060

110-230 Volt Line, PM10CHA060 Outline Drawing

| Dimensions | Inches | Millimeters |
|------------|-----------|-------------|
| A | 3.86±0.04 | 98.0±1.0 |
| B | 3.42±0.02 | 87.0±0.5 |
| C | 2.99 | 76.0 |
| D | 2.76 | 70.0 |
| E | 2.20±0.04 | 56.0±1.0 |
| F | 1.77 | 45.0 |
| G | 1.14 | 29.0 |
| H | 0.83 | 21.0 |
| J | 0.63 | 16.0 |
| K | 0.61 | 15.5 |

| Dimensions | Inches | Millimeters |
|------------|-----------|-------------|
| L | 0.55 | 14.0 |
| M | 0.521 | 13.24 |
| N | 0.39 | 10.0 |
| P | 0.28 | 7.12 |
| Q | 0.24R | 6.0R |
| R | 0.22 Dia. | 5.5 Dia |
| S | 0.20 | 5.0 |
| T | 0.14 | 3.56 |
| U | 0.06 | 1.5V |



POWEREX INC

51E D ■ 7294621 0005644 576 ■ PRX

Powerex, Inc., Hillis Street, Youngwood, Pennsylvania 15697 (412) 925-7272
 Powerex, Europe, S.A. 428 Avenue G. Durand, BP107, 72003 Le Mans, France (43) 41.14.14

T-57-29

PM10CHA060
 Intellimod-3 Modules
 Three Phase IGBT Inverter Output
 10 Amperes/110-230 Volt Line

Electrical Characteristics, $T_j = 25^\circ\text{C}$ unless otherwise specified

| Characteristics | Symbol | Test Conditions | Min. | Typ. | Max. | Units |
|---|----------------|--|------|------|------|------------------|
| Control Sector | | | | | | |
| Overcurrent Trip Level Inverter Part | OC | $-20^\circ\text{C} \leq T \leq 125^\circ\text{C}$ | 12 | 18 | – | Amperes |
| Short Circuit Trip Level Inverter Part | SC | $-20^\circ\text{C} \leq T \leq 125^\circ\text{C}$ | – | 27 | – | Amperes |
| Overcurrent Delay Time | $t_{off(OC)}$ | $V_D = 15\text{V}$ Fig. 7 | – | 10 | – | μS |
| Over Temperature Protection | OT | Trip Level | 100 | 110 | 120 | $^\circ\text{C}$ |
| Over Temperature Protection | OT_R | Reset Level | – | 90 | – | $^\circ\text{C}$ |
| Supply Circuit Under Voltage Protection | UV | Trip Level | 11.5 | 12.0 | 12.5 | Volts |
| Supply Circuit Under Voltage Protection | UV_R | Reset Level | – | 12.5 | – | Volts |
| Supply Voltage | V_D | Applied between $V_{UP1} - V_{UPC}$, $V_{VP1} - V_{VPC}$, $V_{WP1} - V_{WPC}$, $V_{N1} - V_{NC}$ | 13.5 | 15 | 16.5 | Volts |
| Circuit Current | I_D | $V_D = 15\text{V}$, $I_{CIN} = 1\text{mA}$, $V_{N1} - V_{NC}$ | – | 25 | 40 | mA |
| | I_D | $V_D = 15\text{V}$, $I_{CIN} = 1\text{mA}$, $V_{XP1} - V_{XPC}$ | – | 7 | 12 | mA |
| Input Bias On Current | $I_{CIN(on)}$ | Sink Current at $U_P, V_P, W_P, U_N, V_N, W_N$ | 0.1 | 0.22 | 0.5 | mA |
| Input Bias Off Current | $I_{CIN(off)}$ | Sink current at $U_P, V_P, W_P, U_N, V_N, W_N$ | 0.1 | 0.22 | 0.5 | mA |
| PWM Input Frequency | f_{PWM} | 3- \emptyset Sinusoidal | – | 15 | 20 | kHz |
| Dead Time | t_{DEAD} | For each Input Pulse | 2.0 | – | – | μS |
| | | Using example Interface Circuit* | 5.0 | – | – | μS |
| Fault Output Current | $I_{FO(H)}$ | $V_D = 15\text{V}$, $V_{FO} = 15\text{V}$ | – | – | 0.01 | mA |
| | $I_{FO(L)}$ | $V_D = 15\text{V}$, $V_{FO} = 15\text{V}$ | – | 10 | 15 | mA |
| Minimum Fault Output Pulse Width | t_{FO} | $V_D = 15\text{V}$ | 20 | 40 | 60 | μS |
| | | Using example Interface Circuit* $V_D = 15\text{V}$ | 25 | 100 | – | μS |

*See Intellimod-3 Applications Data Section 4.3.



POWEREX INC

51E D ■ 729462J 0005645 402 ■ PRX

Powerex, Inc., Hillis Street, Youngwood, Pennsylvania 15697 (412) 925-7272

Powerex, Europe, S.A. 428 Avenue G. Durand, BP107, 72003 Le Mans, France (43) 41.14.14

PM10CHA060

Intellimod-3 Modules

Three Phase IGBT Inverter Output

10 Amperes/110-230 Volt Line

T-57-29

Electrical Characteristics, $T_j = 25\text{ }^\circ\text{C}$ unless otherwise specified

| Characteristics | Symbol | Test Conditions | Min. | Typ. | Max. | Units |
|--------------------------------------|---------------|--|------|------|------|---------------|
| IGBT Inverter Sector | | | | | | |
| Collector Cutoff Current | I_{CEX} | $V_{CE} = V_{CEX}$, $T_j = 25\text{ }^\circ\text{C}$, Fig. 6 | – | – | 1 | mA |
| Collector Cutoff Current | I_{CEX} | $V_{CE} = V_{CEX}$, $T_j = 125\text{ }^\circ\text{C}$, Fig. 6 | – | – | 10 | mA |
| Diode Forward Voltage | V_{FM} | $-I_C = 10\text{A}$, $V_D = 15\text{V}$, $I_{CIN} = 1\text{mA}$, Fig. 3 | – | 1.5 | 2.5 | Volts |
| Collector Emitter Saturation Voltage | $V_{CE(sat)}$ | $V_D = 15\text{V}$, $I_{CIN} = 0\text{mA}$, $I_C = 10\text{A}$, Fig. 2 | – | 2.6 | 3.5 | Volts |
| Collector Emitter Saturation Voltage | $V_{CE(sat)}$ | $V_D = 15\text{V}$, $I_{CIN} = 0\text{mA}$, $I_C = 10\text{A}$, $T_j = 125\text{ }^\circ\text{C}$, Fig. 2 | – | 2.5 | 3.4 | Volts |
| Inductive Load Switching Times | t_{on} | $V_D = 15\text{V}$, $I_{CIN} = 0\text{mA}$, | 0.5 | 0.8 | 1.5 | μS |
| | t_{rr} | $V_{CC} = 300\text{V}$, $I_C = 10\text{A}$, | – | 0.15 | 0.4 | μS |
| | $t_{C(on)}$ | $T_j = 125\text{ }^\circ\text{C}$, | – | 0.3 | 1.0 | μS |
| | t_{off} | Fig. 4, Fig. 5 | – | 1.1 | 2.5 | μS |
| | $t_{C(off)}$ | | – | 0.5 | 1.5 | μS |

Thermal Characteristics

| Characteristics | Symbol | Test Conditions | Min. | Typ. | Max. | Units |
|--------------------------------------|----------------|-------------------------------------|------|------|------|--------------------|
| Junction to Case Thermal Resistances | $R_{th(l-c)Q}$ | Inverter IGBT Part | – | – | 3.2 | $^\circ\text{C/W}$ |
| | $R_{th(l-c)F}$ | Inverter FWD | – | – | 4.5 | $^\circ\text{C/W}$ |
| Contact Thermal Resistance | $R_{th(c-f)}$ | Case to Fin, Thermal Grease Applied | – | – | 0.4 | $^\circ\text{C/W}$ |

Recommended Operating Conditions

| Characteristics | Symbol | Test Conditions | Value | Units |
|---------------------|----------------|--|--------------|---------------|
| Supply Voltage | V_{CC} | Applied across P-N Terminals | 0 ~ 400 | Volts |
| | V_D | Applied between $V_{UP1} - V_{UPC}$, $V_{N1} - V_{NC}$, $V_{VP1} - V_{VPC}$, $V_{WP1} - V_{WPC}$ | 15 ± 1.5 | Volts |
| Input On Current | $I_{CIN(on)}$ | Applied between | 0 ~ 0.5 | mA |
| Input Off Current | $I_{CIN(off)}$ | $U_P, V_P, W_P, U_N, V_N, W_N$ | 0.5 ~ 2 | mA |
| PWM Input Frequency | f_{PWM} | Using example Interface Circuit* | 5 ~ 20 | kHz |
| Minimum Dead Time | t_{DEAD} | Using example Interface Circuit* | 5.0 | μS |

See Intellimod-3 Applications Data Section 4.3.

T-57-29

PM10CHA060
 Intellimod-3 Modules
 Three Phase IGBT Inverter Output
 10Amperes/110-230 Volt Line

SATURATION VOLTAGE CHARACTERISTICS (TYPICAL)

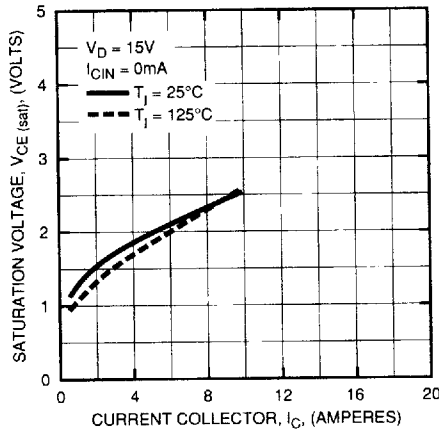

COLLECTOR-EMITTER SATURATION VOLTAGE (TYPICAL)

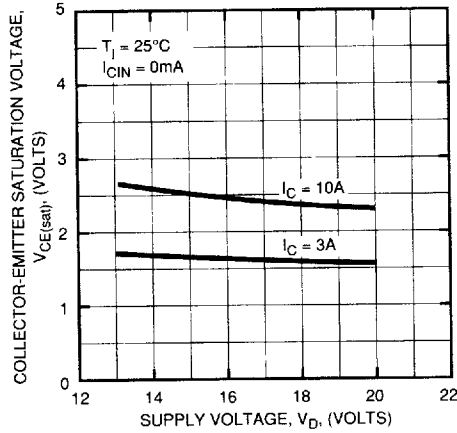

OUTPUT CHARACTERISTICS (TYPICAL)

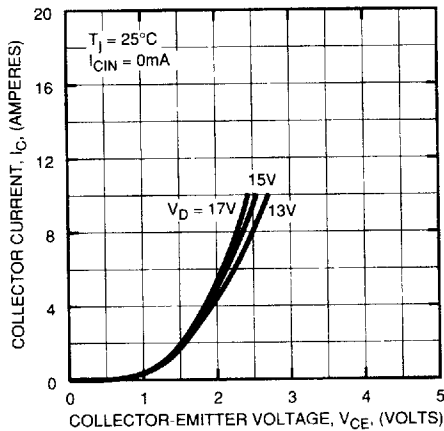

SWITCHING TIME VS. COLLECTOR CURRENT (TYPICAL)

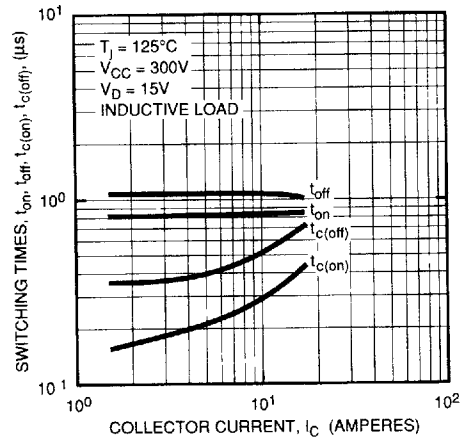

REVERSE RECOVERY CHARACTERISTICS OF FREE-WHEEL DIODE (TYPICAL)

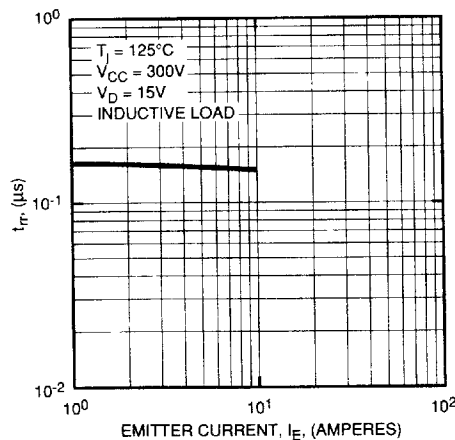

REVERSE COLLECTOR CURRENT VS. EMITTER-COLLECTOR VOLTAGE (DIODE FORWARD CHARACTERISTICS) (TYPICAL)

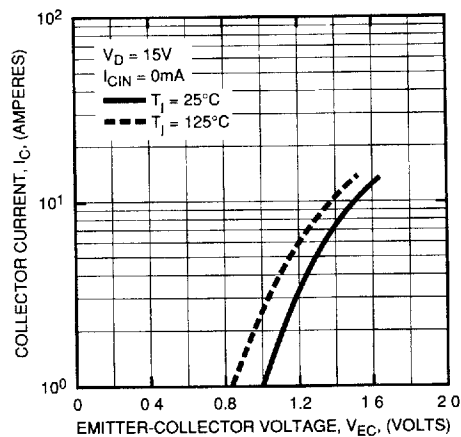

PM10CHA060
Intellimod-3 Modules
Three Phase IGBT Inverter Output
 10 Amperes/110-230 Volt Line

T-57-29

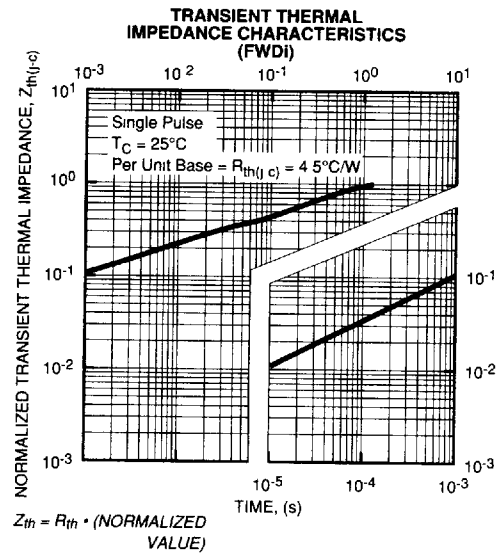
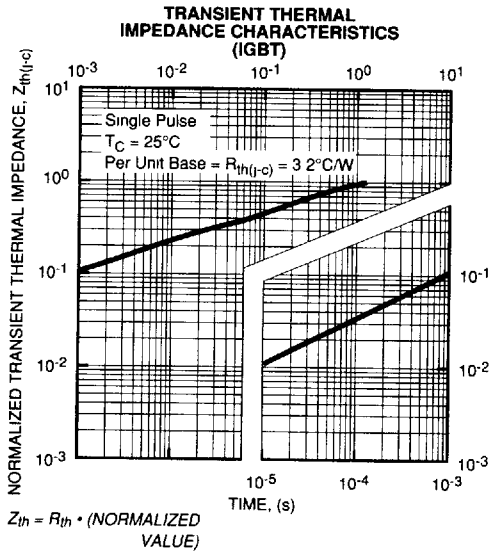
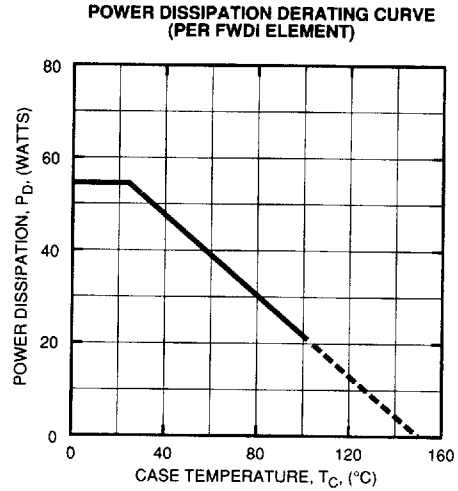
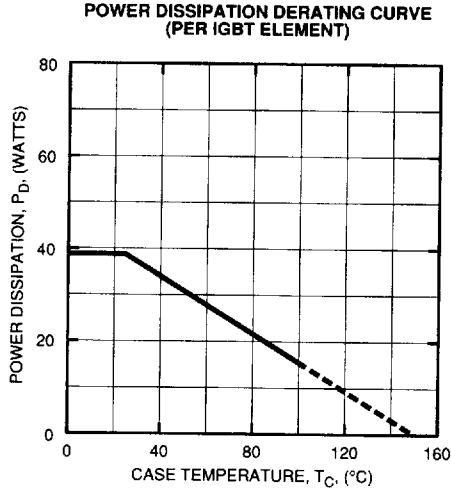

T-57-29

PM10CHA060
Intellimod-3 Modules
Three Phase IGBT Inverter Output
 10 Amperes/110-230 Volt Line

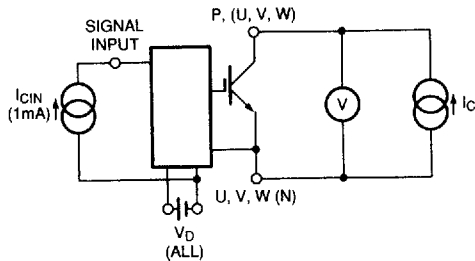

Figure 1 V_{CES} Test

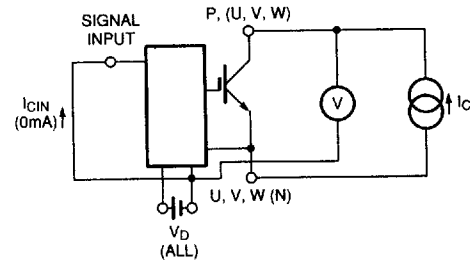

Figure 2 $V_{CE(SAT)}$ Test

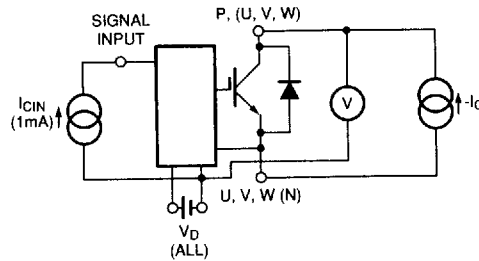
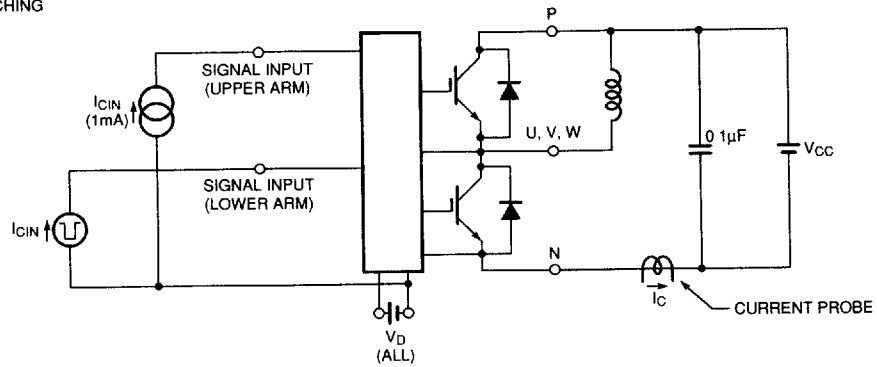

Figure 3 V_{EC} Test

A) LOWER ARM SWITCHING



B) UPPER ARM SWITCHING

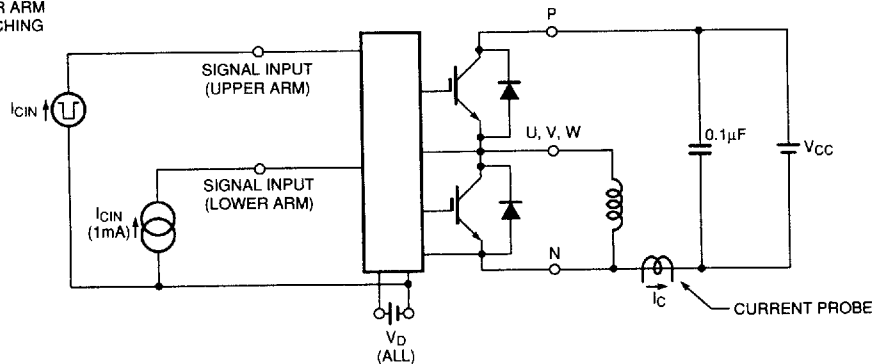

Figure 4 Switching Time Test

T-57-29

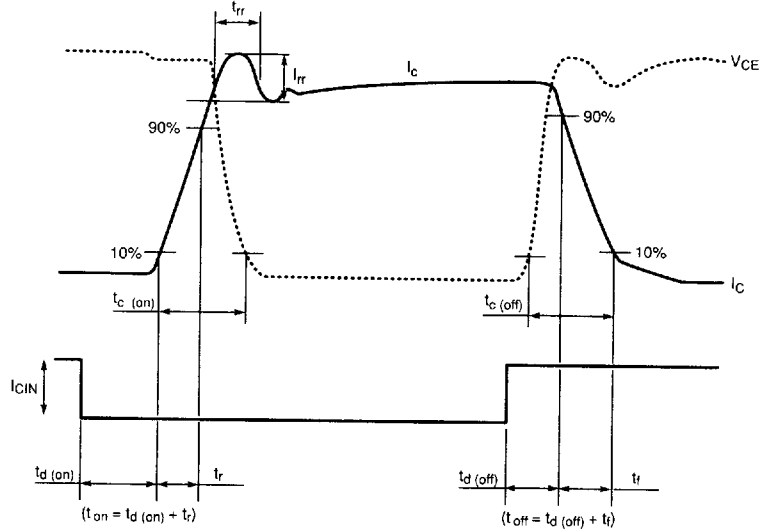

Figure 5 Switching Test Waveform

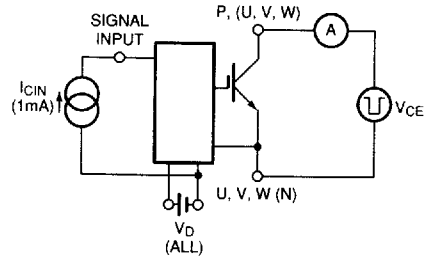

Figure 6 I_{CES} Test

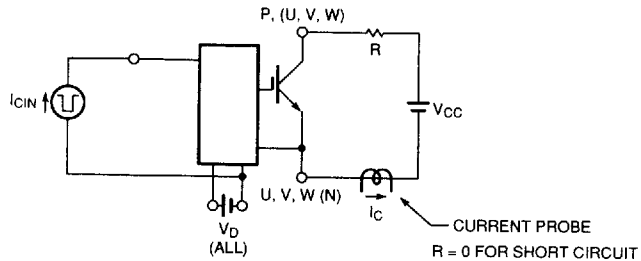

Figure 7 Over Current and Short Circuit Test