

KESIT A-A

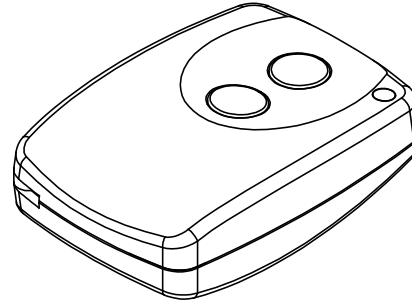

Option 1

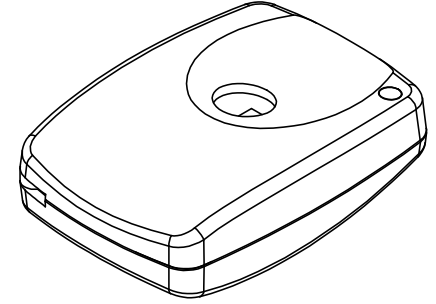

Option 2

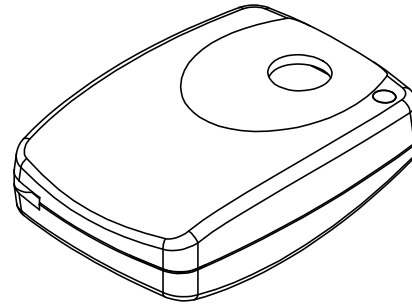

Option 3

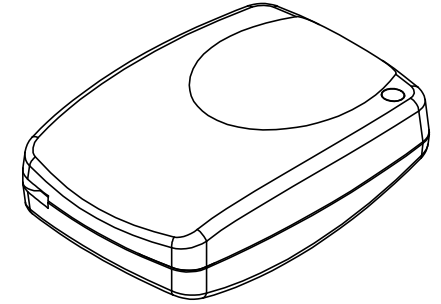

Option 4

NAME	DATE	ARTICLE NO:	REVISION:	TITLE:	
DRAWN Dursun Daşdemir				RC-040	
CHECKED Ali Altınışık		COMMENTS: This drawing is subject to technical modification without prior notice. Typographical and other errors do not justify any claims for damages. All dimensions should be verified using an actual produced part.			
 www.altinkaya.com.tr		DİKKAT: BU RESİM VE ÜRÜN ÖNCEDEN HABER VERİLMEKSİZİN DEĞİŞTİREBİLİR. RESİM ÇİZİLİRKEN HATASIZ OLMASINA ÇALIŞILMASINA RAĞMEN RESİMDE HATALAR BULUNABİLİR. RESİMDEKİ HATALARDAN DOLAYI OLUŞABİLECEK ZARARLAR İÇİN ALTINKAYA HİÇ BİR SORUMLULUK KABUL ETMEZ. BÜTÜN ÖLÇÜLER KULLANILMADAN ÖNCE ÜRETİLMİŞ GERÇEK BİR NUMUNEDEN KONTROL EDİLMELİDİR.		DWG NO:	A4
PROPRIETARY AND CONFIDENTIAL <small>THE INFORMATION CONTAINED IN THIS DRAWING IS THE SOLE PROPERTY OF ALTINKAYA ENCLOSURES. ANY REPRODUCTION IN PART OR AS A WHOLE, WITHOUT THE WRITTEN PERMISSION OF ALTINKAYA ENCLOSURES IS PROHIBITED.</small>		MATERIAL:	WEIGHT:	SCALE:	SHEET OF

Button Switch

Led Center

Para Pil Yuvası
Merkezi

2032 Pil

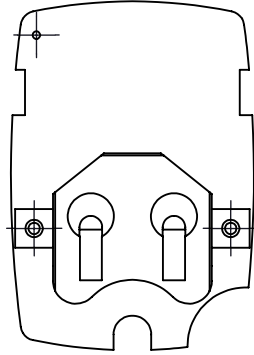
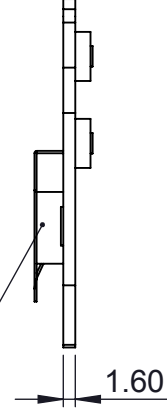
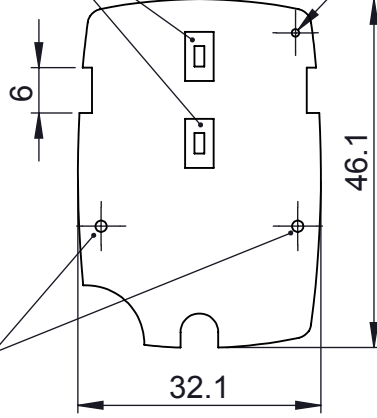

	NAME	DATE	ARTICLE NO:	REVISION:	TITLE:	
DRAWN	Dursun Daşdemir				PCB sample (Not Included)	
CHECKED	Ali Altınışık					
F	 ENCLOSURES FOR ELECTRONICS www.altinkaya.com.tr		COMMENTS: This drawing is subject to technical modification without prior notice. Typographical and other errors do not justify any claims for damages. All dimensions should be verified using an actual produced part.		DWG NO.	
			DİKKAT: BU RESİM VE ÜRÜN ÖNCEDEN HABER VERİLMEKSİZİN DEĞİŞTİREBİLİR. RESİM ÇİZİLİRKEN HATALAR BULUNABİLİR. ÇALIŞILMASINA RAĞMEN RESİMDE HATALAR BULUNABİLİR. RESİMDEKİ HATALARDAN DOLAYI OLUŞABİLECEK ZARARLAR İÇİN ALTINKAYA HIÇ BİR SORUMLULUK KABÜL ETMEZ. BÜTÜN ÖLÇÜLER KULLANILMADAN ÖNCE ÜRETİLMİŞ GERÇEK BİR NUMUNEDEN KONTROL EDİLMELİDİR.			A4
PROPRIETARY AND CONFIDENTIAL THE INFORMATION CONTAINED IN THIS DRAWING IS THE SOLE PROPERTY OF ALTINKAYA ENCLOSURES. ANY REPRODUCTION IN PART OR AS A WHOLE WITHOUT THE WRITTEN PERMISSION OF ALTINKAYA ENCLOSURES IS PROHIBITED.			MATERIAL:	WEIGHT:	SCALE:1:1	SHEET OF



Button Switch

Led Center

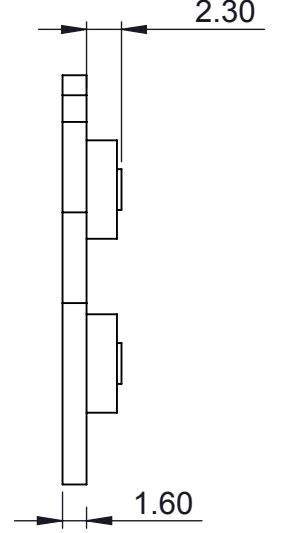
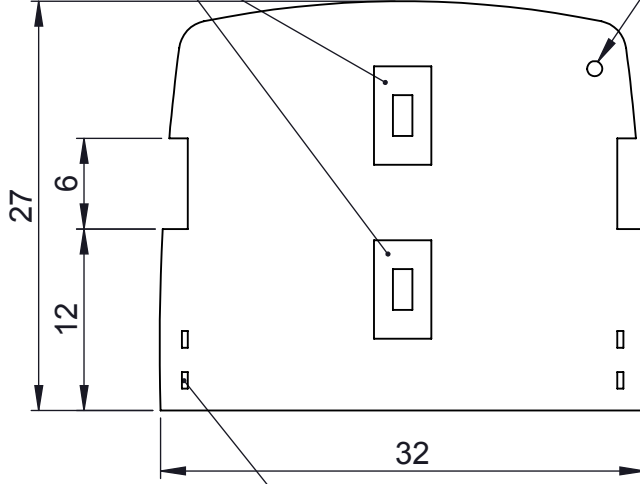

For Battery Contact

PCB Sample
(Not Included)

	NAME	DATE	ARTICLE NO:	REVISION:	TITLE:
DRAWN	Dursun Daşdemir				PCB Sample (Not Included)
CHECKED	Ali Altınışık				

ALTINKAYA
ENCLOSURES FOR ELECTRONICS
www.altinkaya.com.tr

COMMENTS: This drawing is subject to technical modification without prior notice. Typographical and other errors do not justify any claims for damages. All dimensions should be verified using an actual produced part.

DİKKAT: BU RESİM VE ÜRÜN ÖNCEDEN HABER VERİLMEKSİZİN DEĞİŞTİREBİLİR. RESİM ÇİZİLİRKEN HATALAR BULUNABİLİR. ÇALIŞILMASINA RAĞMEN RESİMDE HATALAR BULUNABİLİR. RESİMDEKİ HATALARDAN DOLAYI OLUŞABİLECEK ZARARLAR İÇİN ALTINKAYA HIÇ BİR SORUMLULUK KABÜL ETMEZ. BÜTÜN ÖLÇÜLER KULLANILMADAN ÖNCE ÜRETİLMİŞ GERÇEK BİR NUMUNEDEN KONTROL EDİLMELİDİR.

DWG NO.

A4

PROPRIETARY AND CONFIDENTIAL
THE INFORMATION CONTAINED IN THIS DRAWING IS THE SOLE PROPERTY OF ALTINKAYA ENCLOSURES. ANY REPRODUCTION IN PART OR AS A WHOLE WITHOUT THE WRITTEN PERMISSION OF ALTINKAYA ENCLOSURES IS PROHIBITED.

MATERIAL:

WEIGHT:

SCALE:

SHEET OF

