

KESIT A-A

DİKKAT: BU RESİM VE ÜRÜN ÖNCEDEN HABER VERİLMEKSİZİN DEĞİŞTİREBİLİR. RESİM ÇİZİLİRKEN HATASIZ OLMASINA ÇALIŞILMASINA RAĞMEN RESİMDE HATALARDAN DOLAYI OLUŞABİLECEK ZARARLAR İÇİN ALTINKAYA HiÇ BİR SORUMLULUK KABUL ETMEZ. BÜTÜN ÖLÇÜLER KULLANILMADAN ÖNCE ÜRETİLMİŞ GERÇEK NUMUNEDEN KONTROL EDİLMELİDİR.

PROPRIETARY AND CONFIDENTIAL  
THE INFORMATION CONTAINED IN THIS  
DRAWING IS THE SOLE PROPERTY OF  
ALTINKAYA ENCLOSURES. ANY  
REPRODUCTION IN PART OR AS A WHOLE  
WITHOUT THE WRITTEN PERMISSION OF  
ALTINKAYA ENCLOSURES IS PROHIBITED.

	NAME	DATE
DRAWN	Hayri BAL	05.11.19
CHECKED	Dursun Dağdemir	05.11.19

COMMENTS: This drawing is subject to technical modification without prior notice. Typographical and other errors do not justify any claims for damages. All dimensions should be verified using an actual produced part.

MATERIAL:

WEIGHT:

ARTICLE NO. REVISION:

**ALTINKAYA**  
ENCLOSURES FOR ELECTRONICS  
CONTACT:  
[www.altinkaya.com.tr](http://www.altinkaya.com.tr)

TITLE:  
**SE-202 IP-67  
Heavy Duty Enclosure**

DWG NO. **SE-202-0-0** A3

SCALE:1:1 SHEET 1 OF 1

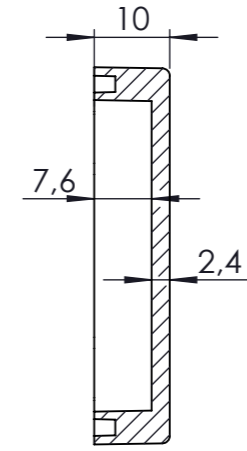
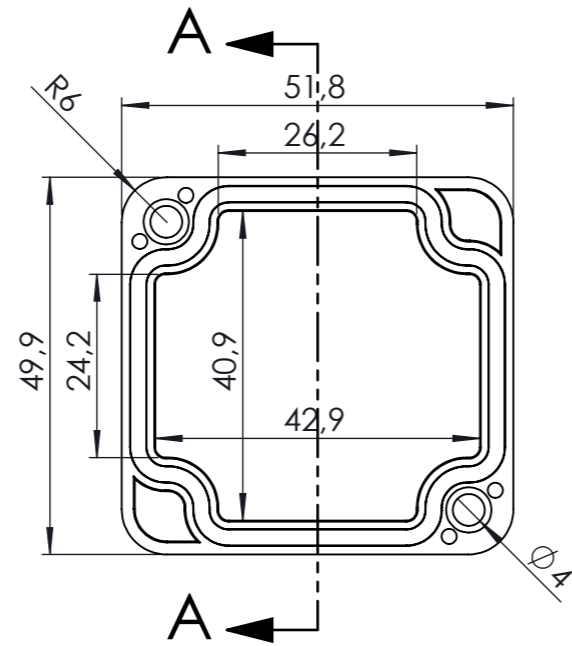

KESIT A-A

DİKKAT: BU RESİM VE ÜRÜN ÖNCEDEN HABER VERİLMEKSİZİN DEĞİŞTİRİLEBİLİR. RESİM ÇİZİLİRKEN HATASIZ OLMASINA ÇALIŞILMASINA RAĞMEN RESİMDEKİ HATALARDAN DOLAYI OLUŞABİLECEK ZARARLAR İÇİN ALTINKAYA HiÇ BİR SORUMLULUK KABUL ETMEZ. BÜTÜN ÖLÇÜLER KULLANILMADAN ÖNCE ÜRETİLMİŞ GERÇEK NUMUNEDEN KONTROL EDİLMELİDİR.

PROPRIETARY AND CONFIDENTIAL THE INFORMATION CONTAINED IN THIS DRAWING IS THE SOLE PROPERTY OF ALTINKAYA ENCLOSURES. ANY REPRODUCTION IN PART OR AS A WHOLE WITHOUT THE WRITTEN PERMISSION OF ALTINKAYA ENCLOSURES IS PROHIBITED.			ARTICLE NO:	REVISION:
DRAWN Hayri BAL 05.11.19			 <b>ALTINKAYA</b> ENCLOSURES FOR ELECTRONICS	CONTACT: <a href="http://www.altinkaya.com.tr">www.altinkaya.com.tr</a>
CHECKED Dursun Daşdemir 05.11.19				TITLE: <b>SE-202 KAPAK</b>
COMMENTS: This drawing is subject to technical modification without prior notice. Typographical and other errors do not justify any claims for damages. All dimensions should be verified using an actual produced part.			DWG NO: <b>SE-202-P-1</b>	A3
MATERIAL:			SCALE:1:1	SHEET 1 OF 1
WEIGHT:				

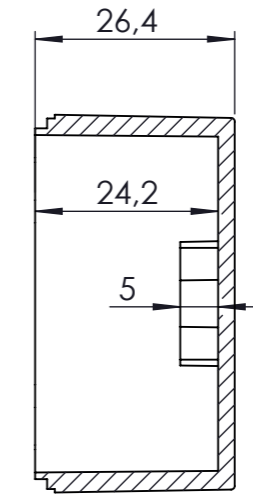
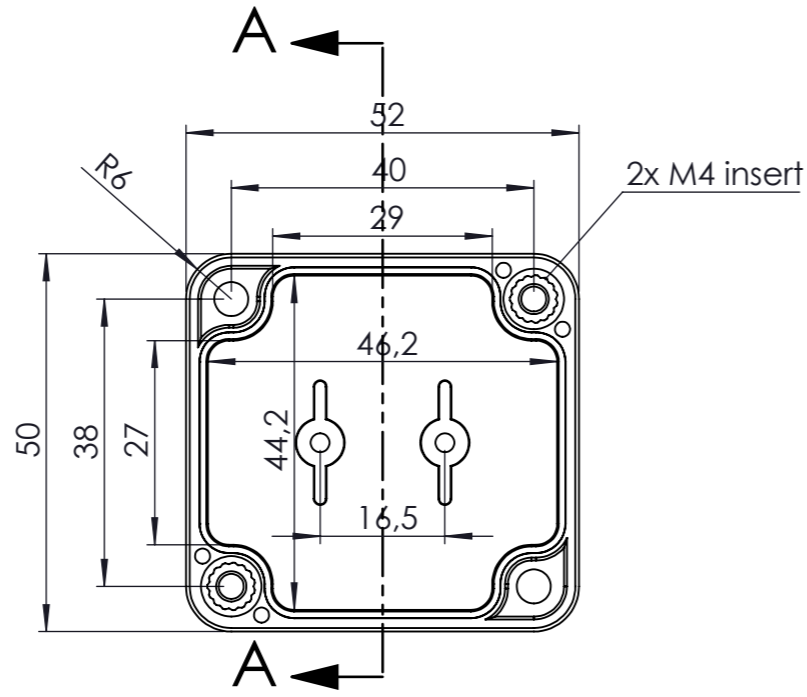

KESIT A-A

DİKKAT: BU RESİM VE ÜRÜN ÖNCEDEN HABER VERİLMEKSİZİN DEĞİŞTİRİLEBİLİR. RESİM ÇİZİLİRKEN HATASIZ OLMASINA ÇALIŞILMASINA RAĞMEN RESİMDEKİ HATALARDAN DOLAYI OLUŞABİLECEK ZARARLAR İÇİN ALTINKAYA HiÇ BİR SORUMLULUK KABUL ETMEZ. BÜTÜN ÖLÇÜLER KULLANILMADAN ÖNCE ÜRETİLMİŞ GERÇEK NUMUNEDEN KONTROL EDİLMELİDİR.

<small>PROPRIETARY AND CONFIDENTIAL THE INFORMATION CONTAINED IN THIS DRAWING IS THE SOLE PROPERTY OF ALTINKAYA ENCLOSURES. ANY REPRODUCTION IN PART OR AS A WHOLE WITHOUT THE WRITTEN PERMISSION OF ALTINKAYA ENCLOSURES IS PROHIBITED.</small>			ARTICLE NO:	REVISION:
<small>DRAWN</small> Hayri BAL 05.11.19 <small>CHECKED</small> Dursun Dağdemir 05.11.19			 <b>ALTINKAYA</b> <small>ENCLOSURES FOR ELECTRONICS</small>	CONTACT: <a href="http://www.altinkaya.com.tr">www.altinkaya.com.tr</a>
<small>COMMENTS: This drawing is subject to technical modification without prior notice. Typographical and other errors do not justify any claims for damages. All dimensions should be verified using an actual produced part.</small>			TITLE: <h2>SE-202 GÖVDE</h2>	
MATERIAL:			DWG NO: <h2>SE-202-P-2</h2>	A3
WEIGHT:			SCALE:1:1	SHEET 1 OF 1

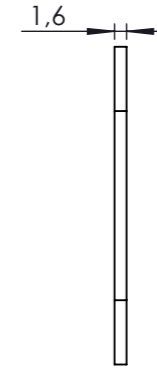
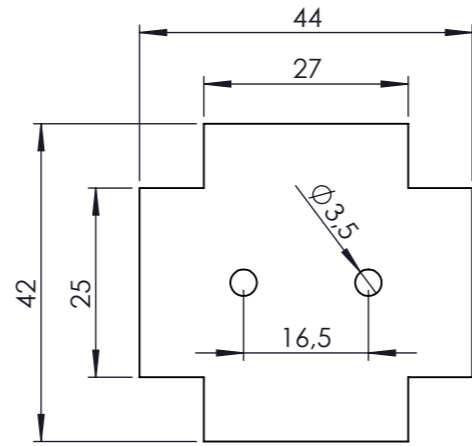
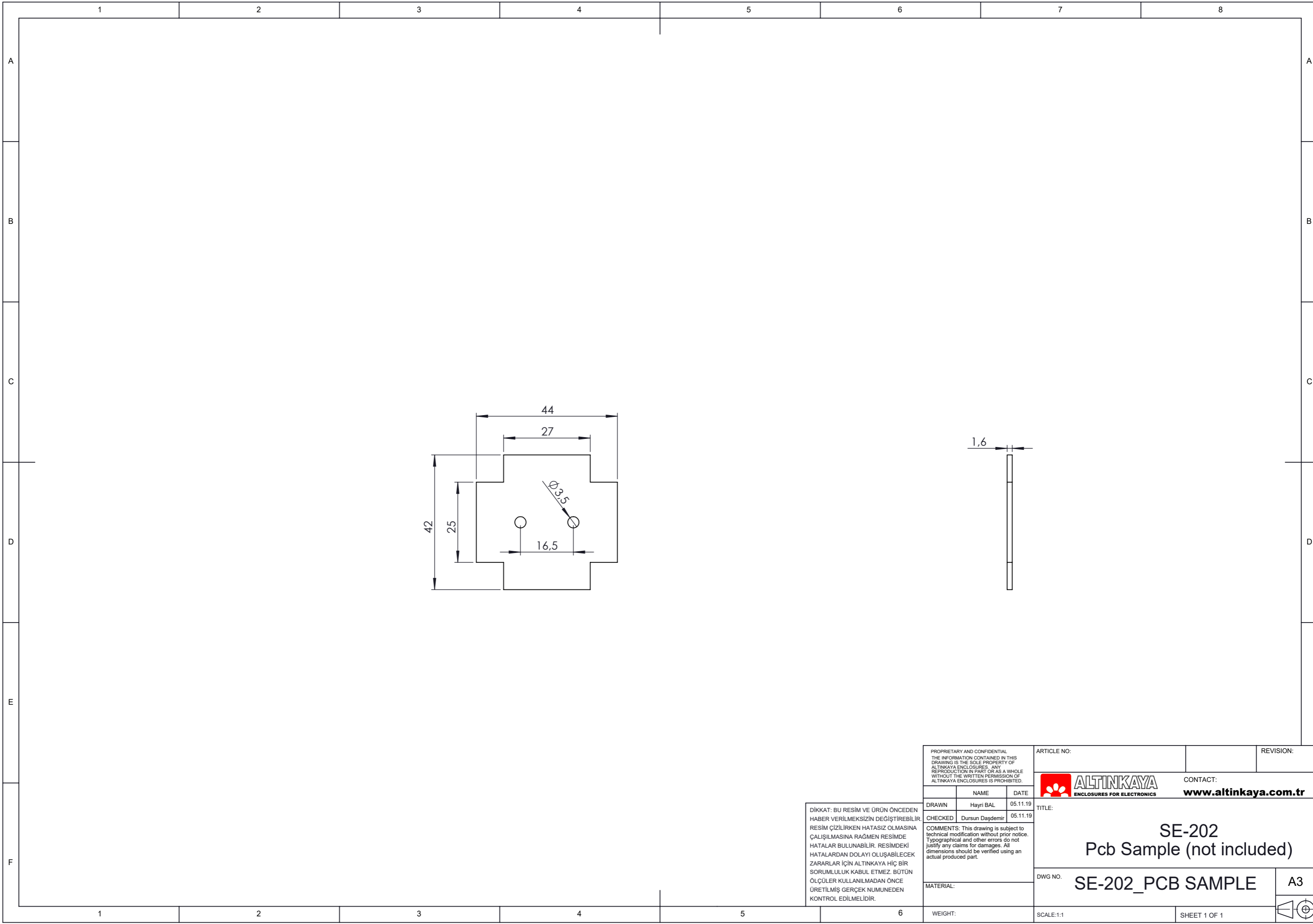

DİKKAT: BU RESİM VE ÜRÜN ÖNCEDEN HABER VERİLMEKSİZİN DEĞİŞTİREBİLİR. RESİM ÇİZİLİRKEN HATASIZ OLMASINA ÇALIŞILMASINA RAĞMEN RESİMDEKİ HATALARDAN DOLAYI OLUŞABİLECEK ZARARLAR İÇİN ALTINKAYA HİÇ BİR SORUMLULUK KABUL ETMEZ. BÜTÜN ÖLÇÜLER KULLANILMADAN ÖNCE ÜRETİLMİŞ GERÇEK NUMUNEDEN KONTROL EDİLMELİDİR.

PROPRIETARY AND CONFIDENTIAL  
THE INFORMATION CONTAINED IN THIS  
DRAWING IS THE SOLE PROPERTY OF  
ALTINKAYA ENCLOSURES. ANY  
REPRODUCTION IN PART OR AS A WHOLE  
WITHOUT THE WRITTEN PERMISSION OF  
ALTINKAYA ENCLOSURES IS PROHIBITED.

	NAME	DATE
DRAWN	Hayri BAL	05.11.19
CHECKED	Dursun Dağdemir	05.11.19

COMMENTS: This drawing is subject to technical modification without prior notice. Typographical and other errors do not justify any claims for damages. All dimensions should be verified using an actual produced part.

MATERIAL:

WEIGHT:

ARTICLE NO. REVISION:

 CONTACT: [www.altinkaya.com.tr](http://www.altinkaya.com.tr)

TITLE: SE-202  
Pcb Sample (not included)

DWG NO. SE-202\_PCB SAMPLE A3

SCALE:1:1 SHEET 1 OF 1