

SFH628A-2, SFH628A-3,  
SFH628A-4



**LOW INPUT CURRENT  
PHOTOTRANSISTOR  
OPTICALLY COUPLED ISOLATORS**

**APPROVALS**

- UL recognised, File No. E91231  
**'X' SPECIFICATION APPROVALS**
- VDE 0884 approval pending

**DESCRIPTION**

The SFH628A series of optically coupled isolators consist of inverse parallel infrared light emitting diodes and NPN silicon photo transistors in space efficient dual in line plastic packages.

**FEATURES**

- Options :-  
10mm lead spread - add G after part no.  
Surface mount - add SM after part no.  
Tape&reel - add SMT&R after part no.
- Low input current  $\pm 0.5\text{mA } I_F$
- High Current Transfer Ratios  
(63-500% at  $\pm 1\text{mA}$ , 32% min at  $\pm 0.5\text{mA}$ )
- High Isolation Voltage ( $5.3\text{kV}_{\text{RMS}}, 7.5\text{kV}_{\text{PK}}$ )
- High  $BV_{\text{CEO}}$  (55V min)
- All electrical parameters 100% tested
- Custom electrical selections available

**APPLICATIONS**

- Computer terminals
- Industrial systems controllers
- Measuring instruments
- Signal transmission between systems of different potentials and impedances

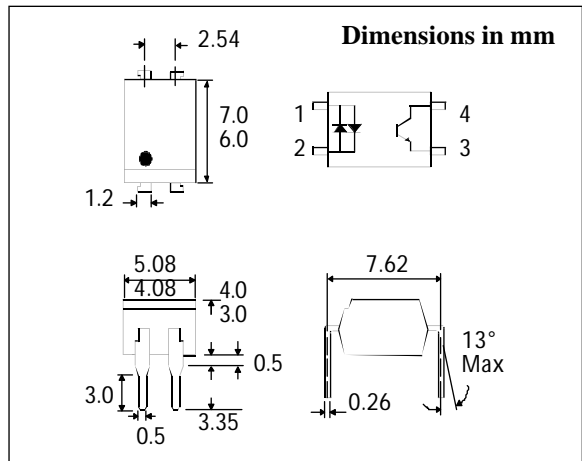

**ABSOLUTE MAXIMUM RATINGS  
(25°C unless otherwise specified)**

Storage Temperature \_\_\_\_\_ -55°C to + 125°C  
Operating Temperature \_\_\_\_\_ -55°C to + 100°C  
Lead Soldering Temperature  
(1/16 inch (1.6mm) from case for 10 secs) 260°C

**INPUT DIODE**

Forward Current \_\_\_\_\_  $\pm 50\text{mA}$   
Power Dissipation \_\_\_\_\_ 70mW

**OUTPUT TRANSISTOR**

Collector-emitter Voltage  $BV_{\text{CEO}}$  \_\_\_\_\_ 55V  
Emitter-collector Voltage  $BV_{\text{ECO}}$  \_\_\_\_\_ 6V  
Power Dissipation \_\_\_\_\_ 150mW

**POWER DISSIPATION**

Total Power Dissipation \_\_\_\_\_ 200mW  
(derate linearly 2.67mW/°C above 25°C)

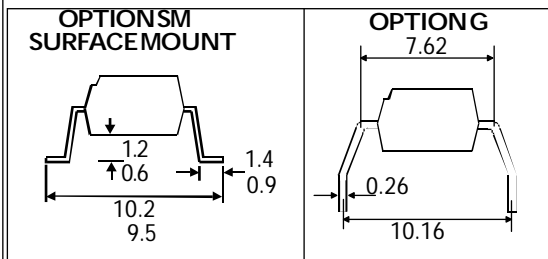

**ISOCOM COMPONENTS LTD**  
Unit 25B, Park View Road West,  
Park View Industrial Estate, Brenda Road  
Hartlepool, Cleveland, TS25 1YD  
Tel: (01429) 863609 Fax :(01429) 863581

**ISOCOM INC**  
720 E., Park Boulevard, Suite 104,  
Plano, TX 75074 USA  
Tel: (972) 423-5521  
Fax: (972) 422-4549

**ELECTRICAL CHARACTERISTICS (  $T_A = 25^\circ\text{C}$  Unless otherwise noted )**

PARAMETER		MIN	TYP	MAX	UNITS	TEST CONDITION
Input	Forward Voltage ( $V_F$ )			1.5	V	$I_F = \pm 5\text{mA}$
Output	Collector-emitter Breakdown ( $BV_{CEO}$ ) ( Note 2 )	55			V	$I_C = 1\text{mA}$
	Emitter-collector Breakdown ( $BV_{ECO}$ )	6			V	$I_E = 100\mu\text{A}$
	Collector-emitter Dark Current ( $I_{CEO}$ )			200	nA	$V_{CE} = 10\text{V}$
Coupled	Current Transfer Ratio (CTR) (Note 2)					
	SFH628A-2	63		200	%	$\pm 1\text{mA } I_F, 0.5\text{V } V_{CE}$
	SFH628A-2	32			%	$\pm 0.5\text{mA } I_F, 1.5\text{V } V_{CE}$
	SFH628A-3	100		320	%	$\pm 1\text{mA } I_F, 0.5\text{V } V_{CE}$
	SFH628A-3	50			%	$\pm 0.5\text{mA } I_F, 1.5\text{V } V_{CE}$
	SFH628A-4	160		500	%	$\pm 1\text{mA } I_F, 0.5\text{V } V_{CE}$
	SFH628A-4	80			%	$\pm 0.5\text{mA } I_F, 1.5\text{V } V_{CE}$
	Collector-emitter Saturation Voltage $V_{CESAT}$					
	SFH628A-2			0.4	V	$\pm 1\text{mA } I_F, 0.5\text{mA } I_C$
	SFH628A-3			0.4	V	$\pm 1\text{mA } I_F, 0.8\text{mA } I_C$
SFH628A-4			0.4	V	$\pm 1\text{mA } I_F, 1.25\text{mA } I_C$	
Input to Output Isolation Voltage $V_{ISO}$	5300				$V_{RMS}$	See note 1
	7500				$V_{PK}$	See note 1
Input-output Isolation Resistance $R_{ISO}$	$5 \times 10^{10}$				$\Omega$	$V_{IO} = 500\text{V}$ (note 1)

Note 1 Measured with input leads shorted together and output leads shorted together.  
 Note 2 Special Selections are available on request. Please consult the factory.

**SWITCHING CHARACTERISTICS**

$I_C = 2\text{mA}, V_{CC} = 5\text{V}, R_L = 100\Omega, T_A = 25^\circ\text{C}$  (Fig 1)

			UNITS
Turn-on Time	$t_{on}$	6.0	$\mu\text{s}$
Rise Time	$t_r$	3.5	$\mu\text{s}$
Turn-off Time	$t_{off}$	5.5	$\mu\text{s}$
Fall Time	$t_f$	5.0	$\mu\text{s}$

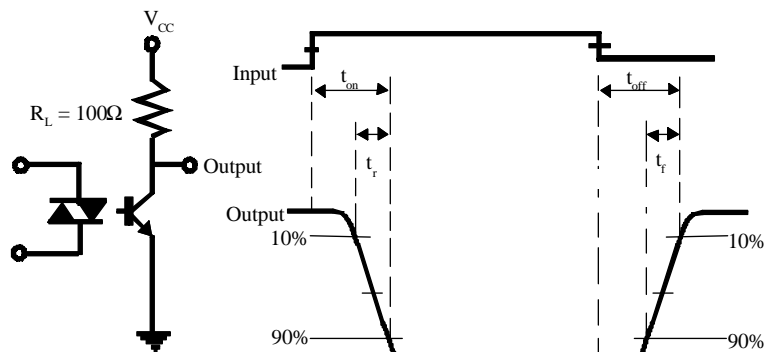
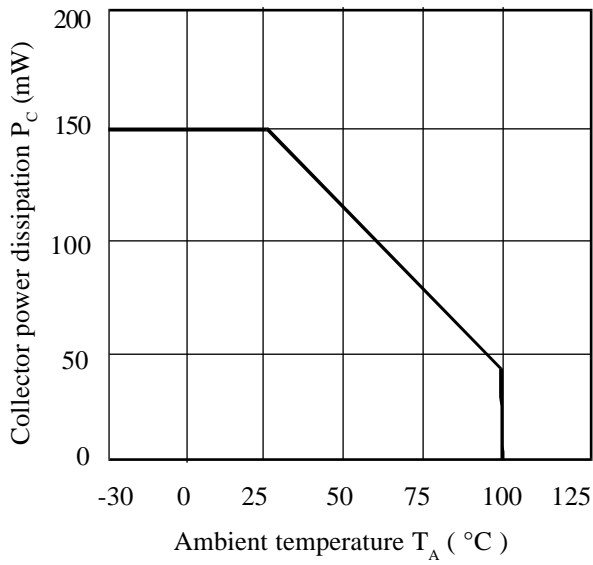
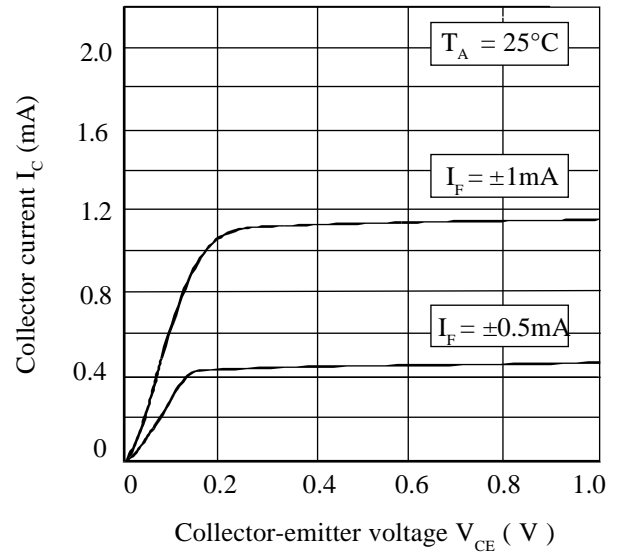

FIG 1

**Collector Power Dissipation vs. Ambient Temperature**



**Collector Current vs. Low Collector-emitter Voltage (normalized to SFH628A-2 & SFH628A-3)**



**Forward Current vs. Ambient Temperature**

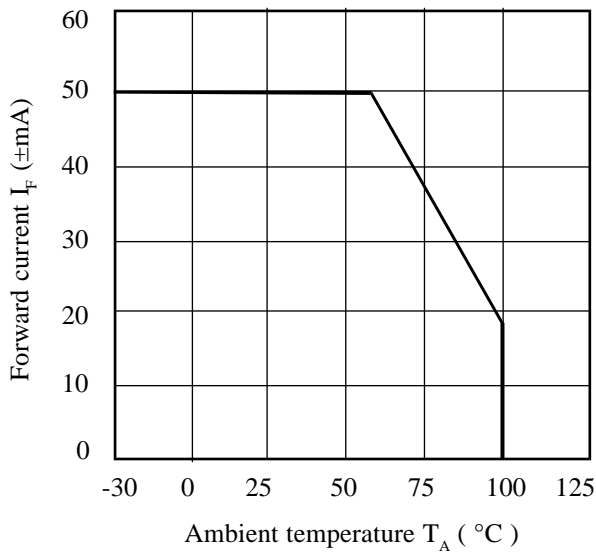

**Relative Current Transfer Ratio vs. Ambient Temperature**

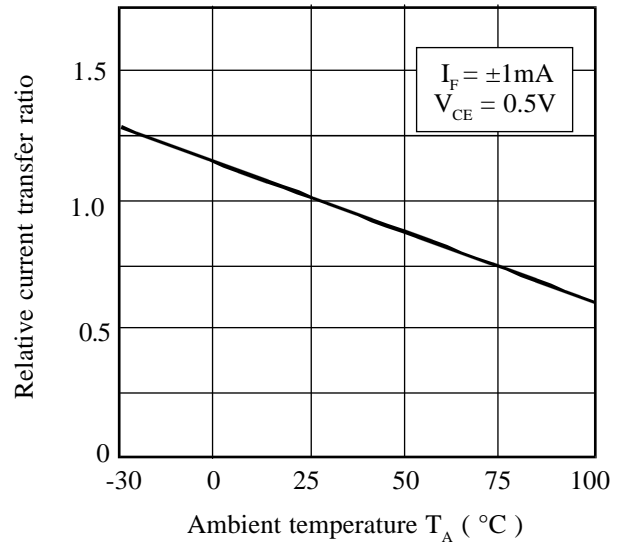

**Collector-emitter Saturation Voltage vs. Ambient Temperature**

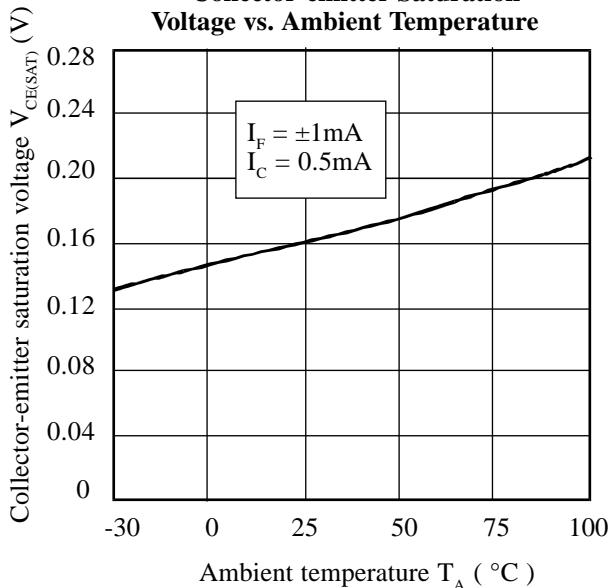

**Current Transfer Ratio vs. Forward Current (normalized to SFH628A-2 & SFH628A-3)**

