

FEATURES

- 2.8V to 5.5V Operating Range
- Adjustable Current Limit : 200mA to 2.25A(Typ.)
- Fold-back Short Circuit Protection
- 130uA Typical On-State Supply Current
- 5uA Maximum Standby Supply Current
- Independent Open-drain Fault Flag Pin
- Thermal Shutdown Protection
- Under Voltage Lockout(UVLO)
- Output Auto Discharge Function
- Reverse Current Protection
- TJ2242 : Active High version

APPLICATION

- USB Peripherals
- General Purpose Power Switching
- ACPI Power Distribution
- Notebook PCs
- PDAs
- Hot Plug-in Power Supplies

DESCRIPTION

The TJ2242 is single-channel High-Side MOSFET switch optimized for adjustable current limited power distribution requiring circuit protection. The TJ2242 series support the following USB requirements. The TJ2242 series supply up to 2.25A as required by USB downstream devices. Maximum continuous current can be different on the types of package and ambient temperature. Switch's low on-resistance meets USB voltage drop requirement. Flag output indicate fault condition to the local USB controller. Soft-start prevents the transient voltage drop on the upstream port that can occur when the switch is enabled in bus-powered applications. Under voltage lockout (UVLO) feature disables the output switches until a valid input voltage. Auto discharge function quickly lowers the V_{OUT} to the ground level when the TJ2242 turns off. Also the TJ2242 include thermal shutdown to prevent switch failure from high-current loads and reverse current protection circuit to prevent the reverse current from V_{OUT} pin to V_{IN} pin.

SOT-23-6L

**ORDERING INFORMATION**

Device	Package
TJ2242GSF6	SOT-23-6L

Absolute Maximum Ratings (Note 1)

Characteristic	Symbol	Min	Max	Unit
Supply Voltage	V_{IN}	-0.3	6.5	V
Enable Input Voltage (Note 2)	V_{EN}	-0.3	6.5	V
Fault Flag Voltage	V_{FLG}	-	6.5	V
Fault Flag Current	I_{FLAG}	-	10	mA
Output Voltage	V_{OUT}		6.5	V
Output Current	I_{OUT}		Internally Limited	
Storage Temperature Range	T_{STG}	-65	150	°C

Operating Ratings (Note 3),(Note 4)

Characteristic	Symbol	Min	Max	Unit
Supply Voltage	V_{IN}	2.8	5.5	V
Ambient Temperature Range	T_A	-40	80	°C
Operating Junction Temperature Range	T_J	-40	125	°C
Thermal Resistance Junction-to-Ambient (Note 5)	SOT-23-6L θ_{JA}		250	°C/W

Note:

1. Exceeding the absolute maximum ratings may damage the device.
2. It is recommended for V_{EN} voltage not to exceed V_{IN} voltage.
3. The device is not guaranteed to function outside its operating rating.
4. Devices are ESD sensitive. Handling precautions are recommended.
5. Test Condition for SOT-23-6L : Copper Area = 35mm², Board Size : 430mm X 430mm, 1.6T

Ordering Information

Package	Oder No.	Description	Marking	Compliance	Status
SOT-23-6L	TJ2242GSF6	Adjustable , Active High	TJ2242	RoHS, Green	Contact Us

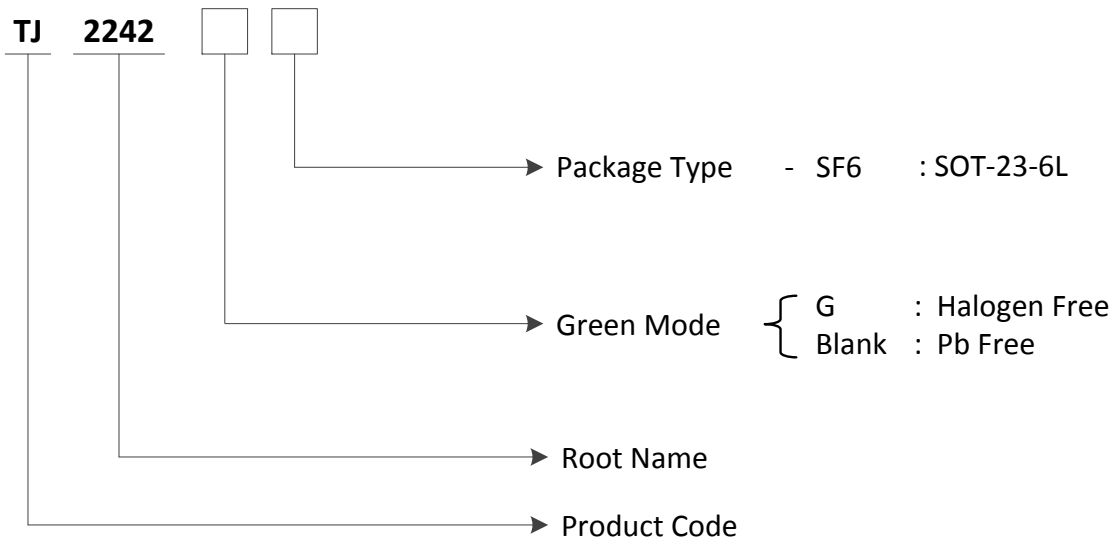

TYPICAL APPLICATION CIRCUIT

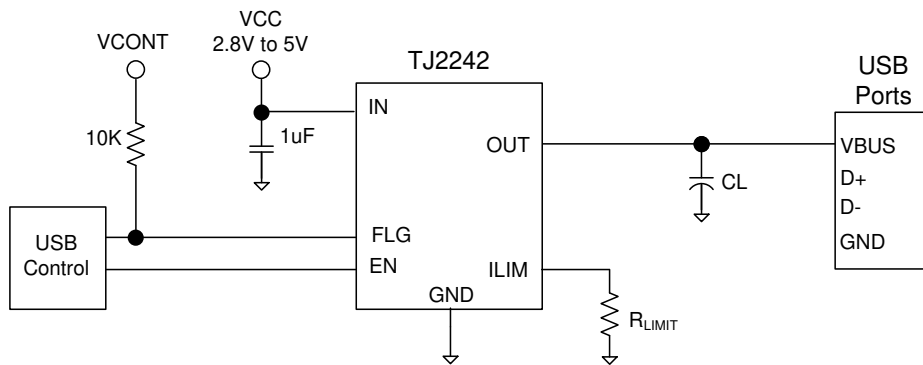

FUNCTION BLOCK DIAGRAM

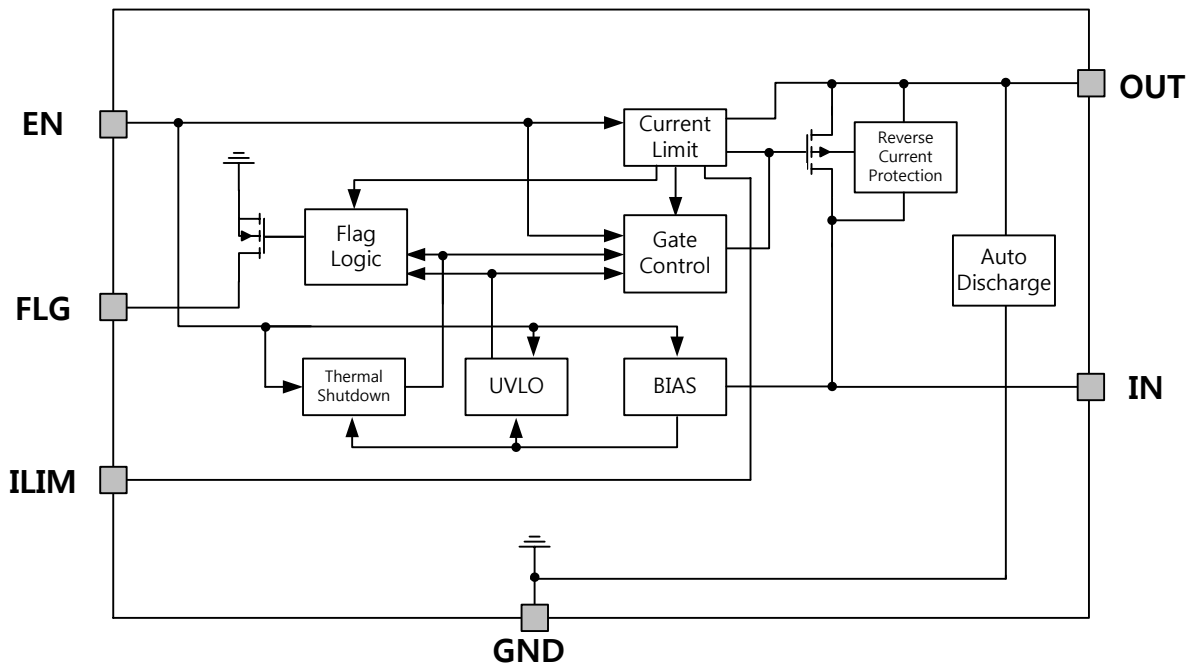

PIN CONFIGURATION

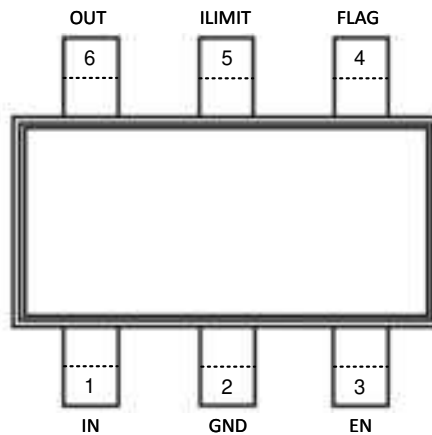

PIN DESCRIPTION

Pin Name	Pin No.	Pin Description & Function
	SOT-23-6L	
IN	1	Supply Input : Output MOSFET source. Also supplies IC's internal circuitry. Connect to positive supply.
GND	2	Ground
EN	3	Enable : Logic-Compatible enable input, Do not float.
FLAG	4	Fault Flag : Active-low, open-drain output. Indicates Short circuit current and Thermal shutdown
ILIMIT	5	Current Limit Set : External resistor used to set current limit threshold.
OUT	6	Switch Output : Output MOSFET drain. Typically connect to switched side of load

ELECTRICAL CHARACTERISTICS (Under the conditions of $V_{IN}=+5V$ and $T_A=25^{\circ}C$)

PARAMETER	Symbol	CONDITIONS	MIN	TYP	MAX	UNITS
Operating Voltage Range	V_{IN}		2.8		5.5	V
Recommended Maximum Continuous Current (Note 8)		SOT-23-6L package		1.5		A
Supply Current	I_{CC}	Enable off ,OUT=Open		1	5	μA
		Enable on, OUT=Open		130	180	μA
Enable Input Threshold	V_{EN}	(Note 9)	0.8		2.1	V
Enable Input Current	I_{EN}	$V_{EN} = 0V$ to 5.5V	-1	0.01	1	μA
Enable Input Capacitance	C_{EN}			1		pF
Switch Resistance	$R_{DS(ON)}$	$V_{IN}=5V, I_{OUT}=0.5A$		100	120	m Ω
Output Turn-On Delay	T_{DON}	$R_L=5\Omega$ each output, $C_L=1\mu F$		1.5	5	ms
Output Turn-On Rise Time	T_R	$R_L=5\Omega$ each output, $C_L=1\mu F$		1	5	ms
Output Turn-Off Delay	T_{DOFF}	$R_L=5\Omega$ each output, $C_L=1\mu F$		100	150	μs
Output Turn-On Fall Time	T_F	$R_L=5\Omega$ each output, $C_L=1\mu F$		50	100	μs
Output leakage Current	I_{LEAK}	$V_{EN}\leq 0.8V$		0.01	5	μA
Current Limit Threshold (Note 11)	I_{LIM}	$R_{LIMIT} = 75k\Omega$		200		mA
		$R_{LIMIT} = 14k\Omega$		1036		mA
		$R_{LIMIT} = 7k\Omega$		2044		mA
Short Circuit Current Limit	I_{SC}	$R_{LIMIT} = 75k\Omega, V_{OUT}=0V$		112		mA
		$R_{LIMIT} = 14k\Omega, V_{OUT}=0V$		580		mA
		$R_{LIMIT} = 7k\Omega, V_{OUT}=0V$		1144		mA
Over-Temperature Shutdown Threshold	T_{SD}	Thermal Shutdown Temperature		150		$^{\circ}C$
	T_{HYS}	Hysteresis		20		$^{\circ}C$
Error Flag Output Resistance	R_{FO}	$V_{IN}=5V, I_L=10mA$		20		Ω
Error Flag Off Current	I_{FOH}	$V_{FLAG}=5V$		0.01	10	μA
Output Discharge Resistance	R_{DISC}	$V_{IN}=5V, V_{EN}=0V$		100		Ω
UVLO Threshold	UVLO	$V_{IN} =$ increasing	2.3	2.45	2.6	V
		$V_{IN} =$ decreasing	2.1	2.35	2.4	V
Overcurrent Flag Response Delay	T_{DFOV}	$V_{IN}=5V,$ apply $V_{OUT}=0V$ until FLG low		7	15	ms
Current Limit Response Time	T_{LIM}	(Note 10)		1		μs

Note:

8. Maximum ambient temperature is a function of device junction temperature and system level considerations, such as load current, power dissipation and board layout.
9. OFF is $V_{EN}\leq 0.8V$ and ON is $V_{EN}\geq 2.0V$ for the TJ2242.
10. T_{LIM} is the response time to operate current limit when the peak value of the current is increased more than set limit value.
11. It is recommended that current limit level set to 1.5 times more than constant current for a stable power supply.

Test Circuit

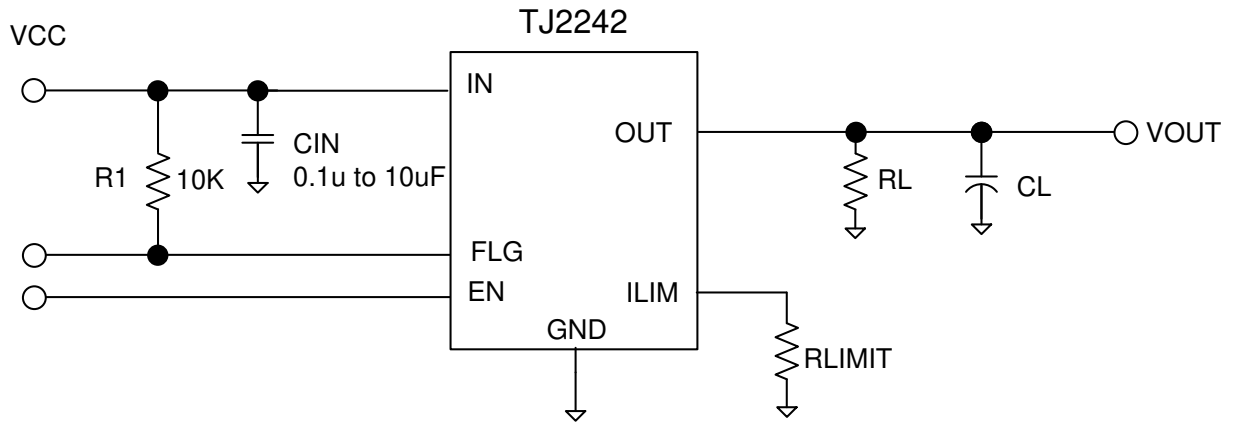

TYPICAL PERFORMANCE CHARACTERISTICS

- $V_{IN}=5V$, $V_{EN}=5V$, $T_A=25^\circ C$, $R_{LIMIT}=15K\Omega$, $C_{IN}=1\mu F$, $C_L=10\mu F$ unless otherwise noted.

On-Current vs. Supply Voltage

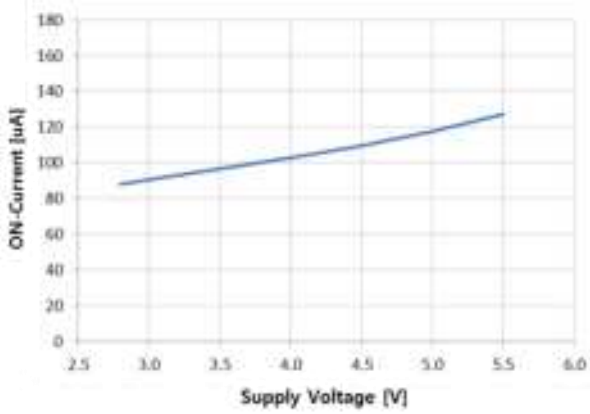

On-Current vs. Temperature

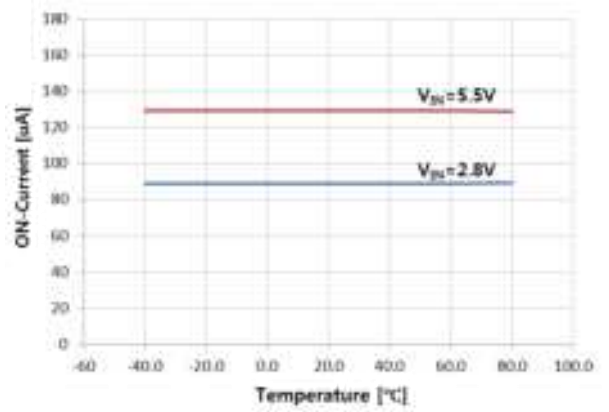

Off-Current vs. Supply Voltage

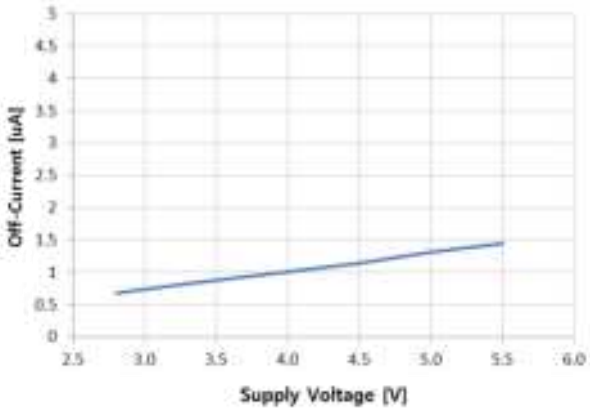

Off-Current vs. Temperature

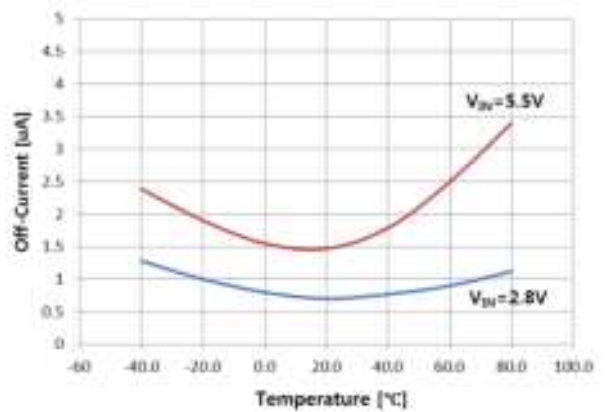

Enable Threshold vs. Supply Voltage

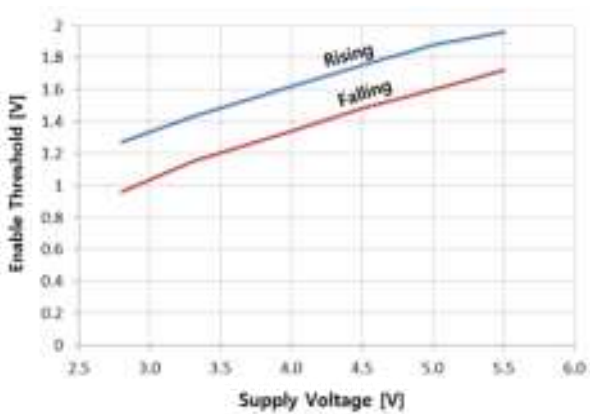

Enable Threshold vs. Temperature

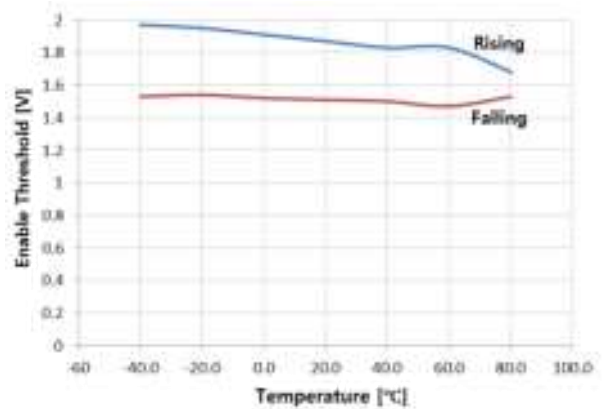

UVLO Threshold vs. Temperature

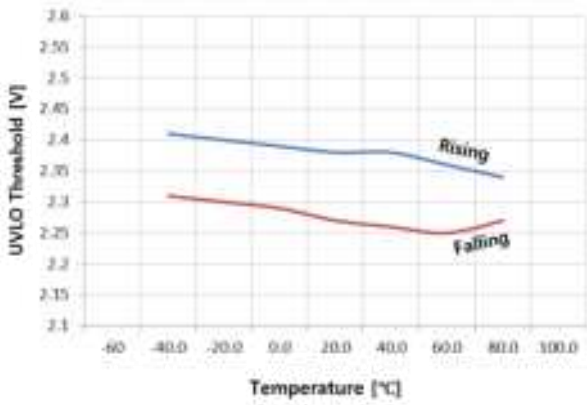

Vflag Delay Time vs. Temperature

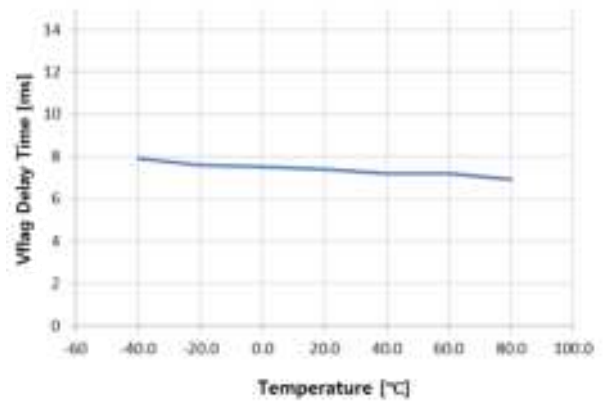

On-Resistance vs. Supply Voltage

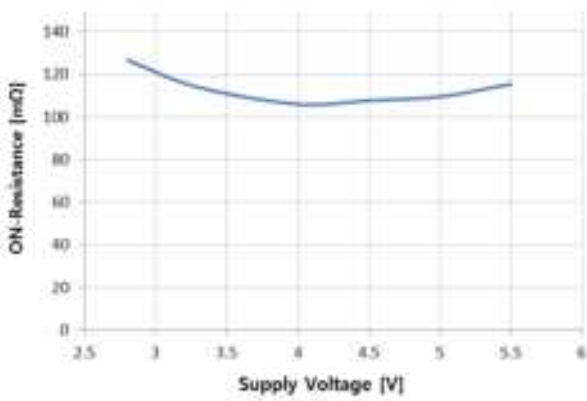

On-Resistance vs. Temperature

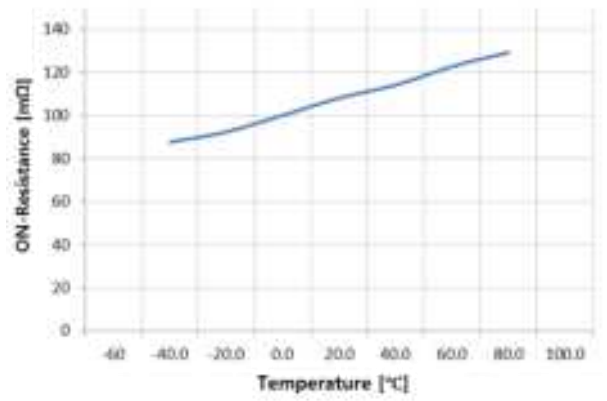

I_L vs. V_{OUT}

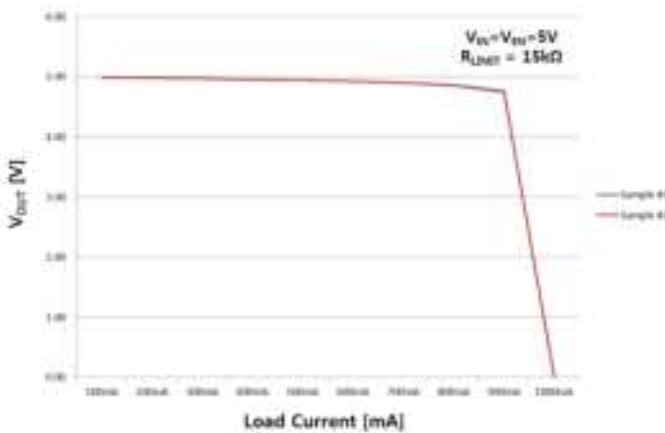

I_L vs. V_{OUT}

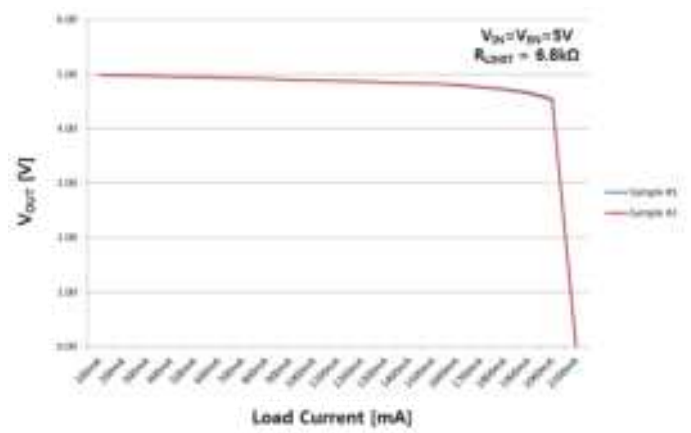

Current Limit Threshold & I_{SC} vs. Supply Voltage

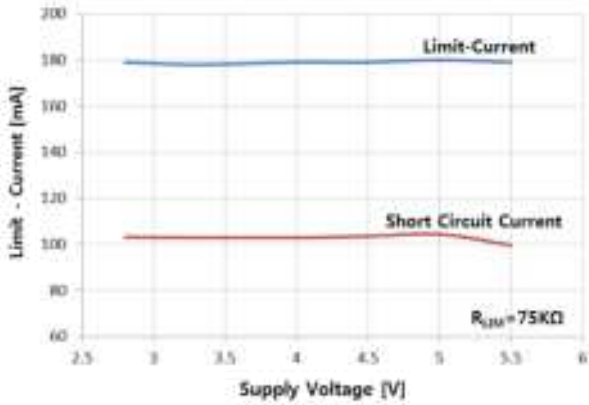

Current Limit Threshold & I_{SC} vs. Temperature

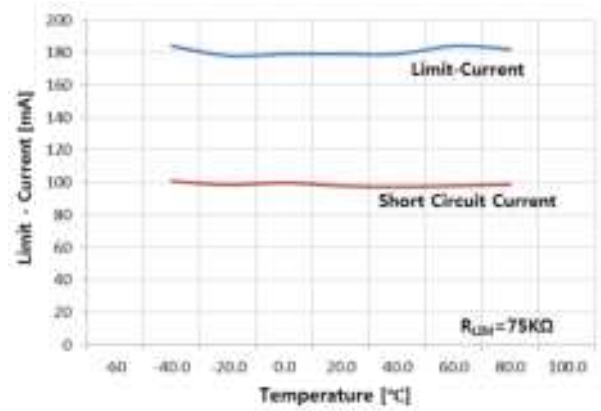

Current Limit Threshold & I_{SC} vs. Supply Voltage

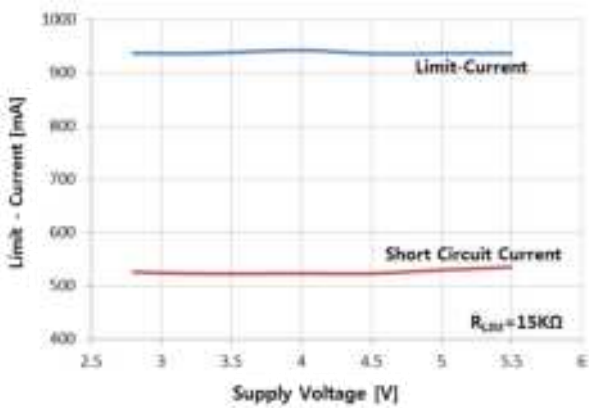

Current Limit Threshold & I_{SC} vs. Temperature

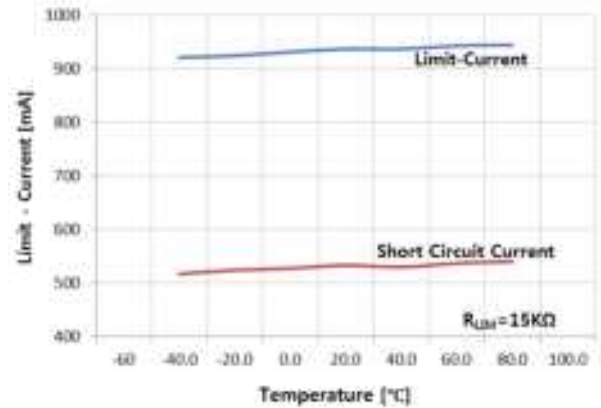

Current Limit Threshold & I_{SC} vs. Supply Voltage

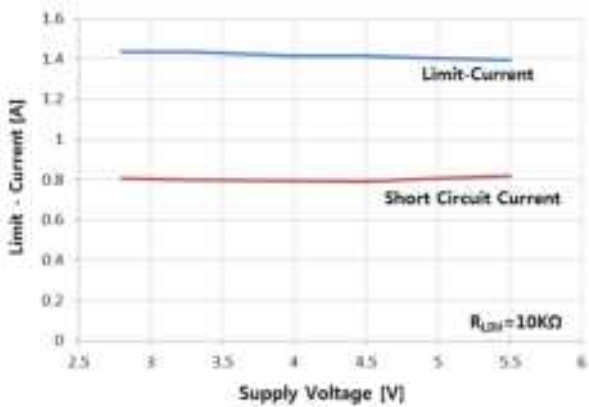

Current Limit Threshold & I_{SC} vs. Temperature

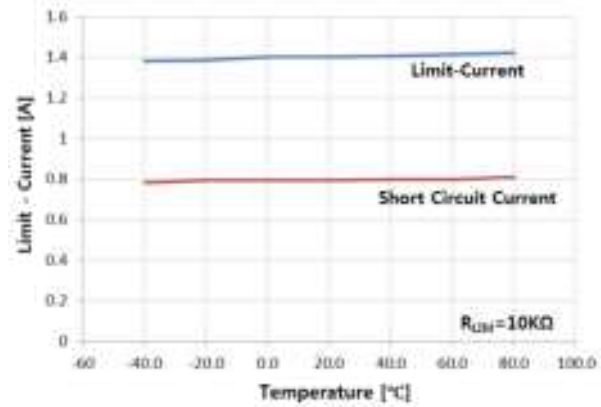

Current Limit Threshold & I_{SC} vs. Supply Voltage

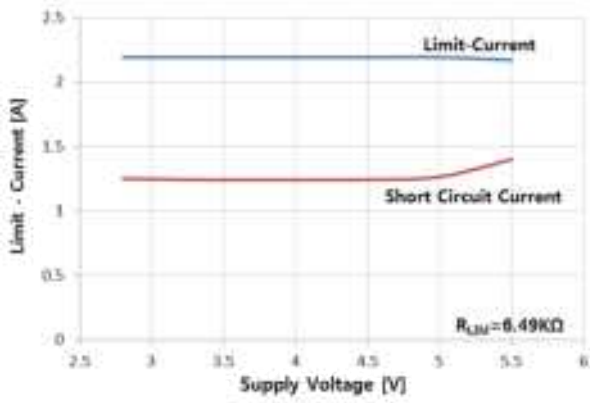

Current Limit Threshold & I_{SC} vs. Temperature

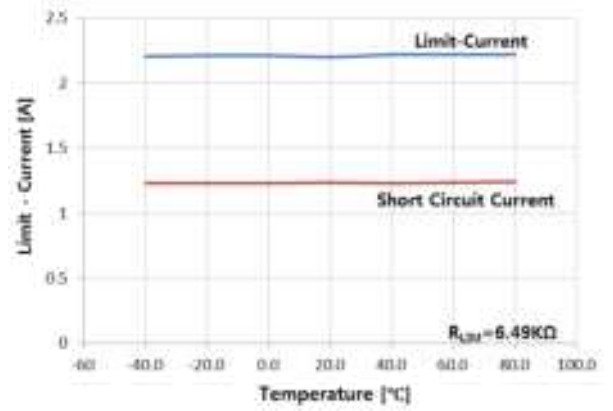

TYPICAL OPERATING CHARACTERISTICS

- $V_{IN}=5V$, $V_{EN}=5V$, $T_A=25^\circ C$, $R_{LIMIT}=12K\Omega$, $C_{IN}=1\mu F$, $C_L=10\mu F$ unless otherwise noted.

Turn – ON

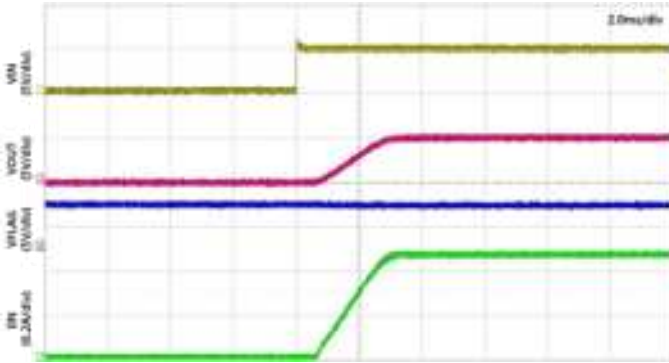

Turn – OFF

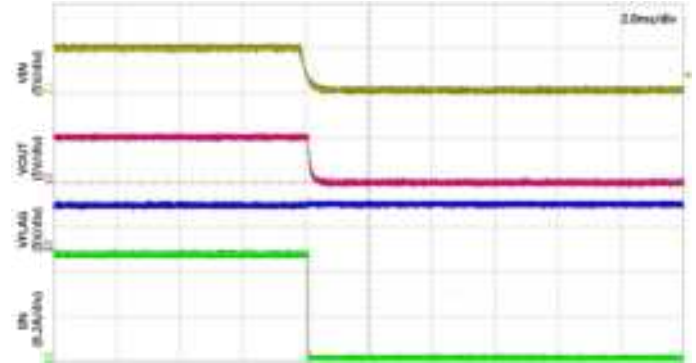

Inrush Current Response

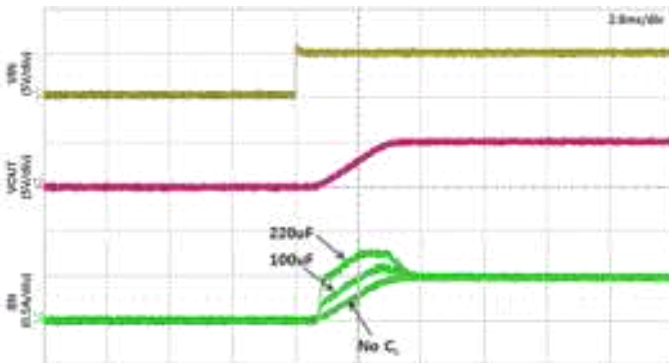

Short Circuit Response

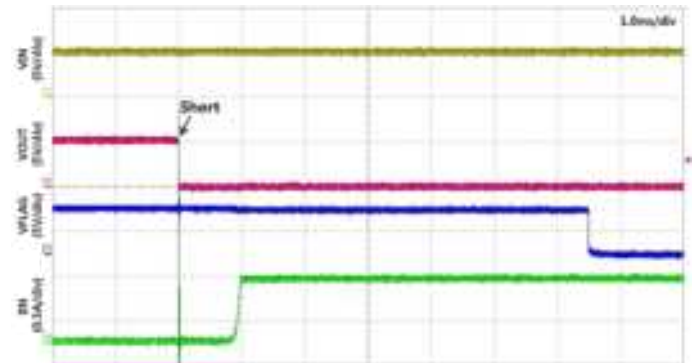

Enable into Short Circuit

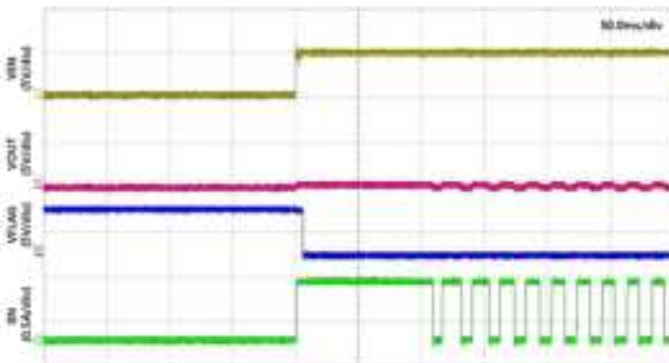

Disable from Short Circuit

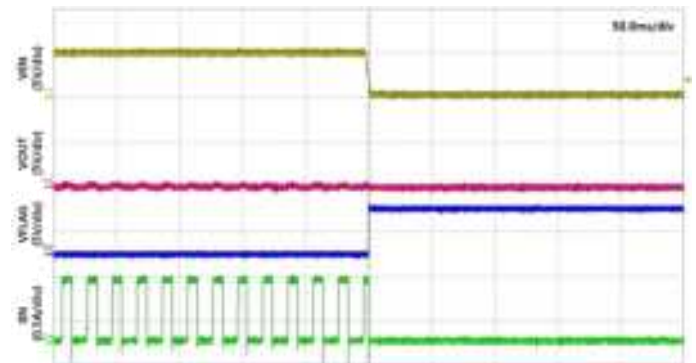

UVLO

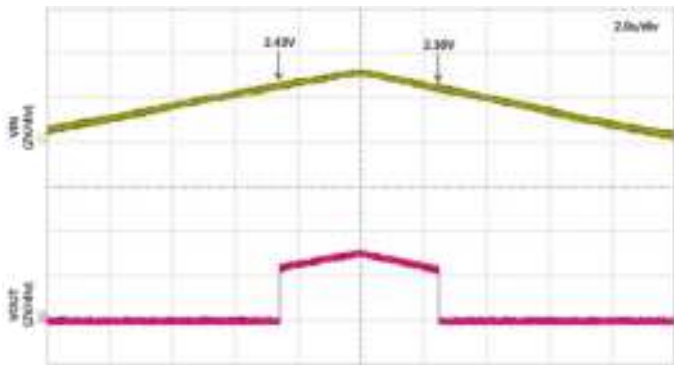

Enable Threshold

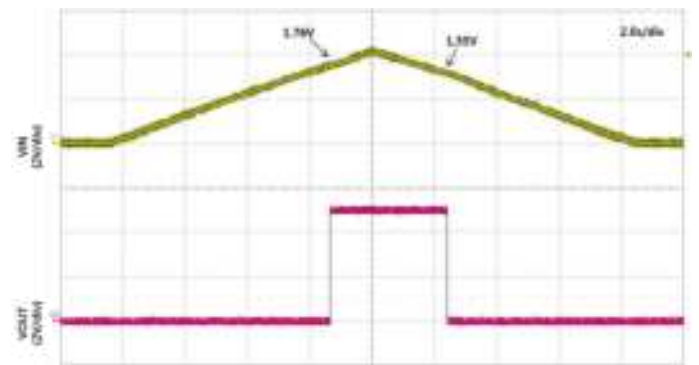

Thermal Shutdown

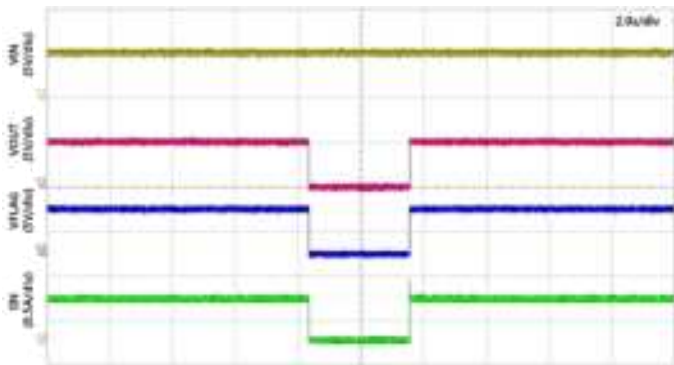

Function Description

Supply Filtering

A 0.1uF to 10uF bypass capacitor from IN pin to GND pin is recommended to control power supply transients. Recommend X5R or X7R dielectrics when using ceramic capacitors for input/output. Without this bypass capacitor, an output short can cause ringing from supply lead inductance on the input and damage the internal control circuitry.

Input or output transients must not exceed the absolute maximum supply voltage ($V_{IN(MAX)} = 6.5V$).

Power Dissipation

The device's junction temperature depends on several factors such as the load, PCB layout, ambient temperature, and package type. Equations that can be used to calculate power dissipation of each channel and junction temperature are found below:

$$P_D = R_{DS(ON)} \times I_{OUT}^2$$

Total power dissipation of the device will be the summation of P_D for both channels. To relate this to junction temperature, the following equation can be used:

$$T_J = P_D \times \theta_{JA} + T_A$$

Where:

T_J = Junction temperature

T_A = Ambient temperature

θ_{JA} = Thermal resistance of the package

Enable/Shutdown

The EN control pin must be driven to a logic high or logic low for a clearly defined signal input. Floating these control lines may cause unpredictable operation.

Fault Flag

The FLG signal is open-drained output of N-channel MOSFET, the FLG output is pulled low to signal the following fault conditions: output short to GND and thermal shutdown.

Soft-Start Condition

The TJ2242 has high impedance when off, which gradually shifts to low impedance as the chip turns on. This prevents an inrush current from causing voltage drops that result from charging a capacitive load and can pull the USB voltage bus below specified levels. This satisfies the USB voltage droop requirements for bus-powered applications.

The TJ2242 can provide inrush current limiting for applications with large load capacitances where $C_L > 10\mu F$.

Current Sense

A sense MOSFET monitors the current supplied to the load. The sense MOSFET measures current more efficiently than conventional resistance methods. When an overload or short circuit is encountered, the current-sense circuitry sends a control signal to the driver. The driver in turn reduces the gate-source voltage and drives the power MOSFET into its saturation region, which switches the output into a constant-current mode and holds the current constant while varying the voltage on the load. When operating region of power MOSFET is close to saturation region, ON resistance of power MOSFET is made significantly increase. It can cause the operation of thermal protection before reaching to current limit level.

Over-Current and Short-Circuit Protection

The TJ2242 features an over-current protection circuitry to protect the device against overload conditions. The current limit threshold is user programmable via an external resistor. The TJ2242 provides an

adjustable current limit threshold between 200mA and 2.25A(Typ.). The recommended 1% resistor range for R_{LIMIT} is 6.35k Ω to 75k Ω . It protects the output MOSFET switch from damage due to undesirable short circuit conditions of excess inrush current often encountered during hot plug-in. Also the TJ2242 is including a fold back current limiting function for short-circuit protection. In the event of an output short-circuit condition, the current flowing through the switch is about 40~50% smaller than the current limit threshold(I_{LIM}). A short circuit current limit condition will signal the error flag. These features can protect the load system effectively at any accidental circumstances.

The following equations can be used to calculate the resulting current limit threshold and short circuit current for determining external resistor value (R_{LIMIT}). However, in the equation do not considered tolerance factors like that processing variation from part to part, as well as variations in the voltage at IN and OUT, plus the operating temperature. Therefore current limit may be operated more than the calculated value.

When input voltage oscillates by external factors, input current also oscillates. It can cause the malfunction to current limit operation. In case of the peak value of current is increased more than set limit value, the current limit function of TJ2242 operates. Then the RMS value of the current limit may operate lower than a targeted level.

Equations for current limit:

$$I_{LIM}(Typ) = 13759.5 \times R_{LIMIT}[k\Omega]^{-0.98}$$

$$I_{LIM}(Min) = I_{LIM}(Typ)[mA] \times 0.98 - 90$$

$$I_{LIM}(Max) = I_{LIM}(Typ)[mA] \times 1.02 + 90$$

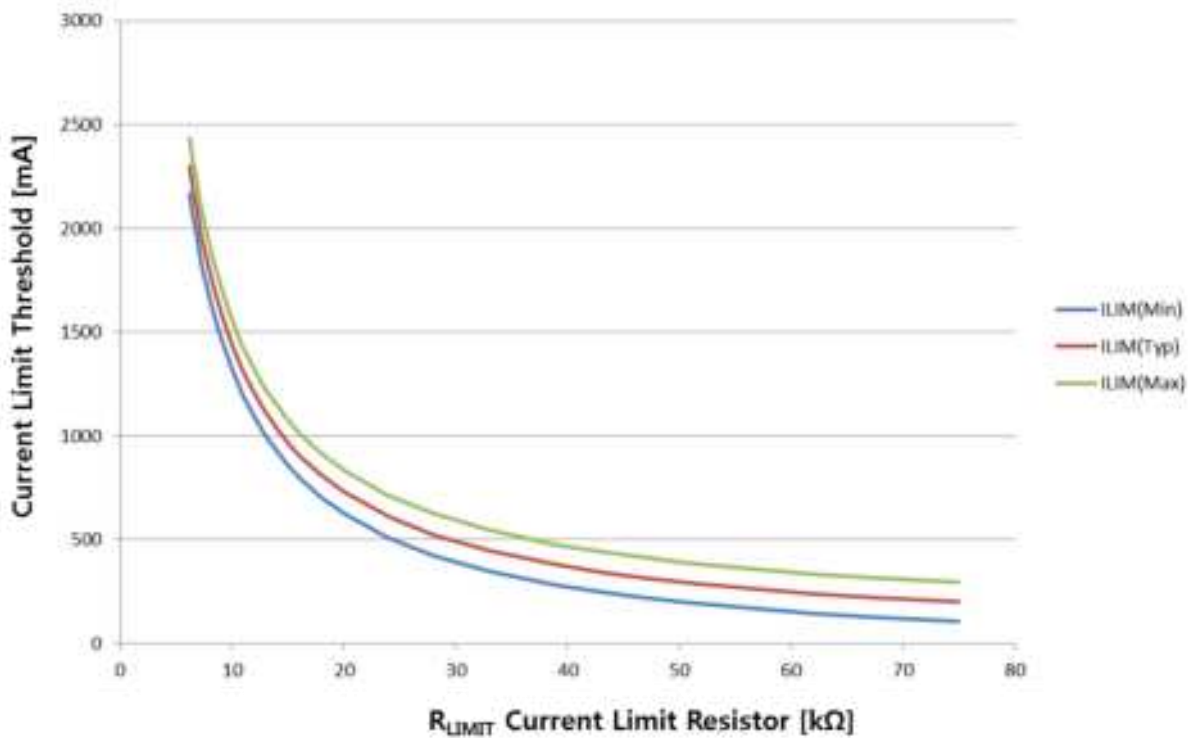

Table 1. Recommended R_{ILIM} Resistor Selections

$R_{ILIM}(k\Omega)$	Actual Limits(mA)			
	$I_{LIM(MIN)}$	$I_{LIM(NOM)}$	$I_{LIM(MAX)}$	$I_{SC(nom)}$
75.00	106	200	294	112
49.59	204	300	396	168
36.97	302	400	498	224
29.45	400	500	600	280
24.45	498	600	702	336
20.89	596	700	804	392
18.23	694	800	906	448
16.16	792	900	1008	504
14.52	890	1000	1110	560
13.17	988	1100	1212	616
12.05	1086	1200	1314	672
11.11	1184	1300	1416	728
10.30	1282	1400	1518	784
9.60	1380	1500	1620	840
8.99	1478	1600	1722	896
8.45	1576	1700	1824	952
7.97	1674	1800	1926	1008
7.54	1772	1900	2028	1064
7.16	1870	2000	2130	1120
6.81	1968	2100	2232	1176
6.49	2066	2200	2334	1232
6.35	2115	2250	2385	1260

Thermal Shutdown Protection

Thermal shutdown limits the TJ2242 junction temperature and protects the device from damage as a result of overheated.

Thermal protection turns off when the TJ2242's junction temperature 150°C reached, allowing it to cool down until 130°C. The TJ2242 is reactivated when a junction temperature drops to approximately 130°C. It depends on the power dissipation, thermal resistance, and ambient temperature.

Under Voltage Lockout

Under Voltage Lockout (UVLO) prevents the output MOSFET from turning on until V_{IN} exceeds approximately 2.45V. After the switch turns on, if the voltage drops below 2.35V typically, UVLO shuts off the output MOSFET. Under voltage detection functions only works when the switch is enabled.

Auto Discharge Function

When the switch is turned off from disable control input, UVLO or OTP, auto discharge function turns on. The auto-discharge function quickly lowers the V_{OUT} to the ground level by releasing the electrical charge accumulated in the external capacitor.

Reverse Current Protection

The Reverse Current Protection circuit prevents the reverse current from V_{OUT} pin to V_{IN} pin when V_{OUT} becomes higher than V_{IN} .

Printed Circuit Layout

The power circuitry of USB printed circuit boards requires a customized layout to maximize thermal dissipation and to minimize voltage drop and EMI.