

TOSHIBA Photocoupler GaAlAs Ired & Photo-IC

TLP114A

- Digital Logic Isolation.
- Line Receiver.
- Power Supply Control Feedback Control.
- Switching Power Supply.
- Transistor Invertor.

The TOSHIBA mini flat coupler TLP114A is a small outline coupler, suitable for surface mount assembly. TLP114A consists of a high output power GaAlAs light emitting diode, optically coupled to a high speed detector of one chip photodiode-transistor.

- Isolation voltage: 3750 Vrms (min.)
- Switching speed: $t_{pHL} = 0.8\mu s$, $t_{pLH} = 0.8\mu s$ (max.)
($R_L = 1.9 k\Omega$)
- TTL compatible
- UL recognized: UL1577, file no. E67349

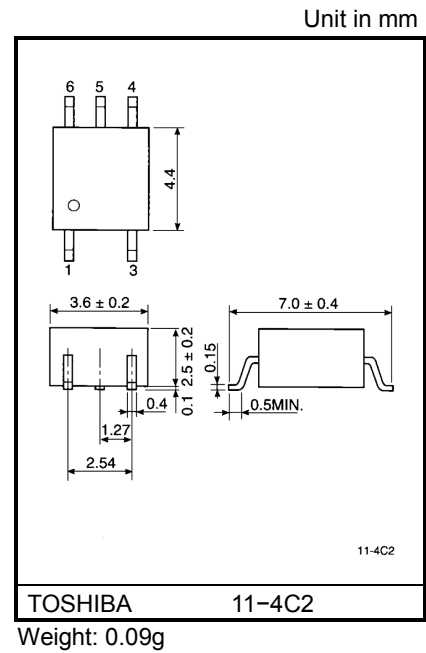

Pin Configuration (top view)

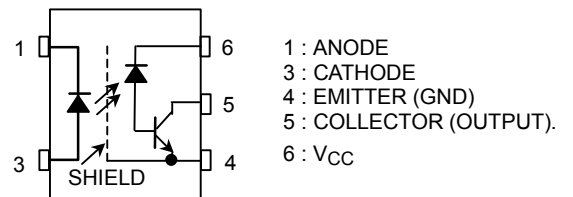

Schematic

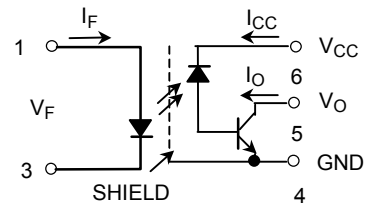

Maximum Ratings (Ta = 25°C)

Characteristic		Symbol	Rating	Unit
LDE	Forward current (Note 1)	I _F	20	mA
	Pulse forward current (Note 2)	I _{FP}	40	mA
	Peak transient forward current (Note 3)	I _{FPT}	1	A
	Reverse voltage	V _R	5	V
Detector	Output current	I _O	8	mA
	Peak output current	I _{OP}	16	mA
	Supply voltage	V _{CC}	-0.5~30	V
	Output voltage	V _O	-0.5~20	V
	Output power dissipation (Note 4)	P _O	100	mW
Operating temperature range		T _{opr}	-55~100	°C
Storage temperature range		T _{stg}	-55~125	°C
Lead solder temperature(10 sec.)		T _{sol}	260	°C
Isolation Voltage (AC, 1 min., R.H. ≤ 60%) (Note 5)		BV _S	3750	Vrms

(Note 1) Derate 0.36mA / °C above 70°C.

(Note 2) 50% duty cycle, 1ms pulse width.

Derate 0.72mA / °C above 70°C.

(Note 3) Pulse width ≤ 1μs, 300pps.

(Note 4) Derate 1.8mW / °C above 70°C.

Electrical Characteristics (Ta = 25°C)

Characteristic		Symbol	Test Condition	Min.	Typ.	Max.	Unit
LDE	Forward voltage	V_F	$I_F = 16\text{mA}$	1.22	1.42	1.72	V
	Forward voltage temperature coefficient	$\Delta V_F / \Delta T_a$	$I_F = 16\text{mA}$	—	-2	—	mV / °C
	Reverse current	I_R	$V_R = 3\text{V}$	—	—	10	μA
	Capacitance between terminals	C_T	$V_F = 0, f = 1\text{MHz}$	—	30	—	pF
Detector	High level output current	$I_{OH(1)}$	$I_F = 0\text{mA}, V_{CC} = V_O = 5.5\text{V}$	—	3	500	nA
		$I_{OH(2)}$	$I_F = 0\text{mA}, V_{CC} = 30\text{V}$ $V_O = 20\text{V}$	—	—	5	μA
		I_{OH}	$I_F = 0\text{mA}, V_{CC} = 30\text{V}$ $V_O = 20\text{V}, T_a = 70^\circ\text{C}$	—	—	50	
	High level supply current	I_{CCH}	$I_F = 0\text{mA}, V_{CC} = 30\text{V}$	—	0.01	1	μA
Coupled	Current transfer ratio	I_O / I_F	$I_F = 16\text{mA}, V_{CC} = 4.5\text{V}$ $V_O = 0.4\text{V}$	20	—	—	%
	Low level output voltage	V_{OL}	$I_F = 16\text{mA}, V_{CC} = 4.5\text{V}$ $I_O = 2.4\text{mA}$	—	—	0.4	V
	Isolation resistance	R_S	R.H. $\leq 60\%$, $V_S = 500\text{V}$ (Note 5)	5×10^{10}	10^{14}	—	Ω
	Stray capacitance between input to output	C_S	$V_S = 0, f = 1\text{MHz}$ (Note 5)	—	0.8	—	pF

Switching Characteristics (Ta = 25°C, VCC = 5V)

Characteristic	Symbol	Test Circuit	Test Condition	Min.	Typ.	Max.	Unit
Propagation delay time (H → L)	t_{pHL}	1	$I_F = 0 \rightarrow 16\text{mA}$ $V_{CC} = 5\text{V}, R_L = 1.9\text{k}\Omega$	—	—	0.8	μs
Propagation delay time (L → H)	t_{pLH}	1	$I_F = 16 \rightarrow 0\text{mA}$ $V_{CC} = 5\text{V}, R_L = 1.9\text{k}\Omega$	—	—	0.8	μs
Common mode transient immunity at high output level	C_{MH}	2	$I_F = 0\text{mA}$, $V_{CM} = 400\text{V}_{p-p}$ $R_L = 4.1\text{k}\Omega$	5000	10000	—	V / μs
Common mode transient immunity at low output level	C_{ML}	2	$I_F = 16\text{mA}$, $V_{CM} = 400\text{V}_{p-p}$ $R_L = 4.1\text{k}\Omega$	-5000	-10000	—	V / μs

(Note 5) Device considered a two-terminal device: Pins 1 and 3 shorted together, and pins 4, 5 and 6 shorted together.

(Note 6) Maximum electrostatic discharge voltage for any pins: 100V(C=200pF, R=0)

Test Circuit 1: Switching Time Test Circuit

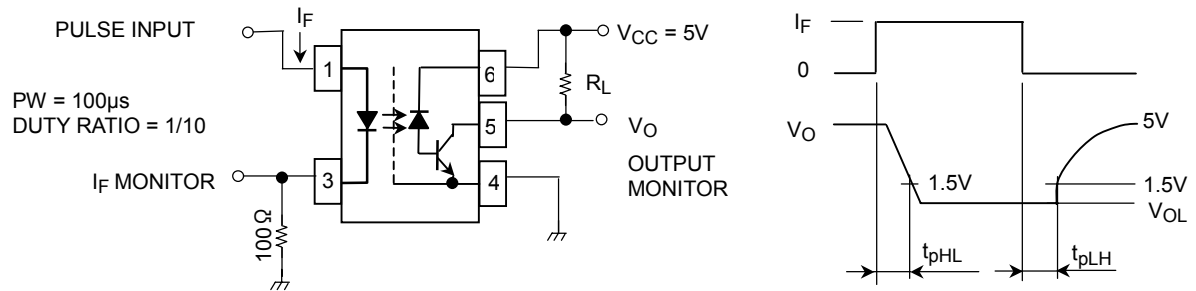

Test Circuit =2: Common Mode Transient Immunity Test Circuit

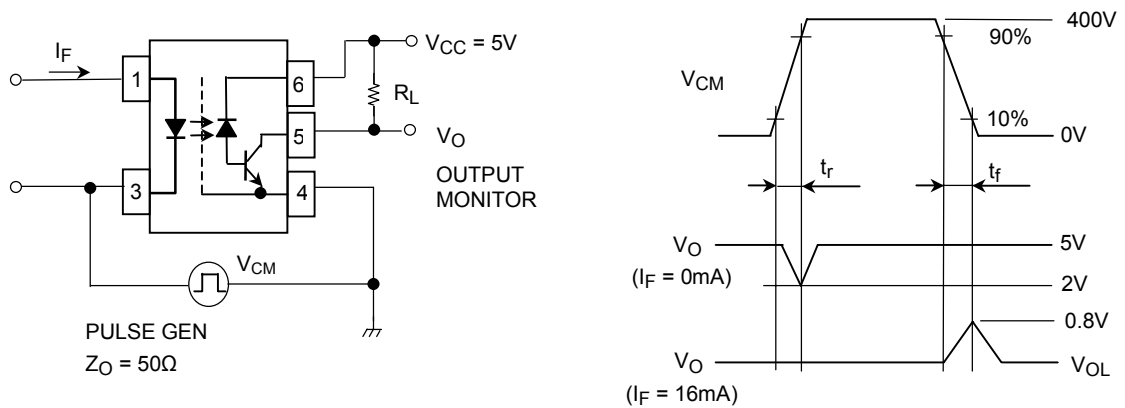

$$CM_H = \frac{320(V)}{t_r(\mu s)}, \quad CM_L = \frac{320(V)}{t_r(\mu s)}$$

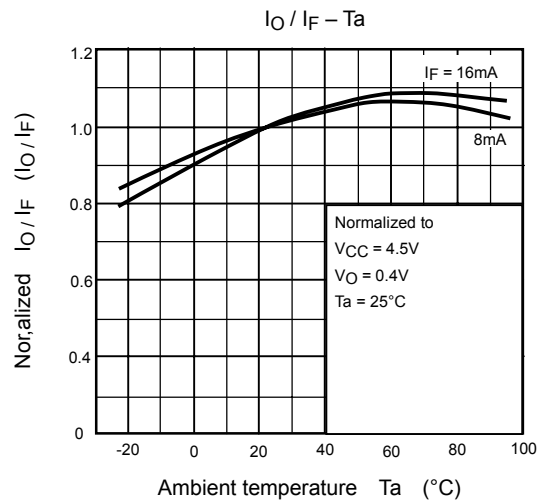
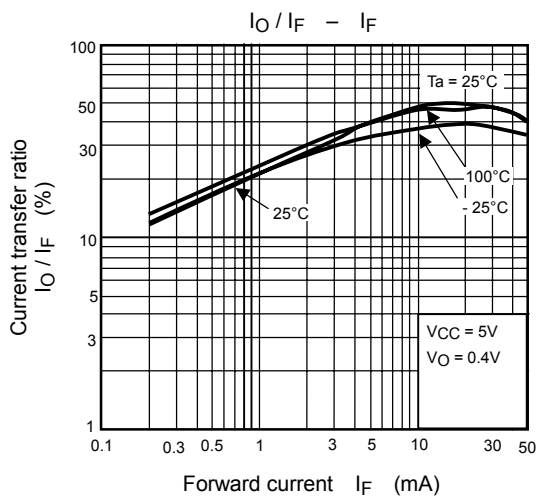
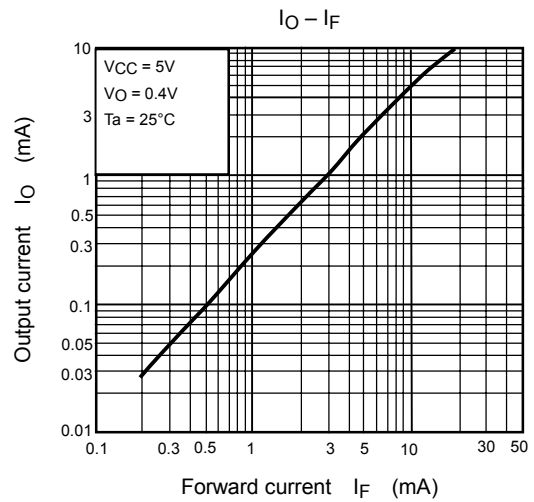
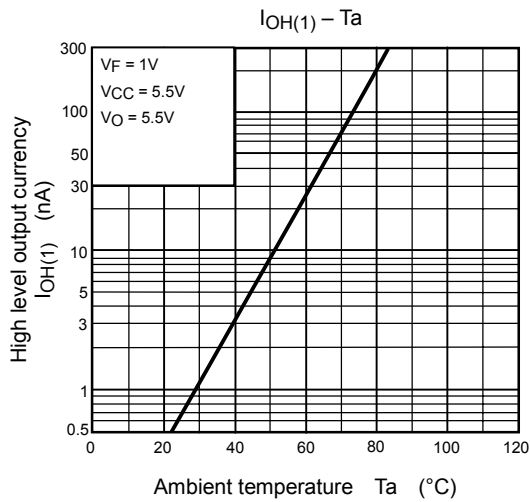
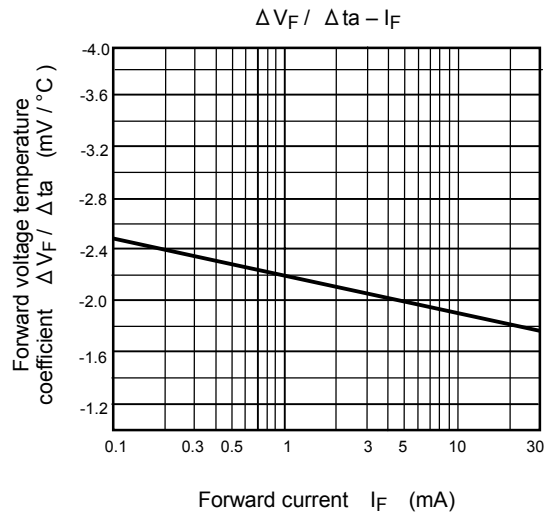
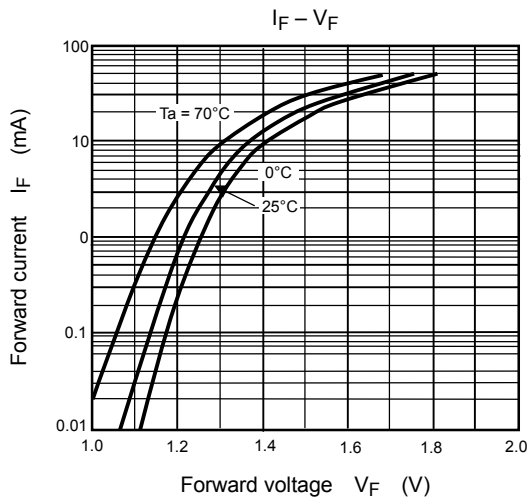

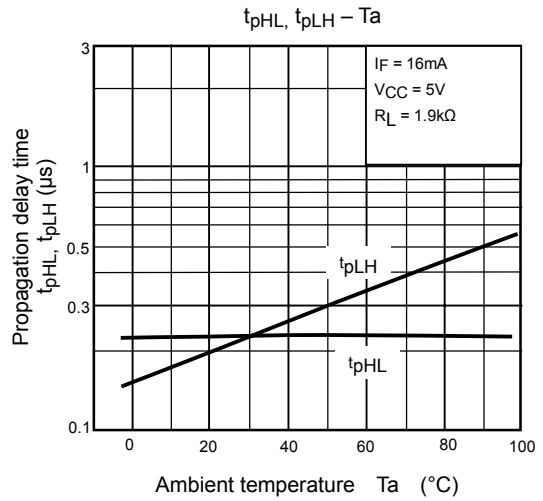
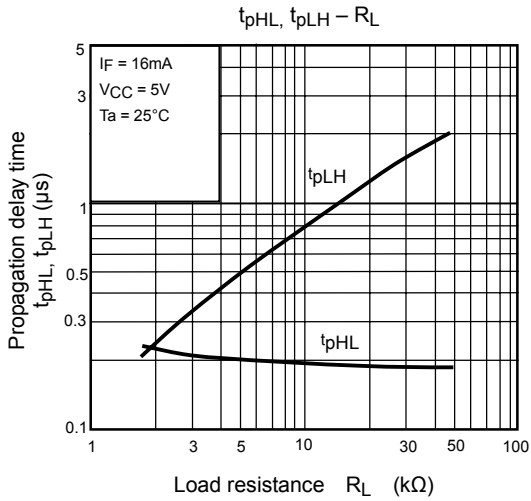
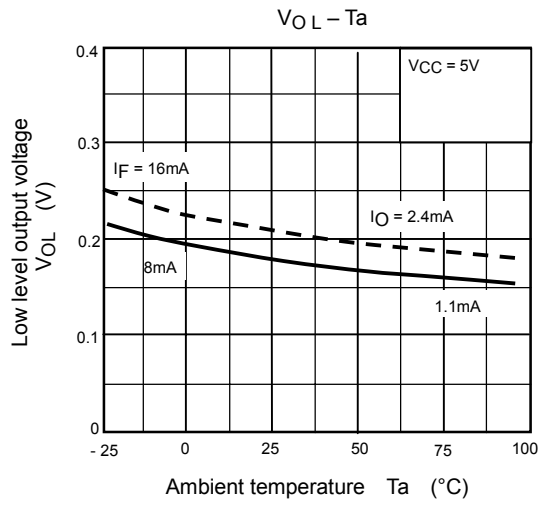
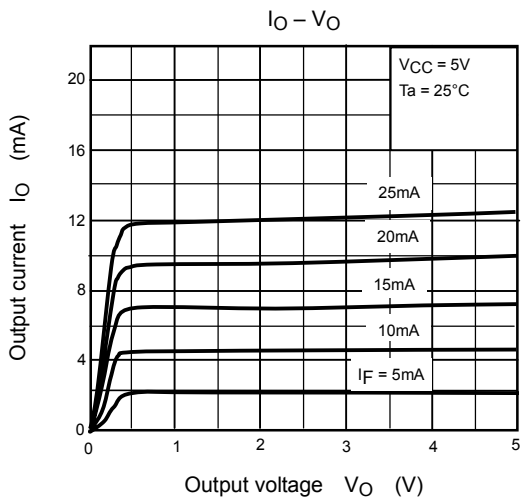

RESTRICTIONS ON PRODUCT USE

000707EBC

- TOSHIBA is continually working to improve the quality and reliability of its products. Nevertheless, semiconductor devices in general can malfunction or fail due to their inherent electrical sensitivity and vulnerability to physical stress. It is the responsibility of the buyer, when utilizing TOSHIBA products, to comply with the standards of safety in making a safe design for the entire system, and to avoid situations in which a malfunction or failure of such TOSHIBA products could cause loss of human life, bodily injury or damage to property.
In developing your designs, please ensure that TOSHIBA products are used within specified operating ranges as set forth in the most recent TOSHIBA products specifications. Also, please keep in mind the precautions and conditions set forth in the "Handling Guide for Semiconductor Devices," or "TOSHIBA Semiconductor Reliability Handbook" etc..
- The TOSHIBA products listed in this document are intended for usage in general electronics applications (computer, personal equipment, office equipment, measuring equipment, industrial robotics, domestic appliances, etc.). These TOSHIBA products are neither intended nor warranted for usage in equipment that requires extraordinarily high quality and/or reliability or a malfunction or failure of which may cause loss of human life or bodily injury ("Unintended Usage"). Unintended Usage include atomic energy control instruments, airplane or spaceship instruments, transportation instruments, traffic signal instruments, combustion control instruments, medical instruments, all types of safety devices, etc.. Unintended Usage of TOSHIBA products listed in this document shall be made at the customer's own risk.
- Gallium arsenide (GaAs) is a substance used in the products described in this document. GaAs dust and fumes are toxic. Do not break, cut or pulverize the product, or use chemicals to dissolve them. When disposing of the products, follow the appropriate regulations. Do not dispose of the products with other industrial waste or with domestic garbage.
- The products described in this document are subject to the foreign exchange and foreign trade laws.
- The information contained herein is presented only as a guide for the applications of our products. No responsibility is assumed by TOSHIBA CORPORATION for any infringements of intellectual property or other rights of the third parties which may result from its use. No license is granted by implication or otherwise under any intellectual property or other rights of TOSHIBA CORPORATION or others.
- The information contained herein is subject to change without notice.

This datasheet has been download from:

www.datasheetcatalog.com

Datasheets for electronics components.