

UT513A Operating Manual



Insulation Resistance Tester

Introduction

Uni-Trend Model UT513A Insulation Resistance Tester (hereafter, "the Meter") is a handheld instrument designed primarily to make resistance/ insulation resistance measurement.

Unpacking the Meter

The Meter includes the following items:

Table 1. Unpacking Inspection

Item	Description	Qty
1	English Operating Manual	1 pc
2	One plug test lead to one alligator clip (Black)	1 pc
3	One-plug test lead to one alligator clip (Green)	1 pc
4	Two-plug test lead to one alligator clip (Red)	1 pc
5	1.5V Battery (LR14)	8 pcs
6	Tool Box	1 pc
7	USB Interface Cable	1 pc
8	Software	1 pc
9	Power adaptor (input voltage 230V, 50/60Hz, 150mA, output DC15V, 1100mA) (optional, available at extra cost)	1 pc

It is recommended to select the specific 8pcs chargeable batteries (LR14) and a charger. In the event you find any missing or damaged part, please contact your dealer immediately.

Safety Information

This Meter complies with IEC61010 safety measurement requirement: Pollution Degree 2, Overvoltage Category(CAT. III 600V) and Double Insulation.

CAT II: Local level, appliance, PORTABLE EQUIPMENT etc., with smaller transient voltage overvoltages than CAT. III

Use the Meter only as specified in this operating manual, otherwise the protection provided by the Meter may be impaired.

Danger identifies conditions and actions that pose hazard(s) to the user.

Warning alerts the user to avoid electric shock.

Caution identifies conditions and actions that may damage the Meter and affect accurate measurement.

Operating Caution identifies conditions that user needs to take extra care during operating the Meter

Danger

Use of instrument in a manual not specified by the manufacturer may impair safety features/protection provided by the equipment. Read the following safety information carefully before using or servicing the instrument.

- Do not apply more than 600V.
- Do not use the Meter around explosive gas, vapor or dust.
- Do not use the Meter in a wet environment.
- When using the test leads, keep your figures away from the lead contacts. Keep your figures behind the finger guards on the leads.
- Do not use the Meter with any parts or cover removed.
- When carrying out insulation measurement, do not contact the circuit under test.

Warning

- Do not use the Meter if it is damaged or metal part is exposed. Look for cracks or missing plastic.
- Be careful when working above 33V rms, 46.7V ac rms or 70V DC. Such voltages pose a shock hazard.
- Discharge all loading of circuit under test after measuring high voltage.

- Do not change battery when the Meter is in wet environment.
- Place test leads in proper input terminals. Make sure all the test leads are firmly connected to the Meter's input terminals.
- Make sure the Meter is turned off when opening the battery compartment.

Caution

- When performing resistance tests, remove all power from the circuit to be measured and discharge all the power.
- When servicing the Meter, use only the test leads and power adaptor with the same model or identical electrical specifications.
- Do not use the Meter if the battery indicator () shows a battery empty condition. Take the battery out from the Meter if it is not used for a long time.
- Do not use or store the Meter in an environment of high temperature, humidity, explosive, inflammable and strong magnetic field. The performance of the Meter may deteriorate after dampened.
- Soft cloth and mild detergent should be used to clean the surface of the Meter when servicing. No abrasive and solvent should be used to prevent the surface of the Meter from corrosion, damage and accident.
- Dry the Meter before storing if it is wet.

International Electrical Symbols

International symbols on the Meter and in this manual are explained in Table 2.

Table 2. International Electrical Symbols

	Risk of electric shock
	Equipment protected by double or reinforced insulation.
	DC Measurement
	AC Measurement
	Grounding
	See Manual
	Low Battery Indication
	Conforms to Standards of European Union

Battery Saver (Sleep Mode)

The Meter enters the Sleep Mode and blanks the display after 15 minutes' inactivity. This is done to conserve battery power. The Meter comes out of Sleep Mode when ON/OFF button is pressed and hold for 1 second.

Battery Indication

There is a battery indicator shown on the upper left corner of the display. Please refer to Table 3 for detailed explanation.

Table 3. Battery Indication

Battery Indicator	Battery Voltage
	10V or less. It means the battery is empty, don't use the Meter as it cannot guarantee accuracy.
	10V~10.5V. It means the battery is almost empty replacing battery is necessary. Under this status, the Meter can still output 500V and 1000V to measure, the measured accuracy will not be affected.
	10.6V~11.5V
	11.6V or more

When charging battery is applied, the charging battery work mode should be selected at the startup: Press and hold USB button prior to startup, then press down ON/OFF, LCD screen will display CHA or GEN, and select to display CHA by pressing the up/down key, after pressing USB key to confirm, the Meter successfully enters the charging battery work mode. GEN means the general alkaline battery work mode.

The Meter Structure

Below Figure 1 and Table 4 shows the Meter front structure and description

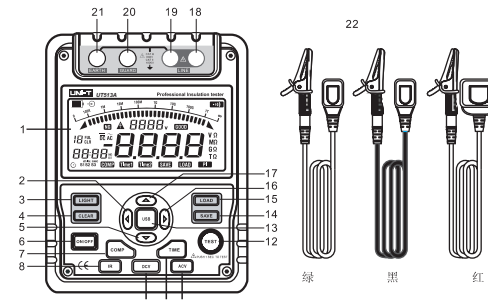

Figure 1. The Meter Front Structure

Table 4. Meter Front Description

1	LCD
2	◀ Arrow Button
3	Emergency Stop
4	Data Clear the Display Backlight Button
5	▼ Arrow Button
6	On/Off Button
7	Compare Button
8	Insulation Resistance Button
9	DC Voltages measurement Button
10	Timer Button.
11	AC Voltages measurement Button
12	Test Button
13	USB Button
14	Data Store Button.
15	Data Recall Button
16	▶ Arrow Button
17	▲ Arrow Button
18	LINE: High voltage input terminal (Connected to two-plug red test lead)
19	High voltage line shielding input terminal (Connected to two-plug red test lead)
20	GUARD: Grounding protection input terminal (Connected to one-plug black test lead)
21	EARTH: High resistance measurement input terminal (Connected to one-plug test lead)
22	Testing leads: Two-plug red test lead to one alligator clip. One-plug black test lead to one alligator clip. One-plug green test lead to one alligator clip.

Below Figure 2 and Table 5 shows the Meter side structure and description

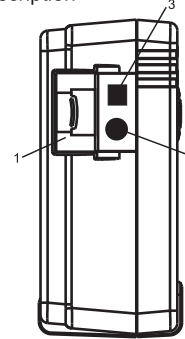

Figure 2. The Meter Side Structure

Table 5. Meter Side Description

1	Safety Shutter
2	Power adaptor Input Terminal
3	USB Port

Display

Table 6 and Figure 3 describe the display.

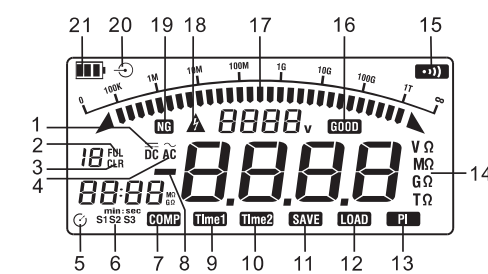

Figure 3. Display

Table 6. Display Description

Number	Meaning
1	Indicator for DC voltage
2	Indicator for data store full
3	Indicator for clearing
4	Indicator for AC voltage
5	Indicator for timer
6	Step symbol
7	Indicates selected pass/fail compare value
8	Indicates for negative reading
9	Timer 1 symbol
10	Timer 2 symbol
11	Data store is on
12	Data recall is on

13	Indicator for polarization index
14	Unit symbols
15	The continuity buzzer is on
16	Compare feature pass
17	Analogue bar graph
18	Risk of electric shock
19	Compare feature fail
20	Indicator for power adaptor
21	Battery life indicator

Key Functions

Table 7. Key Description

ON/OFF	Turn on or off the Meter. Press and hold the button for 1 second to turn the Meter on. Press again to turn off the Meter. The Meter defaults at 500V range and under continuous measurement of insulation resistance when turned on.
LIGHT	Press to turn on/off the backlight.
CLEAR	Press to clear the saved data.
SAVE	Press to store the current measurement value. The Meter can save up to 18 sets. When the stored readings memory is full, the Meter shows FULL and stop storing. Press and hold CLEAR to clear the stored value in order to store the next measurement value.
LOAD	<ul style="list-style-type: none"> Press once to recall the first stored value. Press again to exit Load feature. Load feature can only be used when there is no high voltage output.
▲	<ul style="list-style-type: none"> When the insulation resistance measurement has no testing voltage output, press to select previous voltage range. Under load mode: press to recall the previous stored value.
▼	<ul style="list-style-type: none"> When the insulation resistance measurement has no testing voltage output, press to select next voltage range. Under load mode: press to recall the next stored value.
◀	<ul style="list-style-type: none"> When setting the timer for the measurement of insulation resistance or polarization index, press to decrement the time. The maximum length of time is 15 minutes and 30 seconds, the Meter will automatically carry out measurement. When compare function is enabled for insulation resistance measurement, press to decrement a resistance comparing value. After polarization index measurement, press to display polarization index, TIME 2 and TIME 1 insulation resistance values in sequence.
▶	<ul style="list-style-type: none"> When setting the timer for the measurement of insulation resistance or polarization index, press to increment the time. The maximum length of time is 30 minutes and 30 seconds, the Meter will automatically carry out measurement. When compare function is enabled for insulation resistance measurement, press to increment a resistance comparing value. After polarization index measurement, press to display polarization index, TIME 2 and TIME 1 insulation resistance values in sequence.
USB	<ul style="list-style-type: none"> Press once to start the data transferring to the computer via USB, USB symbol shows on the display. Press again to stop the data transferring to the computer via USB, USB symbol disappears.
COMP	Set a pass / fail limit for insulation tests. The default value is 10MΩ
TIME	Press to step through continuous, timed and polarization index measurements in sequence.
TEST	Press to stop or start an insulation resistance test
IR	Press to initiate insulation resistance measurement
DCV	Press to initiate DC voltage measurement
ACV	Press to initiate AC voltage measurement

Measurement Operation

This section explains how to make measurements.

Press and hold ON/OFF to turn on the Meter, press again to turn off the Meter. The Meter defaults at 500V range and under continuous measurement of insulation resistance when turned on.

A. Measuring Voltage

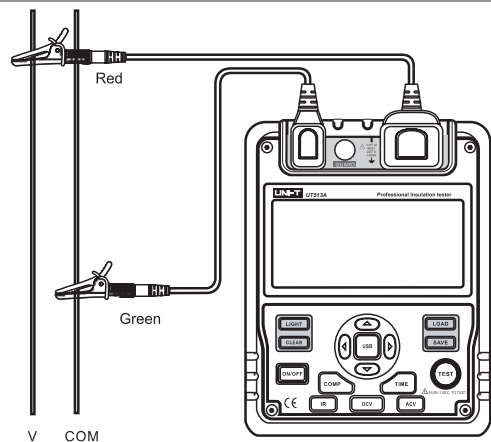

Figure 4. Voltage Measurement

Operating Caution

- To avoid harm to you or damage to the Meter, please do not attempt to measure voltages higher than 600V or 600V rms, although readings may be obtained.
- Special care should be taken when measuring high voltage.

To measure voltage, set up the Meter as Figure 4 and do the following:

1. Press **DCV** or **ACV** button to select DC voltage or AC voltage measurement
2. Insert the red and green test leads into **EARTH** and two **LINE** terminals.
3. When measuring DC voltage, if negative voltage is present on the red test lead, "-" symbol will show on the display.

Note

- When voltage measurement has been completed, disconnect the connection between the testing leads and the circuit under test and remove testing leads away from the input terminals of the Meter.

B. Measuring Insulation Resistance

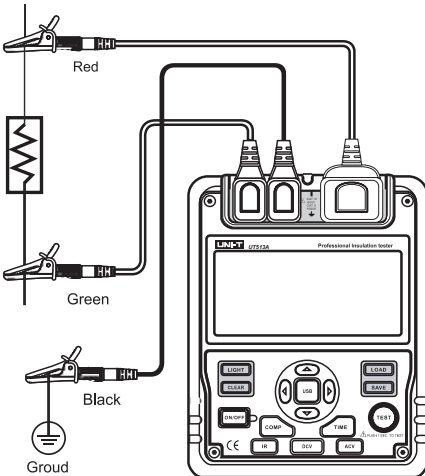

Figure 5. Insulation Resistance Measurement

Operating Caution

- When performing insulation resistance tests, remove all power from the circuit to be measured and discharge all the power.
- Operating the Meter must be very careful as it outputs dangerous voltage during measurement. Must make sure the tested object is firmly clipped, hands are away from the clips, then press **TEST** button to output high voltage.
- Do not short circuit the testing leads during high voltages output or test insulation resistance after high voltages output. This kind of incorrect operating may cause sparking and fire, which damages the Meter and cause personal injury.
- Do not measure over 10 seconds when: measuring resistance < 2MΩ with use of 500V. measuring resistance < 5MΩ with use of 1000V. measuring resistance < 10MΩ with use of 2500V. measuring resistance < 20MΩ with use of 5000V.

To measure insulation resistance, set up the Meter as Figure 5 and do the following:

1. Press **IR** button to select insulation resistance measurement.
2. When there is no testing voltage output, press ▲ and ▼ button to 500V, 1000V, 2500V or 5000V voltage range.
3. When performing insulation resistance tests, remove all power from the circuit to be measured and discharge all the power.
4. Insert the red test lead into two **LINE** terminals, the black one into **GUARD** and the green one into **EARTH**.
5. Connect the red and green alligator clip to the circuit to be measured, negative voltage outputs from **LINE** terminal.
6. Choose one of insulation resistance measurement modes shown as below:

a) Continuous Measurement

- Press **TIME** button to select continuous mode, there is no timer icon on the LCD.
- Press ▲ and ▼ hold **TEST** button for 1 second to carry out begin and output insulation resistance test voltage **TEST** button light up, ▲ blinks on every 0.5 seconds.
- Press **TEST** button to turn off the voltage output, when measurement is completed. **TEST** button lights off, ▲ disappears. The LCD shows the current insulation resistance measurement value.

b) Timed Measurement

- Press **TIME** button to select timed mode, the LCD displays **TIME 1** and ☺ symbols.
- Press ▲ and ▼ buttons to set the time (00:10~15:00). Within 1 minute, the time increment or decrement by every 10 seconds. Afterward, the time increment or decrement by every 30 seconds.
- Then press and hold **TEST** button for 2 second to carry out the measurement. **TIME 1** and ▲ are displayed and blinked on the LCD on every 0.5 seconds.
- When the set time is reached, the test voltage output will be turned off, and the measurement will be automatically stopped. The LCD displays the insulation resistance reading.

c) Polarization Index (PI) Measurement

- Press **TIME** button to select timed mode, the LCD displays **TIME 1** and ☺ symbols.
- Press ▲ and ▼ buttons to set the time (00:10~15:00). Within 1 minute, the time increment or decrement by every 5 seconds. Afterward, the time increment or decrement by every 30 seconds.
- Press **TIME** button again. **TIME 2, PI** and ☺ symbols appear on the LCD.
- Press ▲ and ▼ buttons to set the time (00:15~15:30). Within 1 minute, the time increment or decrement by every 10 seconds. Afterward, the time increment or decrement by every 30 seconds.
- Then press and hold **TEST** button for 2 seconds to carry out timed measurement.
- **TIME 1** and ▲ are displayed and blinked on the LCD on every 0.5 seconds before **TIME 1** set time is reached.
- **TIME 2** and ▲ are displayed and blinked on the LCD on every 0.5 seconds before **TIME 2** set time is reached.
- When the two set time are reached, the test voltage output will be turned off and the measurement will be automatically stopped. The LCD displays the polarization index reading.
- Press ▲, ▼ to step through the polarization index, **TIME 2** and **TIME 2** insulation resistance readings.

Calculation Tips:

PI = 3-minute ~ 10-minute resistance/30-second ~ 1-minute resistance

PI	4 or more	4~2	2.0~1.0	1.0 or less
Standard	The best	Good	Warning	Bad

d) Compare Function

- Press **COMP** button to select compare feature. **COMP** symbol displays on the LCD..
- Press ▲ and ▼ buttons to set the compare value
- You can choose compare from: 10MΩ, 20MΩ, 30MΩ, 40MΩ, 50MΩ, 60MΩ, 70MΩ, 80MΩ, 90MΩ, 100MΩ, 200MΩ, 300MΩ, 400MΩ, 500MΩ, 600MΩ, 700MΩ, 800MΩ, 900MΩ, 1GΩ, 2GΩ, 3GΩ, 4GΩ, 5GΩ, 6GΩ, 7GΩ, 8GΩ, 9GΩ, 10GΩ, 20GΩ, 30GΩ, 40GΩ, 50GΩ, 60GΩ, 70GΩ, 80GΩ, 90GΩ, 100GΩ, 200GΩ, 300GΩ, 400GΩ, 500GΩ, 600GΩ, 700GΩ, 800GΩ, 900GΩ
- Press and hold **TEST** button for 2 seconds to carry out the measurement.
- The **NG** symbol will display if the insulation resistance value is smaller than compare value. Otherwise **GOOD** symbol will be displayed.

Using Power Adaptor

See Figure 6 for the use of power adaptor.

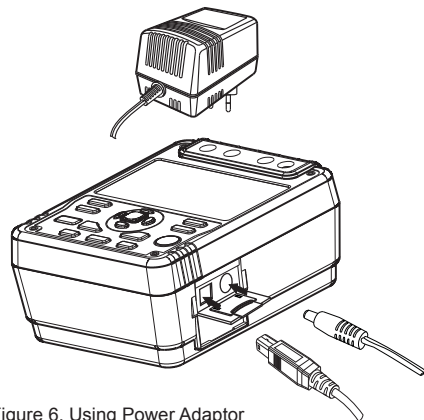

Figure 6. Using Power Adaptor

1. Open the side safety shutter, then you will see there is a power adaptor input terminal.
2. Make sure the Meter is power off and insert the UT513A power adaptor to the input terminal.
3. It is highly recommended to take out all the batteries when you are using the power adaptor.
4. Make sure the Meter is power off when you disconnect the UT513A power adaptor from the Meter.
5. It is highly recommended to use Uni-Trend supplied UT513A power adaptor to avoid dangerous.

Connecting USB Interface

See Figure 7 for USB interface connection.

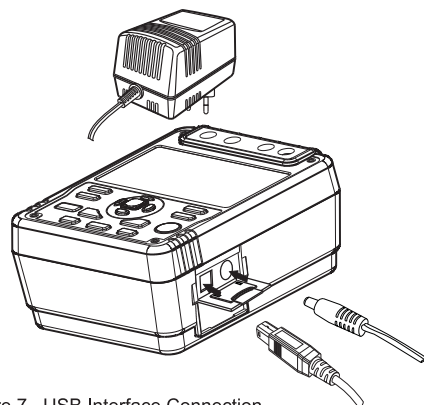

Figure 7. USB Interface Connection

1. Install the included software, the installation guide can be seen from the CD.
2. Open the side safety shutter, then you will see there is a USB port.
3. Insert the included USB cable to the Meter's USB port and the other end to the computer.

Maintenance

This section provides basic maintenance information including battery replacement instruction.

Warning

Do not attempt to repair or service your Meter unless you are qualified to do so and have the relevant calibration, performance test, and service information.

A. General Service

- Periodically wipe the case with a damp cloth and mild detergent. Do not use abrasives or solvents.
- To clean the terminals with cotton bar with detergent, as dirt or moisture in the terminals can affect readings.
- Turn the Meter to OFF when it is not in use.
- Take out the battery when it is not using for a long time.
- Do not use or store the Meter in a place of humidity, high temperature, explosive, inflammable and strong magnetic field.
- If the Meter is wet, dry it before use.

Specifications

Safety and Compliances

Certification	CE
Compliances	IEC 61010 CAT.III 600V overvoltage and double insulation standard

General Specifications

Display (LCD)	Digital: 9999 counts Analog bar graph.
Display Backlight	Bright backlight for clear readings in poorly lighted areas.
Computer connection	Via USB interface.
Data Logging and Recall	18 sets
Autorange	The Meter automatically selects best range
Warning	▲ and red light will on.
Test Voltage	Automatically source the voltage.
COMP Measurement	Use the Compare function to set a pass/fail compare level for the insulation measurements.
PI Measurement	Polarization Index is the ratio of insulation resistance. Preset the timer for two points and the Meter will carry out the measurement automatically.
TIME	To carry out measurement by setting a specified time within 15 minutes.
Overloading	Display OL on insulation resistance range
Battery Indicator	Display [] [] [] [] []
Icon Display	Equips with function and battery indicator icons.
Current Consumption	Maximum: around 1.0A Average: around 20mA
Operating Temperature	-10°C~40°C (14°F~104°F)
Storage Temperature	-20°C~60°C (-4°F~152°F)
Relative Humidity	≤ 85% @ 0°C~40°C below; ≤ 90% @ -20°C~60°C
Battery Type	8pcs of 1.5V (LR14) batteries or power adaptor (input voltage 230V, 50/60Hz, 150mA, input DC15V, 1.0A). Power adaptor is optionally at extra cost.
Dimensions (HxW xL)	202 x 155 x 94 mm
Weight	Approx. 2kg (including battery)

Accuracy Specifications

Accuracy: ± (% of reading) + [number of least significant digits], guarantee for 1 year.
Operating temperature: 18°C~28°C
Relative humidity: 45~75%RH

A. Voltage Measurement

	DC Voltage	AC Voltage
Measurement Range	±30 ~ ±600V	30V~600V (50/60Hz)
Resolution		1V
Accuracy	± (2%+3)	

B. Insulation Resistance Measurement

Output Voltage	500V	1000V	2500V	5000V
Display Range	0.0MΩ~20GΩ	0.0MΩ~40GΩ	0.0MΩ~100GΩ	0.0MΩ~1000GΩ
Open Circuit Voltage	DC 500V 0%~+20%	DC1000V 0%~+20%	DC 2500V 0%~+20%	DC5000V 0%~+20%
Test Current	1mA~1.2mA @ 500kΩ	1mA~1.2mA @ 1MΩ	1mA~1.2mA @ 2.5MΩ	1mA~1.2mA @ 5MΩ
Accuracy	0.0MΩ~99.9MΩ: ±(3%+5) 100MΩ~9.99GΩ: ±(5%+5) 10.0GΩ~20.0GΩ: ±(10%+5)	0.0MΩ~99.9MΩ: ±(3%+5) 100MΩ~9.99GΩ: ±(5%+5) 10.0GΩ~40.0GΩ: ±(10%+5)	0.0MΩ~99.9MΩ: ±(3%+5) 100MΩ~9.99GΩ: ±(5%+5) 10.0GΩ~100GΩ: ±(10%+5)	0.0MΩ~99.9MΩ: ±(3%+5) 100MΩ~9.99GΩ: ±(5%+5) 10.0GΩ~99.9GΩ: ±(10%+5) Above 100GΩ: [±(20%+5) Humidity:Below 50%]
Short Circuit	Maximum than 2.0mA			

Operating Caution

At any output voltage, when the tested resistance is less than 10MΩ, the testing time cannot exceed 10 seconds continuously.

Manufacturer:
Uni-Trend Technology (China) Limited
No 6, Gong Ye Bei 1st Road
Songshan Lake National High-Tech Industrial
Development Zone, Dongguan City
Guangdong Province
China
Postal Code:523 808
Headquarters:
Uni-Trend Group Limited
Rm901, 9/F, Nanyang Plaza
57 Hung To Road
Kwun Tong
Kowloon, Hong Kong
Tel: (852) 2950 9168
Fax: (852) 2950 9303
Email: info@uni-trend.com
http://www.uni-trend.com

B. Replacing the Battery

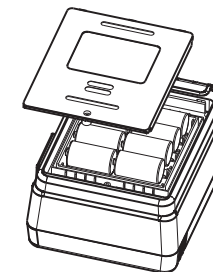

Figure 8. Battery Replacement

Warning

To avoid electric shock, remove all the test leads from the Meter when replacing the batteries.

Operating Caution

- Don't mix to use old and new batteries.
- Be careful the polarity is correct when installing batteries.
- Do not use the Meter if the battery indicator ([]) shows a battery empty condition.
- Do you carry out measuring during the battery compartment is open.

Follow Figure 8 and proceed as follows to replace the battery:

- Turn the Meter to OFF and remove all connections from the terminals.
- Remove the screw from the battery compartment, and separate the battery compartment from the case bottom.
- Replace with 8pcs of new 1.5V (LR14) batteries.
- Rejoin the case bottom and battery compartment, and reinstall the screw.

END

This operating manual is subject to change without notice.