

Preface

Dear users:

Hello! Thanks for you choosing the brand new UNI-T device. In order to use the instrument correctly, please read the manual thoroughly and especially the Safety Notes part before using the device.

If you have read through the manual, you are recommended to keep the manual properly with the instrument together or at the place you can read anytime in order to read it in the process of future use.

Contents

Item	Page
Chapter1 Safety Information.....	1
Safety Terms and Symbols.....	1
General Safety Overview.....	2
Chapter2 UTD1000L Series Oscilloscope Overview	4
UTD1000L Series Oscilloscope Introduction	4
UTD1000L Series Oscilloscope Accessories.....	5
UTD1000L Series Oscilloscope Key Features.....	5
Chapter3 Connections to the Oscilloscope.....	6
General Check.....	6
Checking for any damage due to the transit.....	6
Checking the Accessories.....	6
Checking the Whole Oscilloscope.....	7
Connection Interfaces.....	7
Compensation Output Connection.....	8
Front Panel and Keypad.....	8
Chapter 4 Using Basic Oscilloscope Functions.....	12
About the Chapter.....	12
Powering on the Oscilloscope.....	12

Item	Page
Describing the Display.....	12
Resetting the Oscilloscope.....	14
Using Functional Menus.....	14
Hiding Menus.....	15
Making Connections for Probe Compensation	15
Compensating the Probe.....	12
Setting Vertical & Horizontal Systems and Trigger Level Manually.....	17
Vertical System.....	17
Horizontal System.....	18
Autoset for Waveform Display.....	19
Full Autoset for Input Signal.....	20
Run/Stop Data Acquisition.....	21
Setting Frequency Counter.....	22
Adjusting Screen Intensity.....	22
Saving Bitmap.....	23
Using Online Help.....	23
Setting Single Trigger	24

Item	Page
Viewing Oscilloscope Status.....	24
Checking Oscilloscope System Information.....	26
Making Auto Measurements.....	26
Measuring All parameters.....	26
Using AVG Mode for Smoothing Waveforms.....	29
Using Peak Detect Mode for Pulse Peak Display.....	29
Observing Waveforms with use of Persistence.....	30
Selecting AC Coupling.....	30
Inverting the Waveform Display.....	31
Autoset for Signals with DC Offset.....	32
Chapter 5 Using the Multimeter.....	35
About the Chapter.....	35
Connections to the Multimeter.....	35
Display Indicators.....	35
Making Multimeter Measurements.....	36
Measuring Resistance.....	36
Testing Diodes.....	37

Item	Page
Testing for Continuity.....	37
Measuring Capacitance.....	38
Measuring DC Voltage.....	38
Measuring AC Voltage.....	39
Measuring DC Current with UTD1000CL.....	39
Measuring AC Current with UTD1000CL.....	41
Measuring DC Current with UTD1000DL.....	43
Measuring AC Current with UTD1000DL.....	47
Data Hold.....	51
Making Relative Measurement.....	51
Selecting Auto/Manual Ranging.....	52
Chapter 6 Using the Oscilloscope in Details.....	53
About the Chapter.....	53
Setting Vertical System.....	53
UTD1000CL Channel Setup.....	53
UTD1000DL Channel Setup.....	56
Setting Probe Factor.....	59

Item	Page
Setting Horizontal System.....	59
Changing Timebase.....	59
Moving Waveforms Horizontally.....	59
Zooming in/out Waveforms	60
Adjusting Trigger Hold-Off.....	61
Setting Trigger System.....	62
Common Setting.....	64
Edge Trigger.....	65
Pulse Width Trigger.....	66
Video Trigger.....	67
Slope Trigger.....	68
Setting Acquisition Mode.....	71
Setting the Display.....	72
Setting Auto Measurements.....	74
Recording and Storage.....	80

Item	Page
Recording.....	80
Storage.....	83
Recalling.....	84
Making Cursor Measurements.....	86
Interface Setup.....	88
Utility Setup.....	89
Executing Mathematic Functions.....	91
Autoset.....	96
Chapter 7 Troubleshooting.....	97
The Oscilloscope cannot power on.....	97
The Oscilloscope turns off just a few seconds later after powered on.....	97
Measuring voltage amplitude is 10 times larger or smaller than exactvalue.....	97
No waveform displays after acquiring signals.....	97

Item	Page
The waveform does not display steadily.....	97
There is no display after pressing down RUN/STOP button.....	98
The display slows down after having applied AVG mode for a while.	98
The waveform display has a stair-stepping shape.....	98
Chapter 8 Service and Support.....	99
Updating Program.....	99
Preparations before Update.....	99
Update Conditions.....	99
Program Update.....	99
Chapter 9 Appendixes.....	102
Appendix A: Technical Specifications.....	102
Appendix B: Maintenance.....	111

Chapter 1 Safety Information

Safety Terms and Symbols

Terms in the manual

Following terms may appear in this manual:

Warning: a Warning specifies conditions and actions that may pose hazards to the user.

Caution: a Caution identifies conditions and actions that may cause damage to the product or other properties.

Terms on the product

Following terms may show on the product:

DANGER indicates any injury hazard immediately accessible as you read the marking.

WARNING indicates any injury hazard not immediately accessible as you read the marking.

CAUTION indicates any damage may happen to the product or other properties

Symbols on the product

Following symbols may show on the product:

Symbols on the product

The following symbols might be on the product:



High Voltage



Refer to the manual



Measuring Ground Terminal

General Safety Overview

The oscilloscope is strictly designed and manufactured as per safety/compliances: GB4793 safety requirements for electronic measuring instruments, IEC61010-1, Overvoltage CATIII 600V and Pollution Degree II.

Please review following safety precautions to avoid personal injury or any damage to this product or any products connected to it. Operate the product as specified to prevent any potential hazards. Only the qualified personnel can perform the servicing procedures.

Warning: To avoid electric shock or fire, use only the power adaptor specified for the Oscilloscope and certified for the power grid by the country of use.

Warning: If the Oscilloscope terminals are input with voltages higher than 42V (30 Vrms), to avoid personal electric shock:

- Use only the insulated voltage probe, test leads and power adaptor supplied or specified by UNI-T for this Oscilloscope Series.
- Please check multimeter test leads, oscilloscope probe and other accessories for any mechanical damage. Please make the replacement if any damage is found.
- Remove all unused test leads, probe and other accessories.
- Insert the power adaptor first into AC socket before connecting it to the Oscilloscope.
- Do not input voltages higher than 300V into scope terminals under CAT II measuring environment; working voltage applied into multimeter terminals must not exceed 600V under CATIII measuring environment.
- Do not apply working voltage higher than rated values on the Oscilloscope

- Use only the accessories supplied for the Oscilloscope, do not use them if any damages are found.
- Do not plug any metal object into the connectors
- Use the Oscilloscope as specified.
- Rated voltage value mentioned in “Warning” is the “working voltage” limit for the power adaptor. It represents V_{rms} (50-60Hz) when applying AC sinewave.

Only qualified staff can perform the servicing.

Check all terminals ratings: To avoid fire or electric hazard, please observe all ratings and symbols on the Oscilloscope. Read through the manual for details before making connections to the Oscilloscope

Do not operate with suspected failure: Please have it checked by qualified servicing staff if you doubt the product does not work normally.

**Do not operate in damp environment.
Do not operate in explosive environment
Keep the product surface clean and dry**

Chapter 2 UTD1000L Series Oscilloscope Overview

UTD1000L Series Oscilloscope

Introduction

UTD1000L Handheld Digital Storage Oscilloscope (Hereinafter referred to as “The Oscilloscope”) combines digital scope and multimeter functions just into one tool. The ease-of-use feature, excellent technical indicators and multi-functions offered the Oscilloscope can get your work done much faster.

The series offers four models for your option:

Type	Bandwidth	Sampling velocity	Channel count
UTD1025CL	25MHz	200MS/s	Single channel
UTD1050CL	50MHz	200MS/s	Single channel
UTD1025DL	25MHz	250MS/s	Dual Channel
UTD1050DL	50MHz	250MS/s	Dual Channel

UTD1000L Series Oscilloscopes offer users a simple and clear front panel that helps to perform primary operations, a design you often get used to and can save you a great amount of time to learn about the Oscilloscope. In order to speed up calibrations and measurements, pressing **AUTO** button can make the oscilloscope display proper waveforms and settings directly. Meanwhile the Oscilloscope offers **SHIFT** button to combine with other buttons to further operate the menus much easier. Beside ease of use, this series outstands itself with superb performance and powerful functions, such as remarkable trigger and analysis ability, making it easy to capture and analyze the waveforms; high-definition Display and math function, ensuring a very clear and fast view on waveforms and finding out the signal problem.

UTD1000L Series Oscilloscope Accessories

Unpack the carton and you will see following accessories should be included:

No.	Instruction	Standard configuration
1	UNI-T oscilloscope	●
2	Power Adaptor, 1 pc	●
3	UTD1000CL Standard Probe, 1pc; UTD1000DL Standard Probe, 2pcs	●
4	Multimeter Test Leads, 2pcs (one red, one black)	●
5	UTD1000CL standard UT-M07 (10A current divider module), 1pcs; UTD1000DL standard UT-M04 (4A current divider module), 1pc; UT-M10 (mA current module), 1pc.	●
6	Oscilloscope probe adjusting tool, 1pc	●
7	USB wire, 1pc	●
8	Operating Manual, 1pc	●
9	CD (for communication software between PC and the Oscilloscope), 1pc	●
10	carrying bag, 1pc	●

UTD1000L Series Oscilloscope Key Features

Scope

- **Totally Auto Scale**; Vertical Scale and Timebase automatically adjusted with the signal and without any manual interference;
- **Unique and powerful Auto Setup**, quick and accurate to set up for signals with any DC component;
- **Wider voltage measuring range**; Coupled with 10×probe with attenuation up to 200V/div;
- **Isolated USB** for much safer communication;
- **Color**, White& black display for your option, perfect for use outdoors with strong sunshine.
- **Intelligent local or network software** update
- **Unique waveform record, storage and recall** functions
- **High-resolution and high-contrast color LCD**

- 8 hours of continuous battery operation for UTD1000CL and 6 hours for UTD1000DL
- UTD1000CL: 19 types of auto measurements
- UTD1000DL: 22 types of auto measurements
- Simple Printscreen function
- Multilingual help information

Multimeter

- 3999 display count
- Voltage, current, resistance, diode, capacitance, continuity measurements offered
- Measure current up to 10A (UTD1000DL 4A max.)
- Extremely low internal resistance designed for current measurement, ensuring better measuring accuracy.
- Independent multimeter and scope functions in one tool

Chapter 3 Oscilloscope Connection

General Check

It is recommended that you should proceed following inspections when you get a new UT1000L series oscilloscope.

Checking for any damage due to the transit

Contact UNI-T dealership or local UNI-T office immediately if the packing carton or foamed plastic cushion is seriously damaged.

Checking the Accessories

The accessories supplied for the Oscilloscope are listed in the section “UTD1000L Series Oscilloscope Accessories” hereinbefore. Please refer to the section and check if any accessory is missing.

Please contact UNI-T dealership or local UNI-T office if there is any damage or missing item.

Checking the Whole Oscilloscope

If the Oscilloscope is found damaged externally or it does not work normally or pass any performance test, contact our UNI-T dealership or local UNI-T office

If the product is damaged due to the transit, keep the package and inform the shipping agency and UNI-T dealership, UNI-T will arrange the maintenance or replacement for you.

Oscilloscope Connections

Connection Interfaces

See Figure 3-1 for the Oscilloscope connection interfaces

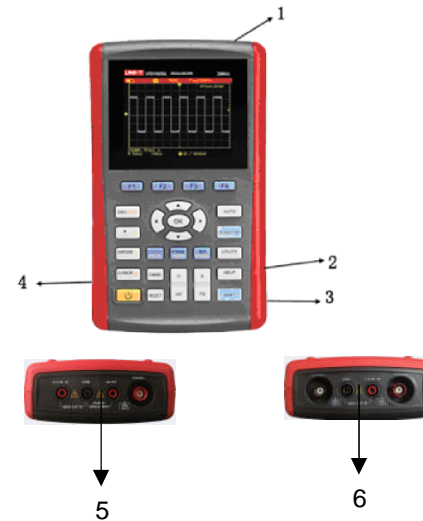

Figure 3-1 Oscilloscope Connection Interfaces

Description:

1. Input terminals for scope channels.
2. USB Connection port
3. The port to connect power adaptor for AC power supply and battery charge.
4. Output terminal for probe compensation
5. UTD1000CL multimeter input terminals.
6. UTD1000DL multimeter input terminals.

Compensation Output Connection

Connect to the output (1kHz/3V) terminal as shown below for the Oscilloscope probe compensation.









Picture 3-2 Compensation Signal Output Connection of the Apparatus

Front Panel and Keypad

Learn about the Oscilloscope front panel and buttons shown in Figure 3-3:



Figure 3-3 UTD1000L Series Front Panel

-  : To power on/off the Oscilloscope
- F1~F4**: To set up the submenus
-  : To toggle between Scope (DSO) and multimeter (DMM) modes.
-  : Press this button to access ACQUIRE (sample mode) menu if under DSO mode; press **[SHIFT]** first and then this button to access intensity, with help of right and left arrow buttons, you can change screen brightness. If under DMM mode, pressing this button can access voltage measurement menu.
-  : Press this button to access DISPLAY (Display mode) menu if under DSO mode; or press **[SHIFT]** first and then this button to access CONFIGURE (interface configuration) menu; pressing this button under DMM mode to access current measurement menu.
-  : Press this button under DSO mode to access MEASURE (auto measurement) menu; or press **[SHIFT]** first and then the button to access COURSOR (cursor measurement) menu; if under DMM mode, press the button to access resistance measurement menu and measure resistance/diode/continuity/capacitance.
-  : In DSO mode, press it to access CHANNEL menu for UTD1000CL; repeatedly press to toggle between two channel menus for UTD1000DL
-  : In DSO mode, press the button to access FFT menu for UTD1000CL; or press the button and then **[F1]** button to toggle between FFT and MATH menus for UTD1000DL. Press **[SHIFT]** first and then the button to access **[STATUS]** display.

STORAGE RECORD : In DSO mode, press to access RECORD (waveform record) menu; or press **SHIFT** first and then the button to access STORAGE menu.

REF SINGLE : Under DSO mode, press to set up SINGLE (single trigger) function; press first **SHIFT** and then the button to access REF (waveform recall) menu.

AUTO : Under DSO mode, press to automatically set up the waveform; press **SHIFT** first and then the button to switch on full autose function. The Oscilloscope can automatically adjust the ranges to obtain optimal waveform based on the input signal without any manual interference.

RUN/STOP : Under DSO mode, press to start/stop data acquisition; if under DMM, press the button to lock measuring readings on the screen.

UTILITY TRIGGER : Under DSO mode, press to access

TRIGGER menu; or press **SHIFT** first and then the button to access **UTILITY** menu;

HELP HORIZONTAL : Under DSO mode, press to access **HORIZONTAL** menu; or press **SHIFT** first and then the button to open **HELP** information.

SHIFT : Combine with other buttons to select function options

s : Timebase: To change scan rate, ranging from 50s/div~10ns/div for 25MHz-bandwidth models and 50s/div~5ns/div for 50MHz-bandwidth models and stepping in 1-2-5. Press “s” to access relatively slower scan rate or “ns” to speed up.

v : Vertical Scale: To change vertical scaling, ranging from 5mV/div~20V/div and stepping in 1-2-5. Press “V” to zoom in current vertical scale or “mV” to zoom out.



: To toggle between vertical position and trigger level, if vertical position is chosen, vertical reference cursor turns solid, then you can move waveforms vertically with Up and Down buttons. Press **SELECT** again to make trigger level cursor solid, and also use Up and Down buttons to adjust trigger point location Under **MEASURE** menu, this button is used to confirm selected parameters, or it is to toggle between Cursor 1 & 2 under cursor measurement.



: Arrow and **OK** buttons: **OK** button is used to hide/display current menu; under **DMM** mode, it is used to confirm if current divider has been properly connected when making A current measurement.

Shortcut Buttons Description:

SHIFT+OK: To save current interface into internal memory, which can be exported externally by PC which has been loaded with the Oscilloscope software.

SHIFT+AUTO: to open full autoset function, in which the Oscilloscope can automatically adjust vertical scale and horizontal timebase based on the input signal so that the optimal waveform can be obtained without any manual operation .

SHIFT+F1/F2/F3/F4: To open main trigger menu

Chapter 4 Using Basic Oscilloscope Functions

About the Chapter

This chapter only briefs users on basic functions of the Oscilloscope, for example, how to use menus and execute basic operations, not a step-by-step introduction on all functions.

Powering on the Oscilloscope

UTD1000L Series can be powered by: the battery and power adaptor. The power supply voltage from the adaptor is DC9V/1.5A. To operate the Oscilloscope normally, please use the power adaptor specified for the Oscilloscope. Press Power button and **[SHIFT]** light illuminates for 3 seconds, then the Oscilloscope logo appears, indicating the Oscilloscope has already turned on.

Describing the Display

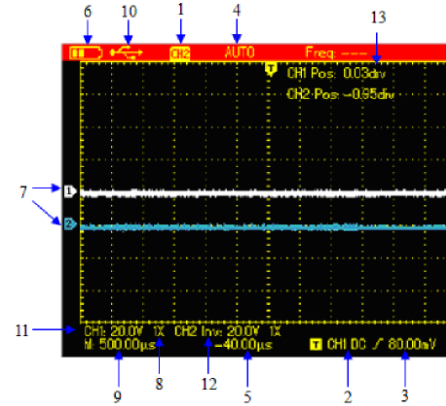

Figure 4-1 Display Interface

Besides the waveform, there are still a lot of details about the waveform and oscilloscope control settings on the screen:

1. Trigger source status:

CH1/CH2: indicates you can adjust the waveform of this channel

REF: indicates you can adjust the recalled waveform.

FFT: indicates you can execute FFT operation on the waveform

2. Trigger coupling:

AC ac-coupled

DC dc-coupled

HF high-frequency reject

3. Trigger level readout

4. Trigger status:

ARMED The Oscilloscope is acquiring all pre-trigger data and ignores all trigger events;

READY The Oscilloscope has acquired all pretrigger data and is ready to trigger;

TRIG' ED The Oscilloscope has detected out one trigger and is acquiring posttrigger data;

STOP The Oscilloscope has stopped acquiring waveforms

AUTO The Oscilloscope is in auto mode and acquires waveforms without trigger;

SCAN The Oscilloscope continuously

acquires and displays waveforms under scan mode.

5. The time readout that indicates how far the trigger point is from the central point;

6. The power supply indicator:

 The Oscilloscope is powered by the battery;

 The Oscilloscope is powered by DC power adaptor.

7. The marker for ground reference point for displayed waveforms;

8. 1× indicates probe attenuation factor for the channel is 1×;

9. The readout for main timebase setting;

10. “Connected to PC” icon;

11. Readout for the current vertical scale factor;

12. Waveform Invert Indicator that indicates that the waveform is reversely displayed; horizontal midline.

13. Position readout from the channel reference marker to the horizontal line on the screen.

Resetting the Oscilloscope

To reset the Oscilloscope to the default, do the following:

1. Press **[SHIFT]** button, “shift” icon displays on the upper right corner of the screen;
2. Press **[UTILITY]** button and four options shows on the bottom display;
3. Press **[F2]** button to select the default setup. Then the Oscilloscope is set to the default settings;

Note: Pressing up arrow button can also set the Oscilloscope to the default when powering on.

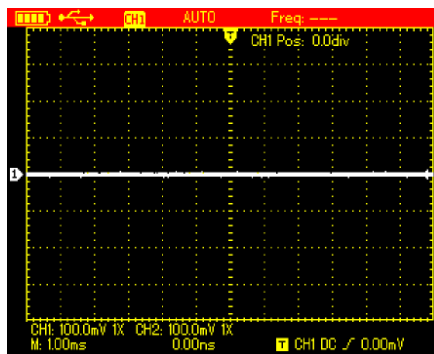

Figure 4-2 Default Setup

The Default setup is as follows:

Functions	Default Setup
Acquire Mode	Norma
SEC/DIV	1ms/div
VOLT/DIV	100mV/div
Trigger Coupling	DC
Channel Status	CH2 Off (1000DL series)
Trigger Mode	Auto
Display Format	Vector
Persist Time	Auto
Display Style	Classic
Manual Display	Manual

Using Functional Menus

The procedures below show you how to select functions with use of oscilloscope menus;

1. Press any functional button on the keypad, then corresponding options will show on the bottom display, you can select one of these options with use of **[F1] ~ [F4]**. After that, press **[OK]** button to hide functional menus;

2. For the buttons printed with multiple functions, if you want to choose one of these functions, please press **SHIFT** button first, accompanied by shift icon on upper right corner of display, then press the corresponding button to obtain the function you want.

Hiding Menus

Press down **OK** button to hide all button icons and menus. To display menus or button icons, press OK again.

Note: To set up auto hiding time for menus, please find corresponding option in **CONFIGURE** menu.

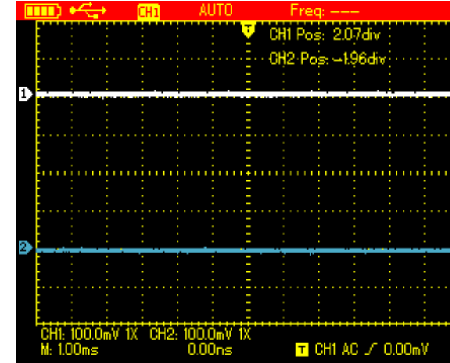

Figure 4-3 Hiding Menus

Making Connections for Probe Compensation

Connect the signal as follows:

1. Connect the probe connector to the Oscilloscope input terminal and switch probe factor to 10× on the probe.
2. You also need to set up probe factor on the Oscilloscope, this factor changes vertical scale

and ensures the accuracy for measurements. To set up the probe factor on the Oscilloscope, press **CHANNEL** button, then **F3** to set probe factor to 10X.

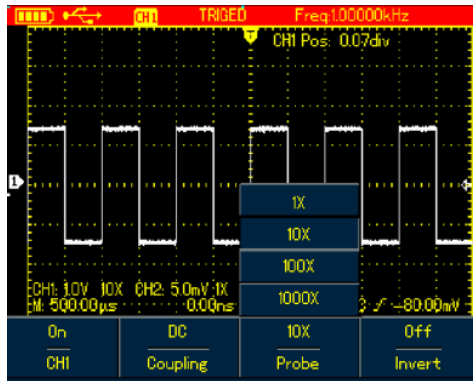

Figure 4-4 Adjusting Probe Factor

3. Connect the probe to the output terminal for probe compensation on the Oscilloscope, press **AUTO** button, after several seconds, square wave displays (1kHz, 3Vpp, Peak-to-Peak Value), See Figure 4-5.

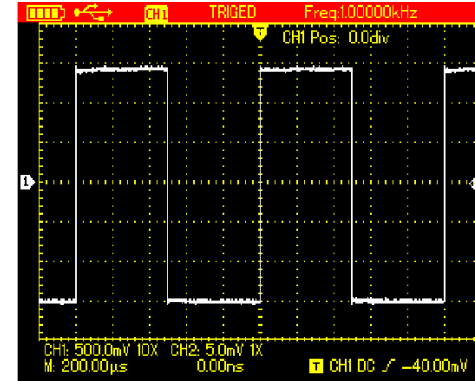

Figure 4-5 Squarewave Signal from the Oscilloscope Itself
Compensating the Probe

You need to compensate the probe whenever connecting it to channels for the first time so as to match the probe to the input channel. Uncompensated probe may cause deviation or error to the measurement. To compensate the probe, do the following:

1. First of all, set probe factor on the Oscilloscope to 10X, turn the switch to 10X on the probe,

then connect the probe connector to the oscilloscope input channel and the probe tip to compensation output terminal;

2. Then execute AUTO

3. Observe the displayed waveform

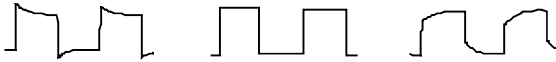

Over compensation correct compensation under compensation

If the displayed waveform is under-or over-compensated as indicated above, use the adjusting tool with non-metal handle to adjust the variable capacitor on the probe until correctly compensated waveform shows.

Warning: To avoid any electric shock when measuring the high voltage with use of the probe, please ensure the probe wire is perfectly insulated, and do not touch any metal part of the probe while connecting to the high voltage source.

Setting Vertical&Horizontal Systems and Trigger Level Manually

Vertical System

Press $\boxed{V} \sim \boxed{mV}$ buttons to adjust the vertical scale(VOLT/DIV) and display waveform with proper size on the screen;

When channel cursor turns solid, press Up and Down button to adjust ground reference point that can allow the waveform to display at proper location;

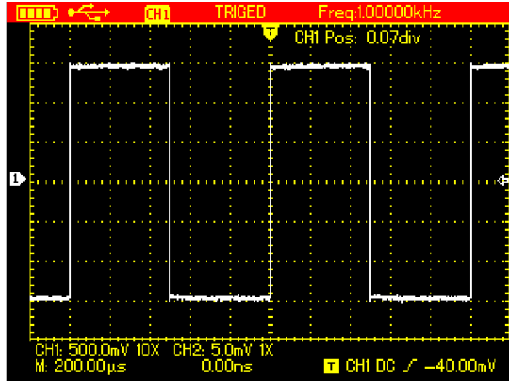

Figure 4-6 Moving Waveforms Vertically
 Note: Use **SELECT** button to toggle between vertical position and trigger level.

Horizontal System

Press down s~ns buttons to change the timebase, and the timebase readout in status bar will vary accordingly. The horizontal scan rate ranges from 5ns~50s/div (10 ns~50s/div for 25MHz-bandwidth models) and steps in 1-2-5

Press Right and Left arrow buttons to adjust the horizontal location of the trigger point, which can allow to observe more pretrigger data;

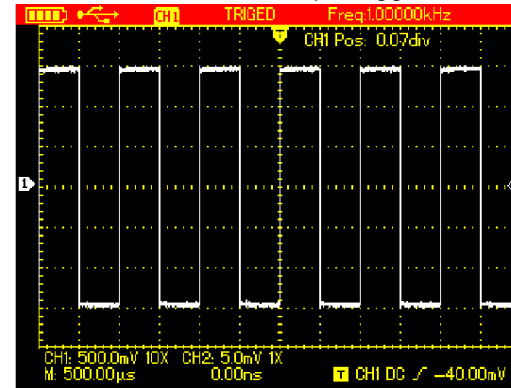

Figure 4-7 Adjusting Horizontal Timebase

Trigger Level

When trigger level cursor turns solid, use Up and Down arrow buttons to adjust trigger level location.

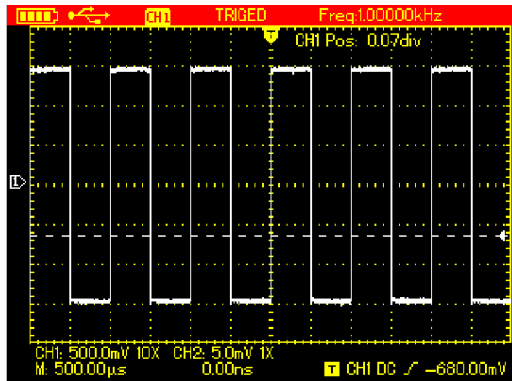

Figure 4-8 Adjust Trigger Level

Note: Use **SELECT** button to toggle between vertical position and trigger level for the channel. Following chapter will offer more details about the operation mentioned above

Autoset for Waveform Display

UTD1000L Series is designed with autoset function that can automatically adjust the vertical scale, scan timebase and trigger mode based on the input signal until the optimal waveform can be obtained. To apply the autoset function, the tested signal should have a frequency at $\geq 20\text{Hz}$ and duty cycle $> 1\%$;

Under **AUTOSET** mode, the coupling mode of the channel is closely connected to DC autoset ; When DC autoset is set to off, all signals in the channel is AC-coupled. If DC autoset is on, the channel will choose the current setting as coupling mode, when the current setting is DC coupling, the signal will be DC-coupled and vice versa.

For example:

1. Input 1kHz, 2Vpp sine signal into two channels, set coupling mode for both channels to DC, press **Shift+UTILITY** and then **F3** to set

set DC autoselect to off. If **AUTOSET** is applied, the coupling mode is switched to AC mode.

2. Input 1kHz, 2Vpp sine signal into two channels, then set AC coupling for one channel and DC mode to the other. When **AUTOSET** is applied, the coupling modes for both channels keep unchanged.

Full Autoset for Input Signal

UTD1000L can offer creative auto function to capture input signal. With this function applied, the Oscilloscope varies ranges accordingly based on the input signal until the proper waveform display can be obtained without any manual interference.

To perform autoset function, do the following:

1. Press **SHIFT** button, the shift icon shows on upper right corner of the screen
2. Press **AUTO** button, when A icon displays on the screen, autoset function has already turned on;

Note: When the model is UTD1000DL and both of its two channels have signals, the signal from the trigger source channel will be automatically displayed and the other channel will turn off under autoset mode; if there is only one channel input with signals, this channel signal will be automatically selected and displayed no matter which channel has been chosen as the trigger source.

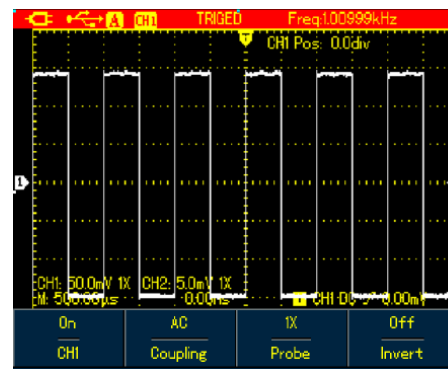

Figure 4-9 Full Autoset

Note:

1. Under autoset mode, trigger mode is set to “Auto” and cannot change.
2. Once you are in autoset mode, following settings are forced to execute:
 - (1) The Oscilloscope will switch into main timebase status if the current display isn't under this status;
 - (2) The coupling mode will be set to AC mode and allows no change.
3. Any adjustment on the vertical scale or horizontal timebase of the Oscilloscope that has changed waveform vertical or horizontal location will make the Oscilloscope automatically exit autoset mode.

Run/Stop Data Acquisition

To stop the data acquisition:

1. Press **RUN/STOP** button, the Oscilloscope stops data acquisition and **STOP** indicates on the upper display;
2. Repress **RUN/STOP**, then the oscilloscope will restart the acquisition.

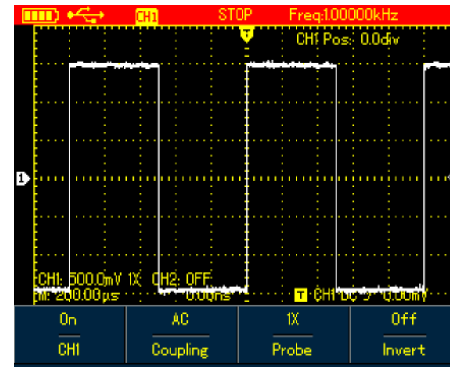

Figure 4-10 Stop Data Acquisition

Setting Frequency Counter

To switch on the frequency counter in models such as UTD1000CL, do the following:

1. Press **[SHIFT]** button, and shift icon shows on upper right corner of screen;
2. Press **[UTILITY]** button to display utility menu;
3. Press **[F3]** button to set the frequency counter to “On”

Note: The frequency counter of UTD1000DL defaults at On status.

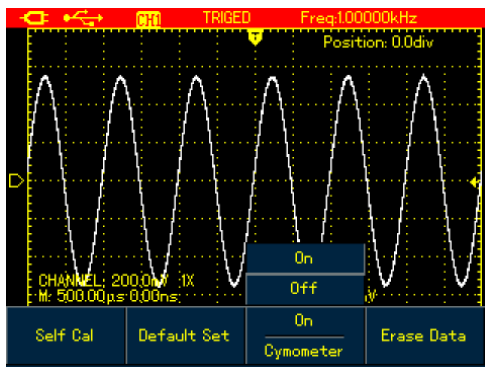

Figure 4-11 1000CL Trigger Frequency Counter

Adjusting Screen Intensity

To adjust the intensity of the screen, do the following:

1. Press **[SHIFT]** button, and shift icon shows on upper right corner of screen;
2. Press **[ACQUIRE]** button and select backlight menu;
3. Press **[F1]** to switch on backlight intensity bar;
4. Press **[Left and Right]** arrow buttons to adjust the intensity to proper value;
5. Press **[F1]** to switch off the backlight intensity bar.

Note: Press down **[AUTO]** button, the backlight intensity bar will switch off automatically.

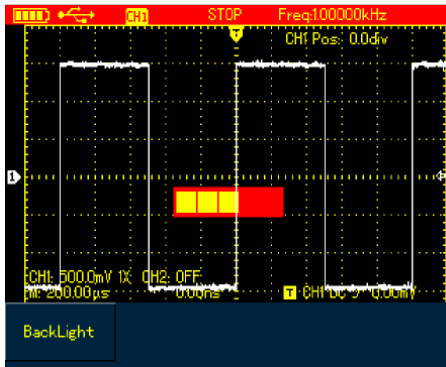

Figure 4-12 Adjusting Backlight Intensity

Saving Bitmap

To save bitmap, do the following:

1. Press **[SHIFT]**, and shift icon shows on upper right corner of screen;
2. Press **[OK]** button, bitmap then will immediately be saved to the internal memory.

Note: through control software loaded in PC, the

bitmaps can be exported to PC in BMP format and be saved up to 10sets.

Using Online Help

To use built-in help information, do the following:

1. Press **[SHIFT]**, and shift icon shows on the right corner of screen;
2. Press **[HELP]** button, H icon shows on the upper display, indicating Help function has already turned on;
3. Then you can press corresponding menu buttons to check detail information;
4. To turn off this function, repeat Step1 and 2.

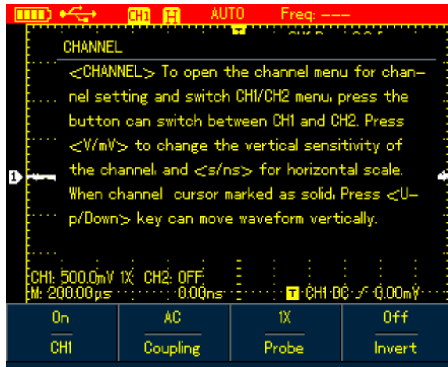

Figure 4-13 Help System

Setting Single Trigger

To set trigger mode to Single directly, do the following:

1. Press **SINGLE** button, the Oscilloscope will be set under single trigger mode immediately.

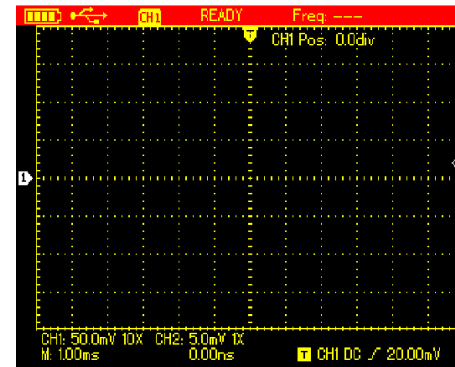

Figure 4-14 Single Trigger

Viewing Oscilloscope Status

To view the current status of the Oscilloscope, do the following:

1. Press **[SHIFT]** button, and shift icon shows on upper right corner of screen;
2. Press **[STATUS]** button, current settings of the Oscilloscope will be displayed on the screen;
3. To turn off the information, repeat Step 1 and 2.

Note: Press down **[AUTO]** button, status information will then automatically turn off.

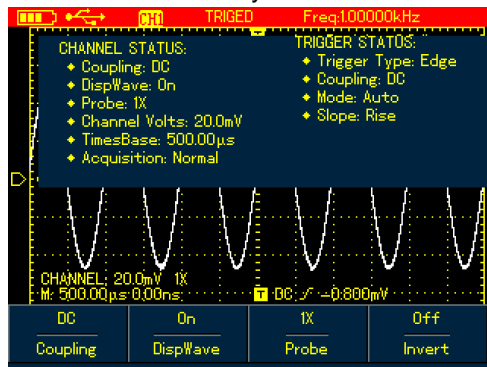

Figure 4-15A UTD1000CL Status Information



Figure 4-15B UTD1000DL Status Information

Checking Oscilloscope System Information

To check the system configuration of the Oscilloscope, do the following:

1. Press **SHIFT** and shift icon shows on upper right corner of screen;
2. Press **CONFIGURE** button to switch on display configuration menu;
3. Press **F4** button, then details such as oscilloscope model, version will show on the screen;
4. Press **F1** button to switch off the displayed window.

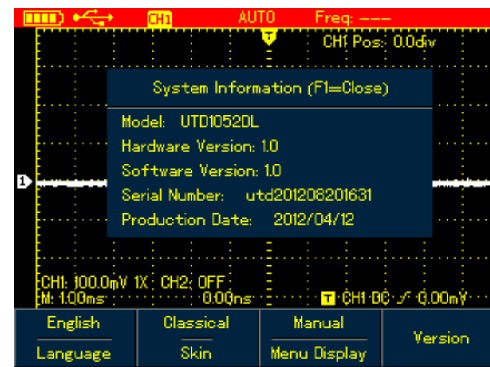

Figure 4-16 System Information

Making Auto Measurements

There are two kinds of auto measurements available in the Oscilloscope: Measure all or customized parameters. Maximum 4 parameters can be selected if you want to customize your own measurements.

Measuring All Parameters

To measure automatically all parameters, do the following:

1. Press **MEASURE** button to display measurement menu;
2. For UTD1000CL, press **F1** button (press **F2** for UTD1000DL), then the screen will show measurement results for all parameters.

Note:

- 1) Switching between different signal sources in UTD1000DL will change the parameters accordingly for channels;
- 2) If the signal is input into only one channel of UTD1000DL, the rise delay, fall delay and phase parameters will not be measured when this channel is chosen as the signal source; or the signal source is set to the channel without signal input, no parameter measurement will be made.



Figure 4-17A UTD1000CL measures all parameters

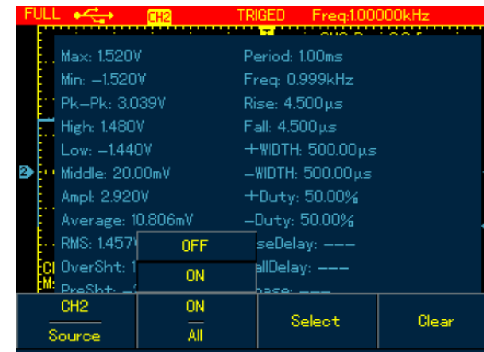

Figure 4-17B UTD1000DL measures all parameters

Measuring Customized Parameters

To measure customized parameters, do the following:

1. Press **MEASURE** button to display measurement menu;
2. For UTD1000CL, press **F2** button (**F3** for UTD1000DL), the screen will display measurement parameters available for your selection;
3. Press Arrow Buttons to select the desired parameters, indicated in different color;
4. Press **SELECT** button to confirm, the selected parameter will automatically show on the screen. You can select up to 4 parameters.
5. To turn off the menu, press **F2** in UTD1000CL (for **F3** in UTD1000DL).

Note: For UTD1000DL, use **F1** to select signal source to be measured.

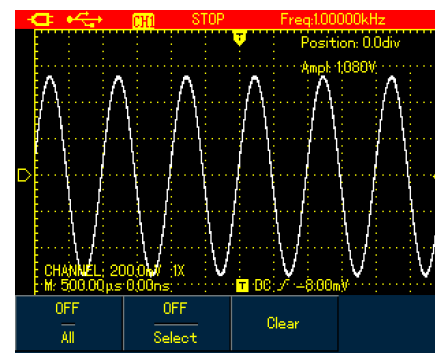

Figure 4-18A UTD1000CL Customized Measurement

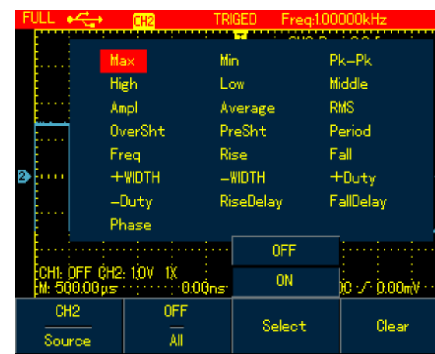

Figure 4-18B UTD1000DL Customized Measurement

Using AVG mode for Smoothing Waveforms

To smooth the waveforms, do the following:

1. Press **ACQUIR** button to display sample mode;
2. Press **F1** button to set sample mode to AVG;
3. Press **Left** and **Right** arrow buttons to set AVG number to **16**. Then measurement results will show after the Oscilloscope has averaged the data for 16 times.

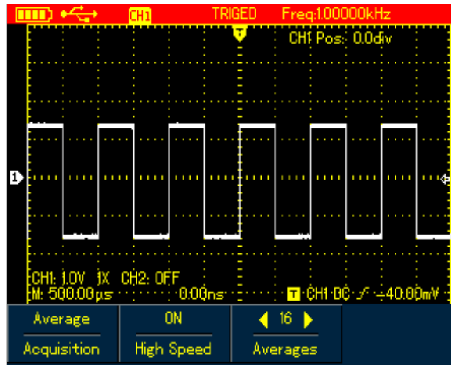

Figure 4-19 Smoothing with 16-times AVG Mode

Using Peak Detect Mode for Pulse Peak Display

This function can be used to display waveforms at 50 ns or wider (Pulse Peak or other asynchronous waveform).

1. Press **ACQUIR** button to display sample mode menu;
2. Press **F1** button to set sample mode to **Peak Detect**.

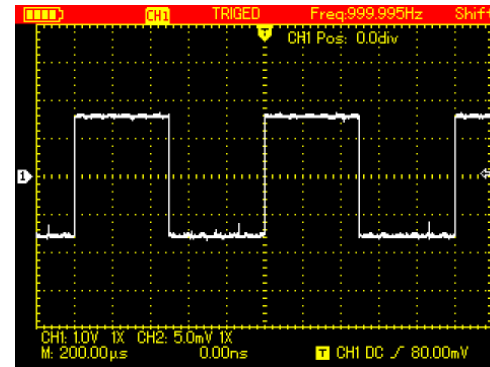
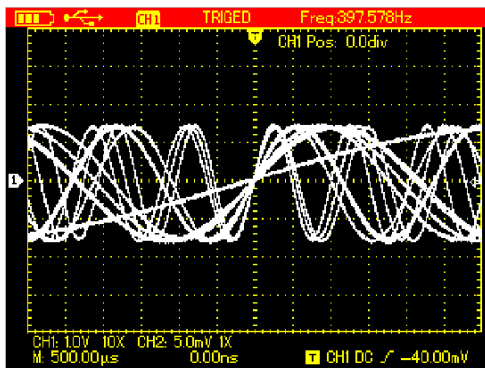

Figure 4-20 Sampling with Peak Detect Mode

Observing Waveforms with use of Persistence

Select the Persistence function if you want to observe continuously the dynamic signals.

1. Press **[DISPLAY]** button to show **Display Mode** menu;
2. Keep pressing **[F4]** button to select between 1sec, 3sec, 5sec, Infinite or Auto options. If display mode is set to **Infinite**, dynamic signals will be kept on the screen. When set to Auto, the **Persistence** function will turn on accordingly.



30 Figure 4-21 Persistent Display for 3 Seconds

Selecting AC Coupling

The screen displays both AC and DC voltages if the oscilloscope is set under DC coupling. If only the small AC signal mixed in the DC signal is expected to display, please select AC coupling mode.

To select AC coupling, do the following:

1. Press **[CHANNEL]** button to display **Channel** menu;
2. Press **[F1]** button (**[F2]** for UTD1000DL) to set Coupling to **AC**.

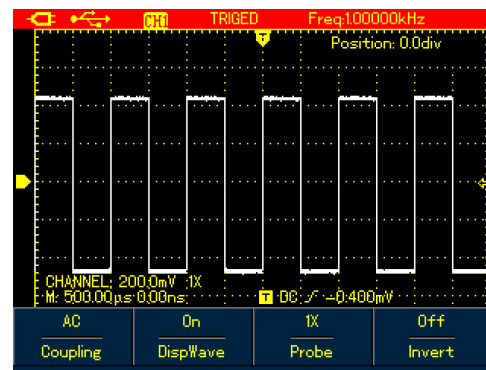

Figure 4-22A UTD1000CL AC Coupling

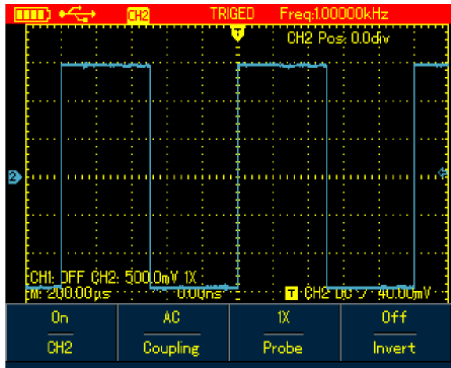

Figure 4-22B UTD1000DL AC Coupling
Inverting the Waveform Display

To invert the waveform on the display, do the following:

1. Press **CHANNEL** button to display Channel menu;
2. Press **F4** button to set **Invert** to **on**, then the waveform on the screen will be displayed reversely.

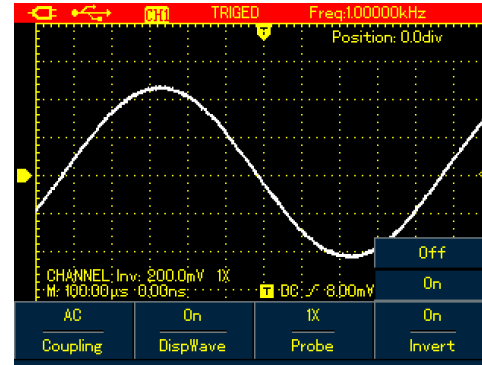

Figure 4-23A UTD1000CL Inverted Waveform

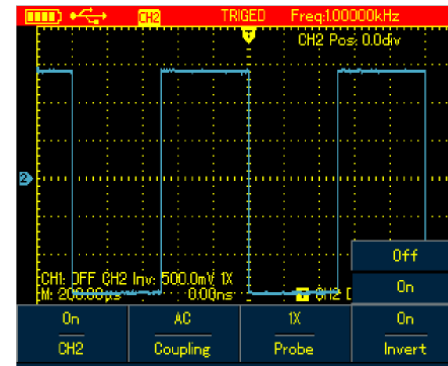

Figure 4-23B UTD1000DL Inverted Waveform

Autoset for Signals with DC Offset

UTD1000L Series is designed with powerful autoset function that makes it possible to perform fast and accurate measurement in DC-coupled mode for signals with any DC component. **Position** parameter on upper right display of screen: This parameter stands for position readout for the channel reference marker that moves from horizontal central line, if it is positive value, it indicates the channel marker is above the horizontal central line and the negative one is for the marker below the horizontal central line. To work out the final DC offset, first move the waveform to the center of the screen, then multiply the **Position** value by current amplitude range readout, that is final DC offset result you want. For example:

Connect UTD1000CL channel with 70mVpp AC sine signal mixed with 1.1V DC offset, set the channel to DC coupling, then perform **AUTO** function, the waveform in Figure 4-24A will

show on the screen. On the display, **Position** readout -53.63div indicates the channel reference marker moves 53.63div downward from the horizontal central line. The current amplitude range is 20mV/div, so DC offset readout: $20\text{mV/div} \times 53.63\text{div} = 1.0726\text{V}$

Vpp readout: 72mV means the AC peak-to-peak value of the signal

You can also directly read out the DC level through AVG value.

AVG value: 1.0726V, which stands for the signal DC level.

Through all parameters mentioned above, the signal can be understood very easily.

Note: For UTD1000DL models, **CH1** and **CH2** are both set to DC coupling when inputting the signal above, then perform the **AUTO** function, after that, also move the waveform to the center of the display(See Figure4-24B), and then calculate DC offset with use of Position readout and current amplitude range value.

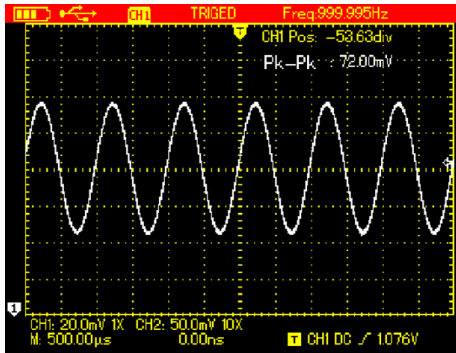

Figure 4-24A UTD1000CL Setup for Signals with DC Offset

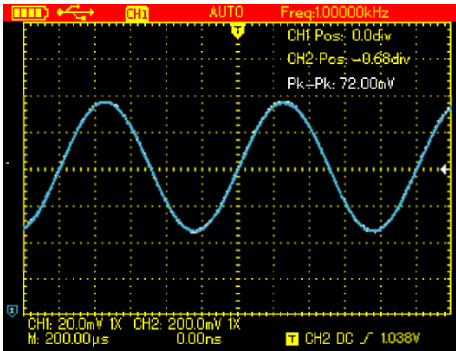

Figure 4-24B UTD1000DL Setup for Signals with DC Offset

As for traditional oscilloscope, it needs hard work to complete the task, for it has to set the coupling to AC mode first to measure out the AC parameters, and then reset the coupling to DC mode, manually adjust vertical scale and use the cursor to work out DC parameters, see figures as below:

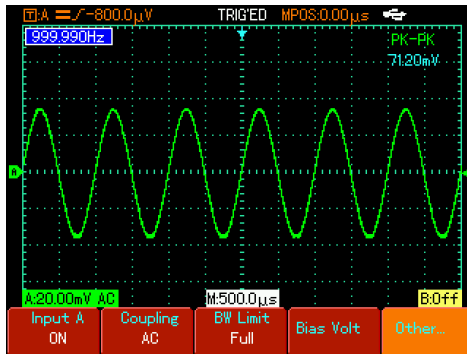

Figure 4-254 AC Parameter Measurement

With the comparison shown above, it is very clear that UTD1000L series is designed with a powerful ability to measure signals at much faster speed and in a more visual way.

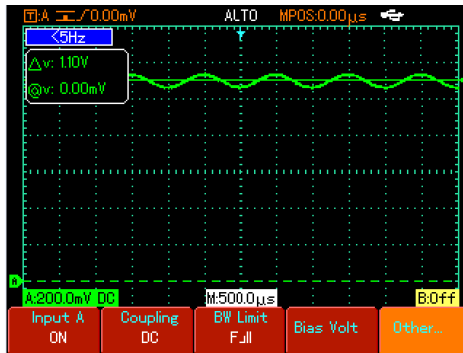

Figure 4-26 DC Parameter Measurement

Chapter 5 Using the Multimeter

About the Chapter

This chapter introduces the multimeter functions built in the Oscilloscope; examples are also offered to illustrate how to use the menus and the basic measurements. To switch from Oscilloscope mode to Multimeter mode, press DMM/DSO button to access DMM mode, the display screen will change into multimeter interface accordingly.

Connections to the Multimeter

UTD1000CL provides three multimeter input terminals: COM, V/Ω, μA/mA matched to 4-mm banana plugs of test leads. One 10A current divider UT-M07 is also used in the measurements.

UTD1000DL has two multimeter input terminals: COM, V/Ω, matched to 4-mm banana plugs of test leads. One UT-M04 (4A current divider) and one UT-M10 (mA current module) are also

offered to use in the measurements

Display Indicators

Description:

1.  Battery Indicator
2. AUTO Autoset indicator
3. Indicators for Measurement Types:
 - DC Voltage Measurement
 - AC Voltage Measurement
 - DC Current Measurement
 - AC Current Measurement
 - Resistance Measurement
 - Diode Test
 - Continuity Test
 - Capacitance Measurement
4. Relative Measurement
5. working statusIndicator; HOLD: Freeze the display
6. Main Display for Measuring Values
7. Manual Ranging Indicator

Making Multimeter Measurements

Press **DSO/DMM** button to access DMM mode, the display then enters into the multimeter interface. Multimeter functions are ready to use at the moment.

Measuring Resistance

To measure resistance, do the following:

1. Press down **R** button to set measurement type to **Resistance**.
2. Plug test lead connectors into multimeter input terminals (Black to COM and Red to V/Ω).
3. Connect test leads respectively to the resistor under test, then take resistance readings.



Figure 5-1 Measuring Resistance

Testing Diodes

To test the diode, do the following:

1. Press **[R]** button to set the measurement type to **Resistance**.
2. Press **[F1]** button to select **Diode** option.
3. Plug test lead connectors into multimeter input terminals (Black to COM and Red to V/ Ω).
4. Connect test leads to the tested diode, then forward voltage drop reading for the diode displays, accompanied by the measurement unit V.

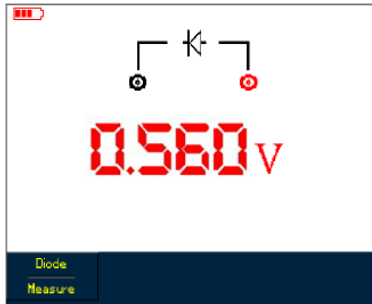

Figure 5-2 Testing Diode

Testing for Continuity

To check the continuity, do the following:

1. Press **[R]** to set the measurement type to **Resistance**.
2. Press **[F1]** button to select **Continuity**.
3. Plug test lead connectors into multimeter input terminals (Black to COM and Red to V/ Ω).
4. Connect test leads to tested points. The multimeter will beep if tested resistance between tested points is lower than 70 Ω .

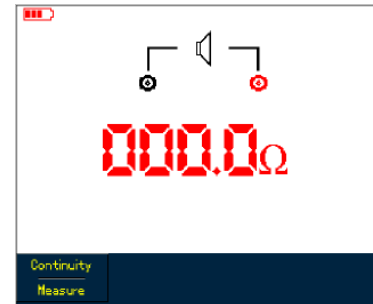

Figure 5-3 Testing for Continuity

Measuring Capacitance

To measure capacitance, do the following:

1. Press **[R]** to set the measurement type to **Resistance**.
2. Press **[F1]** button to switch measurement type to **Capacitance**.
3. Plug test lead connectors into multimeter input terminals (Black to COM and Red to V/Ω).
4. Connect test leads to the capacitor under test, then take the reading.

Note: To ensure the accuracy, please use the relative mode if test capacitance is < 5 nF.



Figure 5-4 Measuring Capacitance

Measuring DC Voltage

To measure DC voltage, do the following:

1. Press down **[V]** button to set measurement type to **DC Voltage**.
2. Plug test lead connectors into multimeter input terminals (Black to COM and Red to V/Ω).
3. Connect test leads respectively to tested points, then take DC voltage reading.

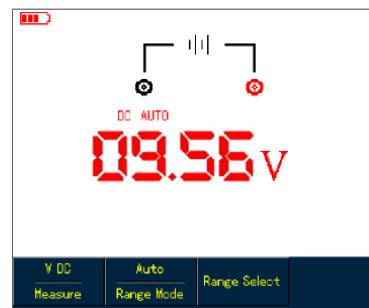

Figure 5-5 Measuring DC Voltage

Measuring AC Voltage

To measure AC voltage, do the following:

1. Press **V** button to set measurement type to **DC Voltage**.
2. Press **F1** button to select **AC Voltage** option.
3. Plug test lead connectors into multimeter input terminals (Black to COM and Red to V/Ω).
4. Connect test leads respectively to tested points, then take AC voltage reading.

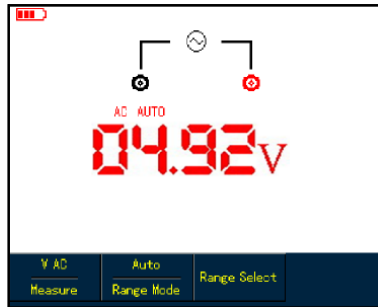

Figure 5-6 Measuring AC Voltage

Measuring DC Current with UTD1000CL

To measure DC current lower than 4mA, do the following:

1. Press **I** button to set measurement type to **DC Current**, measurement unit is μA , you can use **F3** to toggle between μA , mA and A ranges, the default is mA
2. Plug test lead connectors into input terminals (Black to COM and Red to μA / mA)
3. Connect test leads to tested points, then take DC current reading.

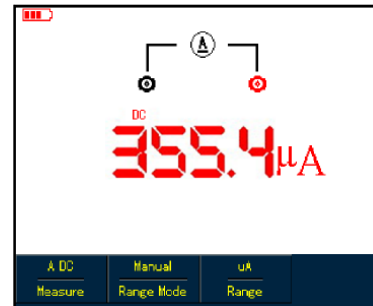

Figure 5-7 Measuring DC Current lower than 4mA

To measure DC current lower than 400mA, do the following:

1. Press **[I]** button to set measurement type to **DC Current**.
2. Press **[F3]** button to select **mA** range, and measurement unit will be **mA**.
3. Plug test lead connectors into input terminals (Black to COM and Red to $\mu A / mA$)
4. Connect test leads to tested points, then take DC current reading.

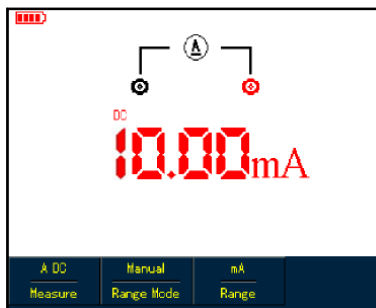

Figure 5-8 Measuring DC Current lower than 400mA

To measure DC current greater than 400mA, do the following:

1. Press **[I]** button to set measurement type to **DC Current**.
2. Press **[F3]** button to select **A** range, the measurement unit will change into **A** accordingly.
3. Plug 10A Current divider module (UT-M07) into input terminals COM and $\mu A / mA$, then connect black and red test lead connectors respectively to the module (UT-M07)
4. Connect test leads to tested points, then take the DC current reading.

Warning: If test leads are connected to COM and $\mu A / mA$ without use of 10A Current divider module (UT-M07) when measuring current greater than 400mA, the fuse in the product will be burnt out. Please have the fuse replaced by qualified personnel if the incident happens

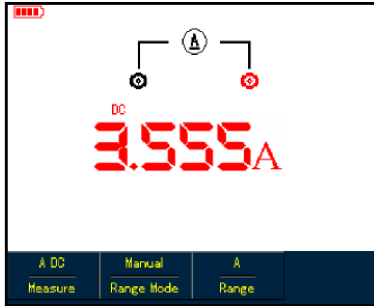

Figure 5-9 Measuring DC Current Greater Than 400mA

Measuring AC Current with UTD1000CL

To measuring AC current lower than 4mA:

1. Press **I** button to set measurement type to **AC Current**, the measurement unit is **μA**. You can use **F3** button to select between **μA**, **mA** and **A** ranges, the default is **μA**.
2. Plug test lead connectors into input terminals (Black to COM and Red to **μA /mA**)
3. Connect test leads to tested points, then take the AC current reading.

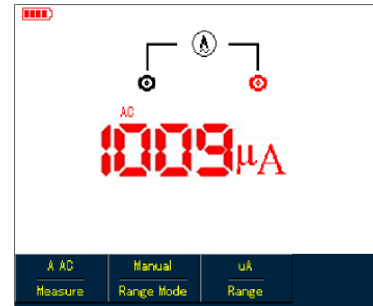

Figure 5-10 Measuring AC Current Lower Than 4mA

To measure AC current lower than 400mA, do the following:

1. Press **I** button to set measurement type to **AC Current**,
2. Press **F3** button to select **mA** range, and the measurement unit will show **mA** accordingly
3. Plug test lead connectors into input terminals (Black to COM and Red to **μA /mA**).
4. Connect test leads to tested points, then take the AC current reading.

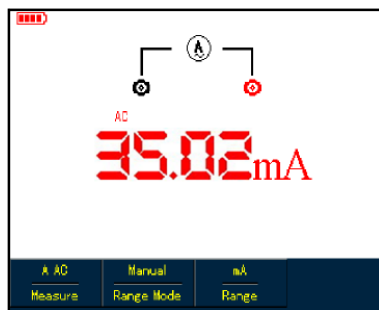

Figure 5-11 Measuring AC Current Lower than 400mA

To measure AC current greater than 400mA, do the following:

1. Press **I** button to set measurement type to **AC Current**,
2. Press **F3** button to select **A** range, and the measurement unit will change into **A** accordingly.
3. Plug 10A Current divider module (UT-M07) into Input terminals COM and $\mu A / mA$, then

insert black and red test leads properly into the module

4. Connect test leads to tested points, then take the AC current reading.

Warning: If test leads are connected to COM and $\mu A / mA$ without use of 10A Current divider module (UT-M07) when measuring current greater than 400mA, the fuse in the product will be burnt out. Please have the fuse replaced by qualified personnel if the incident happens

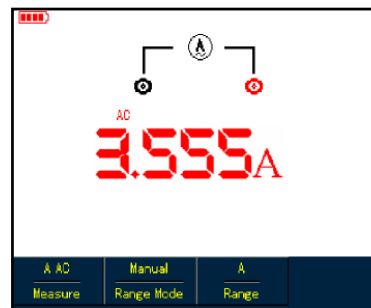

Figure 5-12 Measuring AC Current Greater than 400mA

Measuring DC Current with UTD1000DL

To measure DC current equal to or lower than 1mA, do the following:

1. Press **I** button to set measurement type to **DC Current**, the measurement unit is **μA**, you can use **F3** to toggle between **μA**, **mA** and **A** ranges, the default is **mA**
2. Plug mA current module (UT-M10) into input terminals COM and V/Ω, then turn the switch on the module to uA range.
3. Insert black and red test leads correspondingly into Black and Red terminals on the module
4. Then connect test leads to tested points, than take the DC current reading.

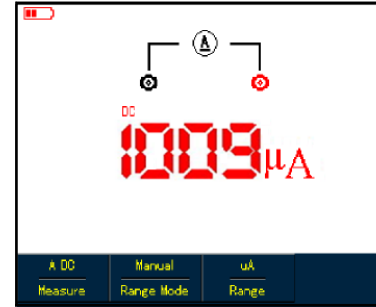

Figure 5-13 Measuring DC Current Equal to or Lower than 1mA

To measure DC current within 1mA–40mA, do the following:

1. Press **I** button to set measurement type to **DC Current**.
2. Press **F3** to select **mA** range, the measurement unit will change into **mA** accordingly.
3. Plug mA current module (UT-M10) into input terminals COM and V/ Ω , then turn the switch on the module to 40mA range.
4. Insert black and red test leads correspondingly into Black and Red terminals on the module.
5. Then connect test leads to tested points, then take the DC current reading.

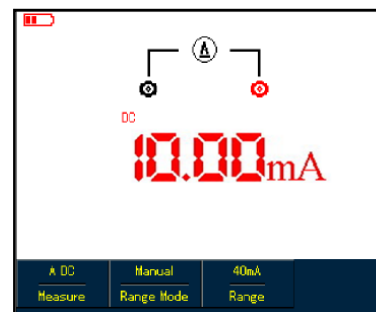

Figure 5-14 Measuring DC Current Lower than 40mA

To measure DC current within 40mA-400mA, do the following:

1. Press **I** button to set measurement type to **DC Current**.
2. Press **F3** to select **mA** range, and the measurement unit will display **mA** accordingly.
3. Plug mA current module (UT-M10) into input terminals COM and V/ Ω , then turn the switch on the module to 400mA range.
4. Insert Black and Red test leads correspondingly into Black and Red terminals on the module.
5. Then connect test leads to tested points, than take the DC current reading.

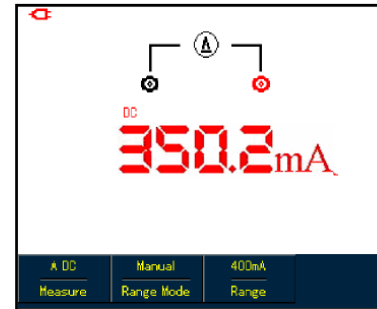

Figure 5-15 Measuring DC Current within 40mA-400mA

To measure DC current greater than 400mA, do the following:

1. Press **I** button to set measurement type to **DC Current**.
2. Press **F3** to select **A** range, and the measurement unit will display **A** accordingly.
3. Plug **4A** current module (UT-M04) into input terminals COM and V/ Ω , then insert test leads properly into the module.
4. Connect test leads to tested points, then take DC current reading.

Warning: If test leads are directly connected to V/ Ω and COM terminals without use of **4A** current module (UT-M04) when measuring the current greater than 400mA, the fuse in the product will be burnt out. Please have the fuse replaced by qualified personnel if the incident happens.

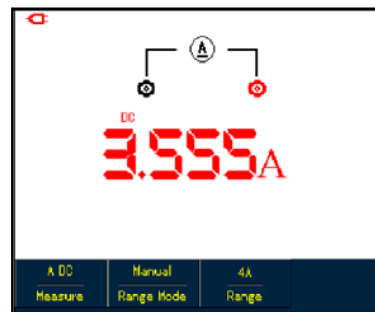

Figure5-16 Measuring DC Current Greater than 400mA

Measuring AC Current with UTD1000DL

To measure AC current equal to or lower than 1mA, do the following:

1. Press **I** button to set measurement type to **AC Current**, the measurement unit is **μA**. You can use **F3** button to select between **μA**, **mA** and **A** ranges, the default is **μA**.
2. Plug mA current module (UT-M10) properly into input terminals COM and V/Ω, then turn the switch on the module to uA range.
3. Insert Black and Red test leads correspondingly into Black and Red terminals on the module.
4. Connect test leads to tested points, then take the AC current reading.

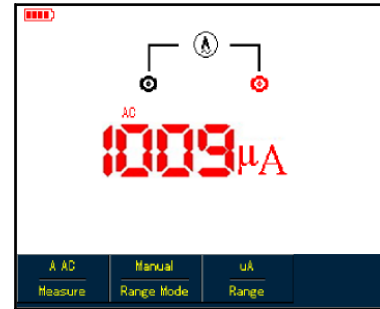

Figure 5-17 Measuring AC Current Equal to or Lower than 1mA

To measure AC Current within 1mA-40mA, do the following:

1. Press **I** button to set measurement type to **AC Current**,
2. Press **F3** to select **mA** range, the measurement unit will change into **mA** accordingly.
2. Plug **mA** current module (UT-M10) properly into input terminals COM and V/ Ω , then turn the switch on the module to 40mA range. Insert Black and Red test leads correspondingly into Black and Red terminals on the module.
4. Connect test leads to tested points, then take the AC current reading.

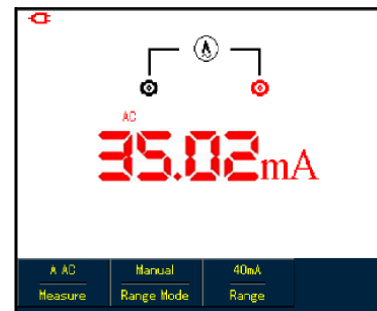

Figure 5-18 Measuring AC Current Lower than 40mA

To measure AC Current within 40mA-400mA, do the following:

1. Press **I** button to set measurement type to **AC Current**,
2. Press **F3** to select **mA** range, the measurement unit will change into **mA** accordingly.
3. Plug mA current module (UT-M10) properly into input terminals COM and V/ Ω , then turn the switch on the module to 400mA range.
4. Insert Black and Red test leads correspondingly into Black and Red terminals on the module.
5. Connect test leads to tested points, then take the AC current reading.

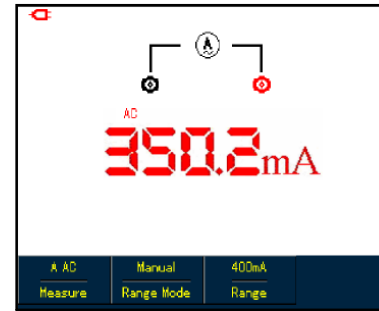

Figure 5-19 Measuring AC Current within 40mA-400mA

To measure AC Current greater than 400mA, do the following:

1. Press **I** button to set measurement type to **AC Current**,
2. Press **F3** to select **A** range, the measurement unit will change into **A** accordingly.
3. Plug 4A current divider module (UT-M04) properly into input terminals COM and V/ Ω , then insert Black and Red test leads correspondingly into the module.
5. Connect test leads to tested points, then take the AC current reading.

Warning: If test leads are connected to V/ Ω and COM terminals without use of 4A current module (UT-M04) when measuring the current greater than 400mA, the fuse in the product will be burnt out. Please have the fuse replaced by qualified personnel if the incident happens.

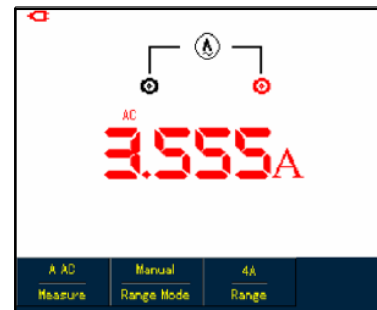

Figure 5-20 Measuring AC Current Greater than 400mA

Data Hold

You can freeze the displayed readings any time as you want.

1. Press **[RUN/STOP]** to freeze measuring values, and **HOLD** icon blinks on the display .
2. Reprress **[RUN/STOP]** to restore the measurement.

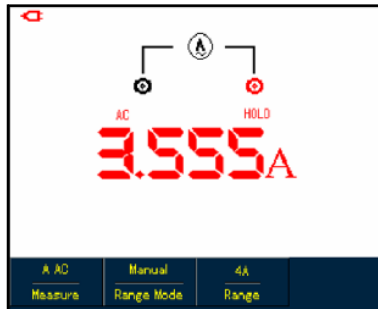

Figure 5-21 Freezing Measurement Values

Making Relative Measurement

Relative measurement displays a current measuring result relative to the specific reference value.

Refer to capacitance measurement in relative mode. First of all you need to obtain a reference value:

1. Press **[R]** button to set measurement type to **Resistance**.
2. Press **[F1]** button to select **Capacitance** option
3. Connect test leads to input terminals (Black to COM and Red to V/ Ω)
4. Wait until the reading becomes stable, then press **[F2]** button to access the relative mode, Δ icon shows on the upper display and the reference value appears just below Δ icon.
5. Connect test leads to the capacitor under test, then take capacitance reading on the display.



Figure 5-22 Measuring Capacitance in Relative Mode

Selecting Manual/Auto Ranging

The multimeter defaults at auto mode. To access manual ranging, operate as follows:

1. Press **[V]** or **[R]** button, and measure mode option is **AUTO**.
2. Press **[F2]** to select manual measure mode, then the ranging mode will change into **Manual**

status accordingly.

3. Under manual ranging mode, keep pressing **[F3]** button to reach up to the highest range, after that, then the selected range jumps directly to the lowest range and circulates again. The currently selected range shows just above measuring readings.
4. Press **[F2]** button, Auto icon shows on left upper display, indicating the multimeter has returned to full autoset mode.

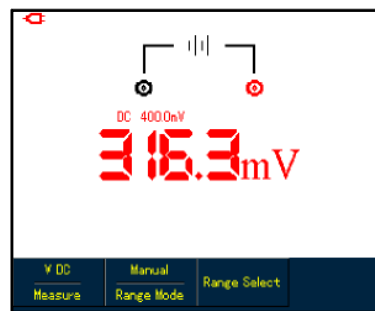

Figure 5-23 Manual Ranging

Chapter 6 Using the Oscilloscope in Details

About the Chapter

This chapter offers a step-by-step introduction on UTD1000L Series functions. Detail information about functional buttons on the front panel and operation examples are included here. It is recommended that you should read through this chapter in order to get more and systematic knowledge of the Oscilloscope.

Setting Vertical System

UTD1000CL Channel Setup

The channel is designed with independent setup menu, press **CHANNEL** button to display the operating menu shown as below:

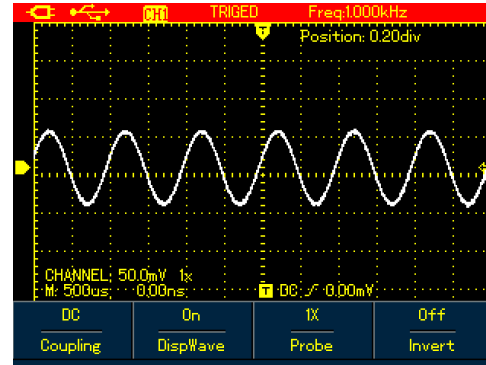

Figure 6-1A Channel Setup Menu

See Channel Menu in Following Table:

Table 6-1A

Coupling	DC AC Ground	AC&DC components pass DC component is blocked Display DC level when the channel input terminal is equivalently grounded.
Wave Display	On Off	To display the channel waveform To turn off the channel waveform display
Probe Factor	1× 10× 100× 1000×	Select one of them to match to the probe, to ensure accurate reading. Four types are available:1×、10×、100×、1000×.
Invert	Off On	To display the waveform normally. To invert the waveform display

Moving Waveform Vertically

When UTD1000CL channel marker turns solid, press Up and Down arrow buttons to move the waveform vertically.

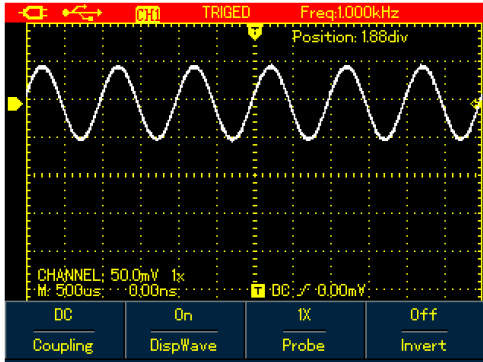

Figure 6-2A Moving Waveform Vertically

Note: if the channel marker is internally empty, press **SELECT** button to access the solid status before moving the waveform vertically.

Setting waveform display

Open the channel menu, and then press F2 button to turn on/off waveform display

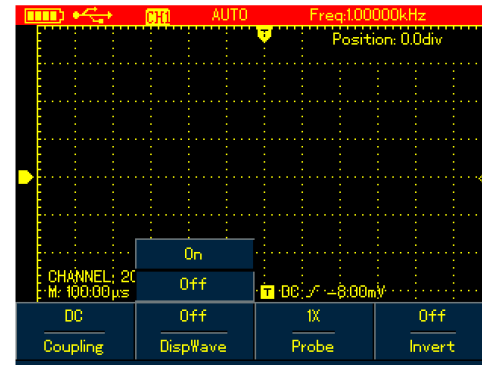

Figure 6-3A Turn off Waveform Display

Set Probe Factor

To match with the probe factor on the probe, you need to set up corresponding factor in channel menu. For example, the probe factor is 10:1, please set Probe option in the menu to 10×. Do the same setting for other selected probe factor in order to ensure accurate voltage reading.

Under channel menu, press **F3** under channel menu to set up probe factor. Probe Attenuation Factor VS Menu Option, see following table:

Table 6-2A

Probe Attenuation Factor	Menu Option
1:1	1×
10:1	10×
100:1	100×
1000:1	1000×

UTD1000DL Channel Setup

The channels have their own setup menus. Repeat pressing **CHANNEL** to toggle between **CH1** and **CH2** menus and display corresponding menu options as shown below:

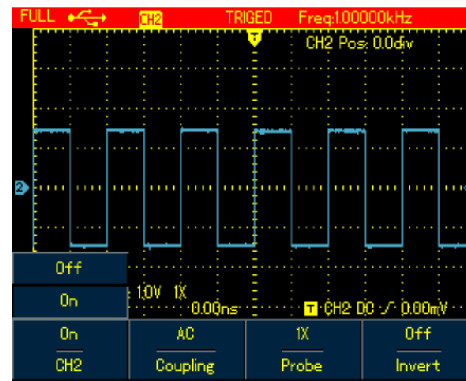

Figure 6-1B Channel Menu Setup

Please see channel menu in the following table:

Table 6-1B

Channel	Off On	Turn off CH1 or CH2 waveform Turn on CH1 or CH2 waveform
Coupling	DC AC GND	AC&DC components pass DC component is blocked Display DC level when the channel input terminal is equivalently grounded.
Probe Factor	1× 10× 100× 1000×	Select one of them to match to the probe, to ensure accurate reading. Four types are available: 1×、10×、100×、1000×.
Invert	Off On	To display the waveform normally. To invert the waveform display

1. Moving Waveform Vertically

Use Up and Down buttons to move the current waveform vertically when the channel marker becomes solid. If you want to move the waveform from another channel, please press **CHANNEL** button again before moving the waveform.

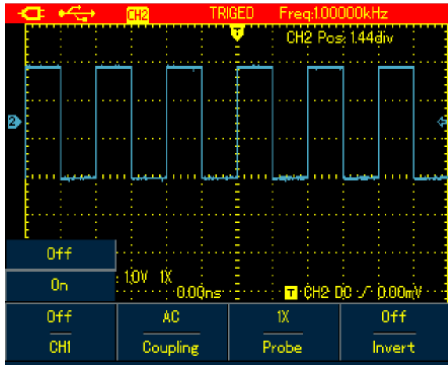

Figure 6-2B Moving Waveform Vertically

Setting Waveform Display

Press **CHANNEL** button to toggle between different channels. In the channel menu, press **F1** submenu button to turn on/off the waveform of the current channel. In order to on/off another channel waveform, you need to press **CHANNEL** button again before pressing **F1** button

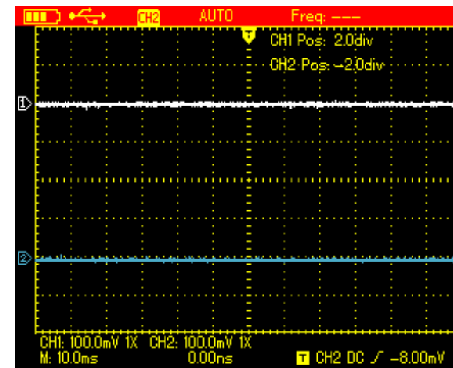

Figure 6-3B Turn on Waveform Display for Dual Channels

Setting Probe Factor

To match with the probe factor on the probe, you need to set up corresponding factor in channel menu. For example, the probe factor is 10:1, please set Probe option in the menu to 10×. Do the same setting for other selected probe factor in order to ensure accurate voltage reading.

Under channel menu, press F3 to set up probe factor. To set up probe factor for another channel, please press **CHANNEL** again and then the **F3** button.

Probe Attenuation Factor VS Menu Option, see following table:

Table 6-2B

Probe Attenuation Factor	Menu Option
1:1	1×
10:1	10×
100:1	100×
1000:1	1000×

Setting Horizontal System

Changing Timebase

Press s/ns button slow down or speed up the scan rate from 10ns or 5ns/div~50s/div.

Notes: For 25MHz-bandwidth models: 10ns/div~50s/div; 50MHz-bandwidth Models: 5ns/div~50s/div.

Moving Waveforms Horizontally

Press Left and Right buttons to adjust pretrigger depth. The trigger location is usually set at horizontal center on the screen. With the adjustment, you can observe 6div pretrigger and delay data. Through moving the waveform horizontally, more trigger information can be viewed, which let users know more about pretrigger situation. For instance, by observing and analyzing pretrigger data of glitches occurring in circuit start-up, you can trace down the cause to the glitches.

Press **HORIZONTAL** button to switch on horizontal menu, refer to the following figure:

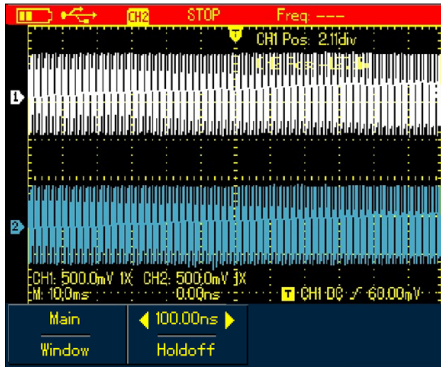

Figure 6-4 Horizontal Setup Menu

There are two options in horizontal menu: Window and Hold-Off

Zooming in/out Waveforms

Switch on horizontal menu and press **F1** button to zoom in one segment of the waveform. The timebase for expanded window shouldn't be lower than that of main window. Note: Timebase faster than 100ns cannot enter into expanded window.

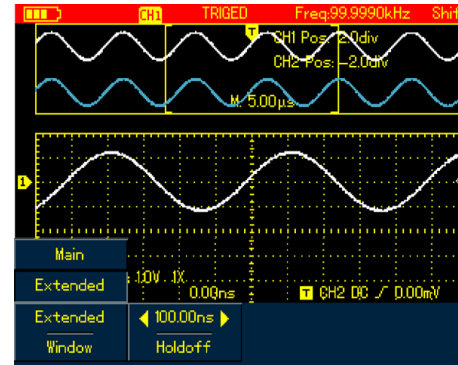

Figure 6-5 Screen Display under Window Zoom

Under window zoom function, there are two separate display zones as indicated in the figure above. The upper part is for the original waveform. Press **OK** button and then use **Left and Right** buttons to select the waveform to be expanded on the left or right, or enlarge or narrow down the selected zone with **s/ns** button.

The lower display is for the expanded waveform corresponding to the selected original zone. One point worth mentioning is that compared with the main timebase, the expanded timebase has improved the resolution for the waveform display (See Figure 6-5). Since the displayed waveform corresponds to the selected zone of upper part, using **s/ns** button to narrow down the selected zone can enable the expanded waveform to have better timebase, namely, a higher waveform amplification factor in a horizontal direction.

Adjusting Trigger Hold-Off

Switch on horizontal menu, use **Right and Left** buttons to adjust hold-off time (100ns-1.5s). It can be applied to observe complex waveforms (eg: burst). Hold-off time is to adjust data acquisition period of the oscilloscope to stay in a integral multiple related to the period of complex waveform so that the Oscilloscope and complex waveform can synchronize.

For example, apply tested combined signals into Ch1. Press **HORIZONTAL** to turn on horizontal menu, then press **Right and Left** buttons to adjust the hold-Off time until displayed waveform become stable. See Figure 6-6:

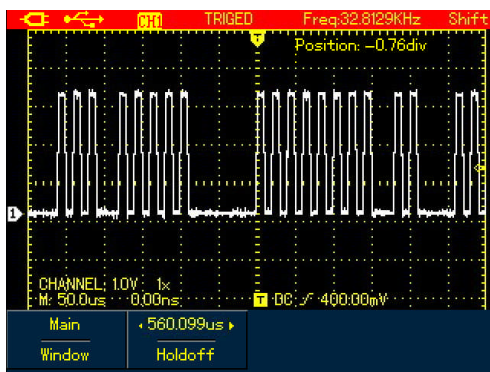

Figure 6-6 Trigger Hold-Off

Note:

1. The trigger hold-off time can be adjusted only when horizontal menu displays.
2. Generally hold-off time is a little smaller than “Big Period”, for instance for RS232 communication signal waveform, hold-off time should be a little larger than start edge time of each frame in order to easily observe the waveform.

Setting Trigger System

Trigger system determines when the Oscilloscope starts to acquire data and display waveforms. Once the trigger is properly set, the Oscilloscope can transform unstable signal into meaningful waveform. When the acquisition starts, the Oscilloscope continuously acquires enough data to fill the pretrigger portion that is displayed to the left of trigger point. Then the trigger occurs, the Oscilloscope will continue to acquire enough data to fill the posttrigger waveform to the right of trigger point. **TRIGGER** button is designed to set up the Oscilloscope trigger functions.

TRIGGER: Trigger menu button
Trigger Level: to set up signal voltage that corresponds to the trigger point.
 Press **TRIGGER** button to turn on trigger menu as indicated in the figure below, then press **F1** button to switch between different trigger types.
 Press **F2** to select trigger source.

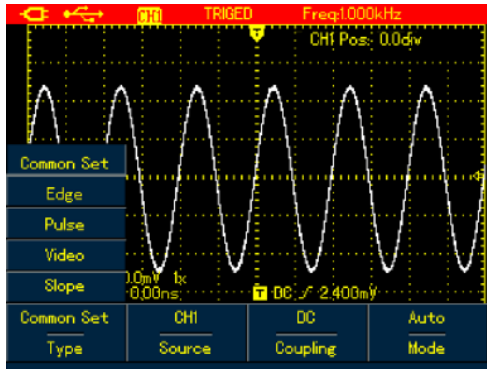

Figure 6-7 Trigger Menu

Trigger Controls

Four trigger types are available: edge, video, pulse width and slope, every of which is coupled with different functional menu. There is still one type—common setting—used to set up trigger source, trigger coupling and trigger modes.

Edge Trigger: Trigger on rising or falling edge. You can adjust trigger level to change vertical

location on the edge for trigger point, that is the cross point between trigger level line and the signal edge on the screen.

Pulse Width Trigger: Trigger when the pulse width of trigger signal reaches up to preset trigger conditions.

Video Trigger: Trigger on fields or lines of standard video signal.

Slope Trigger: Use the rise or fall speed rate of the signal as trigger condition.

Check details for different kinds of trigger menus

Common Setting

Common Setting is used to set up common trigger items, refer to the table below for details:

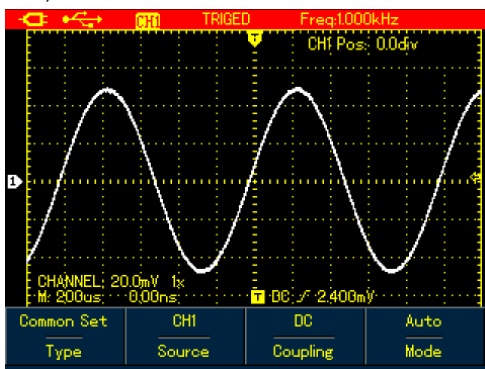

Figure 6-8 Trigger -- Common

Table 6-3

Menu	Settings	Description
Type	Common	to set up common trigger items
Source	CH1 CH2	Set CH1 as trigger source Set CH2 as trigger source
Coupling	AC DC HF Reject	DC component is blocked DC & AC components pass Reject high frequency component at >80kHz
Mode	Auto Normal	The Oscilloscope automatically acquires data when no trigger signal has been detected. Acquire waveform only when the trigger condition is met;

Note:

To set up the common setting, shortcuts are also available to execute the operation:

1. Press **[SHIFT]** button, Shift icon displays on right upper corner of the screen;
2. Press **[F1]** / **[F2]** / **[F3]** / **[F4]** button to display common setting menu.

Edge Trigger

Edge trigger is to trigger on trigger threshold value of signal edge. Please see the table below for edge trigger menu:

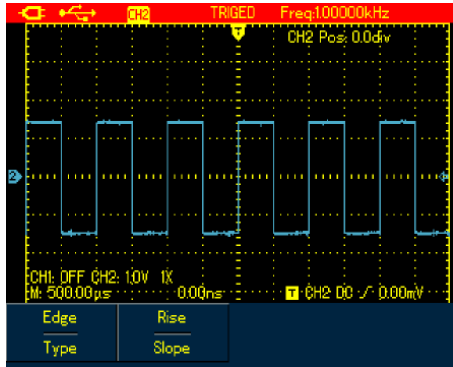

Figure 6-9 Trigger-Edge Type

Table 6-4

Menu	Settings	Description
Type	Edge	Set trigger Type to Edge.
Slope	Rise	Set to trigger on rise edge of signal.
	Fall	Set to trigger on fall edge of signal.

Pulse Width Trigger

It determines the trigger time based on pulse width, which helps you to capture abnormal pulse by setting specific pulse width conditions.

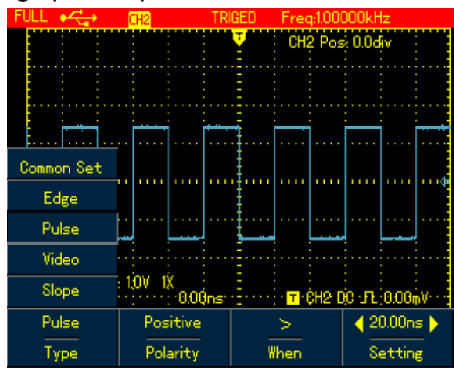

Figure 6-10 Trigger-Pulse Width Type

Table 6-5

Menu	Settings	Description
Type	Pulse Width	Set trigger Type to Pulse Width
Polarity	Positive Negative	Set positive pulse width as trigger signal. Set negative pulse width as trigger signal.
Qualifier	= < >	Trigger when input pulse width equals to set value; Trigger when input pulse width is less than set value; Trigger when input pulse width is greater than set value;
Time	---	To set up pulse width time value, use Left and Right arrow buttons to set the value when the menu is displayed.

Video Trigger

Trigger on fields or lines of NTSC or PAL standard signals if video trigger is selected.

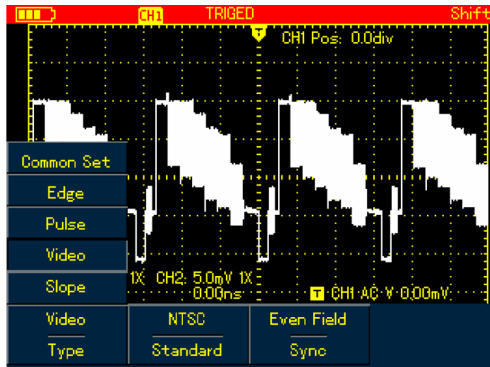

Figure 6-11 Trigger–Video Type

Table 6-6

Menu	Settings	Description
Type	Video	Set trigger Type to Video.
Format	PAL	Trigger on PAL format video signal.
	NTSC	Trigger on NTSC format video signal.
Syn	All Lines	Trigger synchronically on all lines.
	Odd Field	Trigger on odd fields.
	Even Field	Trigger on even fields.

Slope Trigger

Trigger occurs only after rise or fall speed rate meets set value.

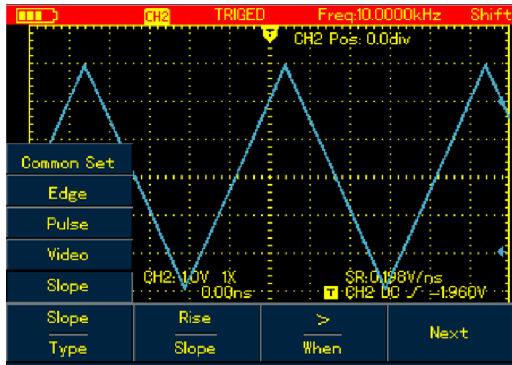

Figure 6-12 Trigger-Slope Type (Page 1)

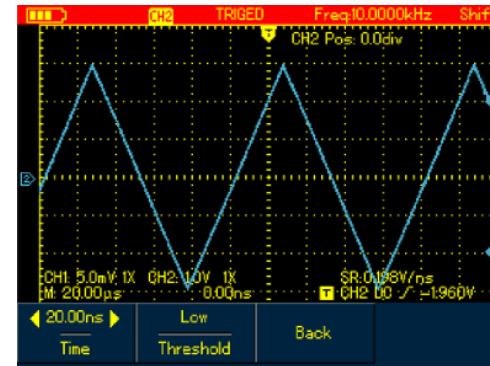

Figure 6-13 Trigger - Slope Type (Page 2)

Table 6-7

Menu	Settings	Description
Type	Slope	Set trigger Type to Slope
Slope Type	Rise Fall	Trigger on rising edge that traverse between thresholds. Trigger on falling edge between thresholds
Qualifier	> < =	Trigger When the slope is greater than the set value of slew rate. Trigger When the slope is less than the set value of slew rate. Trigger When the slope equals to the set value of slew rate.
Next	----	Page 2 of Slope Menu
Slew Rate	----	To set up slew rate value, use Left and Right arrow buttons to pulse width time when the menu is displayed.
Threshold	Low High Low&High	Use Up and Down buttons to move low-level threshold Use Up and Down buttons to move High-level threshold Use Up and Down buttons to move low-and high-level thresholds.
Back	----	To return to Page 1 of Slope Menu.

Term Explanation

1. **Trigger Source:** Input channel is used as the trigger source

■ **Input Channel:** Input channel (CHI) is the most commonly used trigger source. For the channel selected as the trigger source, it should be switched on before it works normally.

2. **Trigger Mode:** decide what the oscilloscope will do when no trigger event occurs. Three trigger modes are offered: Auto, Normal and Single.

■ **Auto:** The system automatically acquires data even there is no signal input and therefore displays scan reference line on the screen; when the trigger occurs, it converted into trigger scanning and synchronizes with the signal on its own.

Note: The Oscilloscope will go into SCAN mode if waveform scan rate is set at 50ms/div or lower timebase.

■ **Normal:** Under this mode, the Oscilloscope

acquires the waveform only after the trigger conditions are met. It stops to acquire and keeps waiting if no signal is input. Once the trigger occurs, the scan starts.

■ **Single:** You just need to press **RUN** button if under single mode, then the Oscilloscope waits to trigger. It begins to acquire and display all acquired waveforms once single-shot trigger signal is detected, after that, it stops.

3. **Trigger Coupling:** To decide to pass which kind of components through the trigger circuits. The types include: DC, AC and Hf Reject.

■ **DC:** passes through all components of the signal

■ **AC:** blocks DC component and attenuate signals at <10Hz

■ **HF Reject:** attenuates high frequency component at >80kHz

4. Pretrigger/Delay Trigger: Capture data before /after the trigger event. The trigger is usually located at the horizontal center point on the screen, for example, you can observe 6div pretriger and delay information, adjusting the waveform horizontally can let you view on more pretrigger information. Pretrigger can indicate what the waveform is like before the trigger event. So this function can make it easy, for instance, to find out the cause of glitches in start moment of circuits through observing and analyzing pretrigger data.

Setting Acquisition Mode

Press **ACQUIRE** button to access acquisition mode, see the following table:

Table 6-8

Menu	Settings	Description
Mode	Normal Peak Detect AVG	Set to normal sampling Set to Peak Detect mode, Set to AVG sampling mode
AVG Number (only displayed under AVG mode)	2~256	To set AVG times, stepping in multiples of two, that is from 2, 4, 8, 16, 32, 64, 128, 256 to 512, turnLeft and Right arrow buttons to change average times in displayed menu.

Note:

1. Use normal mode when you observe single-shot signal.
2. Please select Peak mode if you want to observe signal envelope and also to avoid any mix-up

Term Explanation

Normal Mode: The Oscilloscope samples the signals at equal time interval to create the waveform on the display.

Peak Detect: Under this mode, the Oscilloscope uses Max. and Min. values detected in each sampling interval to form waveform on the display. It is suitable to capture and display narrow pulse which may probably be neglected if using Normal mode. However the noise under Peak Detect sounds louder.

AVG Mode: The Oscilloscope captures certain numbers of waveforms and calculates their average values that will be used to form waveforms on the display. This mode can reduce random noise.

Fast Acquisition: it only acquires points for Min. memory depth required for display, which can shorten the hold-off time between each acquisition and realize superb capture rate. It can significantly increase the possibility to find out rarely seen issue.

Setting the Display

Press **DISPLAY** button to access display menu, please refer to the follow table:

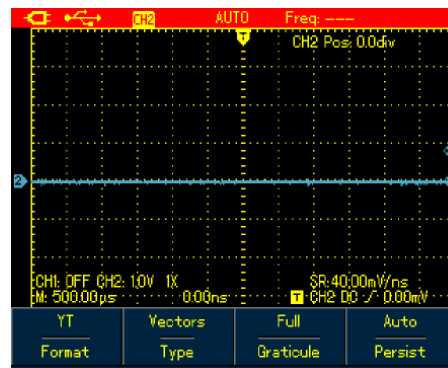

Figure 6-14 Waveform Display Setup

Table 6-9

Menu	Settings	Description
Format	YT XY	To display relationship between voltage(vertical) and time(Horizontal). X-Y display mode using Ch1 signal to form X axis and Ch2 signal for Y axis (applicable only for dual channel model)
Format	Vector Dots	Connect sample dots and display. Directly display sample dots
Graticule	Full Grid Cross Hair	To set the graticule of waveform display zone to Full, Grid and Cross Hair mode
Persist	Off 1s 3s 5s Infinite	Update the waveforms at normal rate. Update after waveform data is hold for 1 second. Update after waveform data is hold for 3 seconds. Update after waveform data is hold for 5 seconds, Waveform data is kept on the screen, new data, if any, could be added into the display continuously.

Term Explanation:

Display Format: **VECTOR** Display fills out all blanks between neighboring points, **DOT** Display just shows sample points.

Update Rate: The times that the oscilloscope updates the waveforms per second. it reflect how fast the Oscilloscope could allow you to observe signal dynamic change.

Y-T Mode: In this mode, Y axis represents voltage and X axis for the time.

Slow Scan Mode: When the timebase is set at 50ms/div or lower, the Oscilloscope will enter into slow scan mode. This mode is applied to observe low-frequency signal. It is recommended that channel coupling is set to **DC**.

Setting Auto Measurements

The section below introduces in details the powerful auto measurement function owned by the Oscilloscope. Press **MEASURE** button to open auto measurement menu, see the table below:

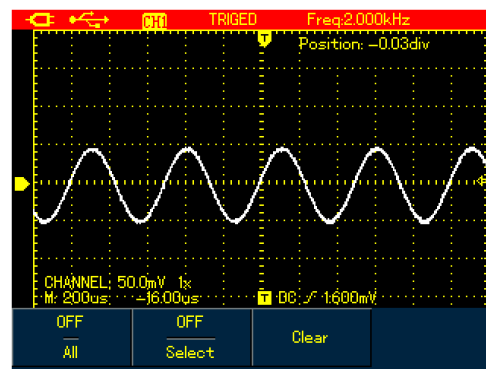

Figure 6-15A UTD1000CL Auto Measurement Menu

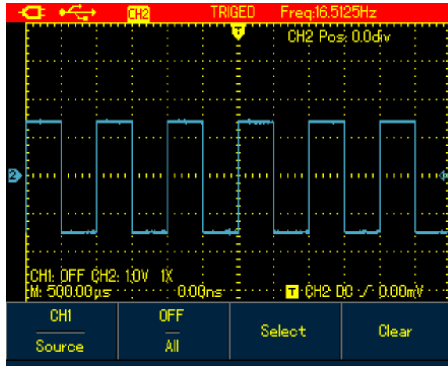

Figure 6-15B UTD1000DL Auto Measurement Menu

Table 6-10

Menu	Settings	Description
Source	CH1	Select CH1 as the signal source.
	CH2	Select CH2 as the signal source.
All	ON	To measure all parameters.
	OFF	Turn on auto measurement function.
Select	ON	To select the parameters to be measured by using SELECT button. The selected parameter will be displayed on the screen. Max.4 items can be chosen at a time.
	OFF	Turn off customized parameter selection box
Clear	---	To clear the displayed customized parameter

Case 1: To display all measurement parameters of the displayed channel, do the following:

1. Press **[MEASURE]** button to open parameter measurement menu;
2. Press **[F1]** of UTD1000CL (**[F2]** of UTD1000DL) to set All option to On;

Then all measurement parameters display on the screen. See the Figures below:

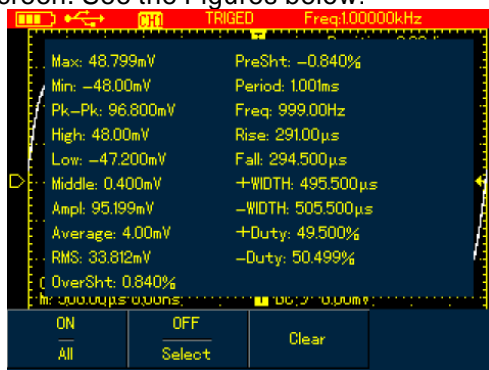

Figure 6-16A UTD1000CL measures all parameters

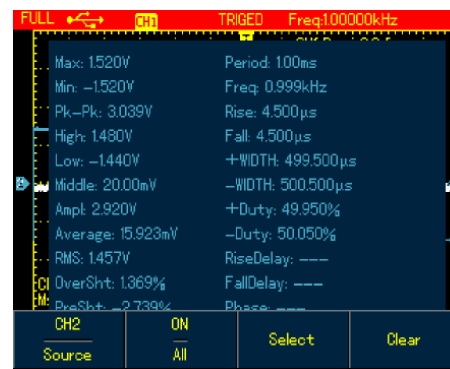

Figure 6-16B UTD1000DL measures all parameters

Case 2: To measure Vpp and Amplitude parameters, do the following:

1. Press **[MEASURE]** to open parameter measurement menu;
2. Press **[F2]** of UTD1000CL (**[F2]** of UTD1000DL) button to open parameter selection box;
3. Press Arrow Buttons to select Vpp parameter;

4. With Vpp parameter chosen, press **SELECT** to confirm; and one marker will appear on the front of Vpp parameter to indicate it has been successfully selected, the parameter will show on the display accordingly.
5. Do the same to select Amplitude parameter;
6. Press **SELECT** to confirm, one marker also show on the front of Amplitude parameter, and then the parameter displays on the screen.
7. Press **F2** of UTD1000CL (**F3** of UTD1000DL) to turn off parameter selection box; See the following figures for Vpp and Amplitude parameters displayed on the upper right part of screen:

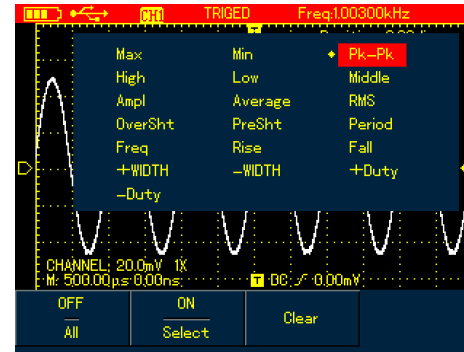

Figure 6-17 Select Vpp Parameter

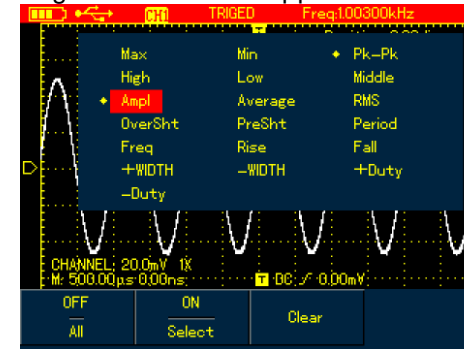

Figure 6-18 Select Amplitude Parameter

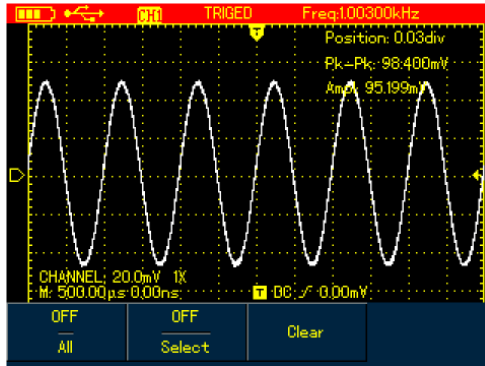

Figure 6-19 Display Selected Parameters

Note: Parameter selection is to measure parameter immediately. There are 19 types of parameter measurements for UTD1000CL and 22 types available in UTD1000DL. Under general circumstances, not all parameters, but just some of them are required to be measured. Therefore the users can customize their measurements as expected. The software can select up to 4 parameters displayed on the screen.

Auto Parameter Measurements

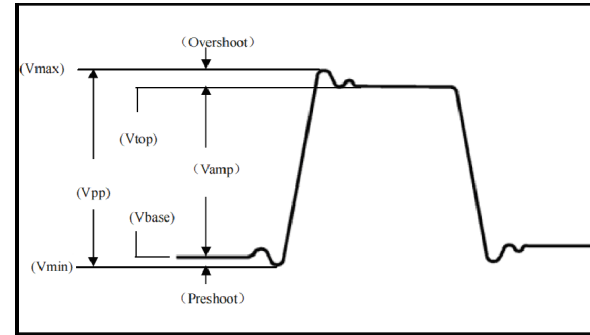

Figure 6-20 Voltage Measurement

The voltage parameters that the Oscilloscope can automatically measure include:

Maximum Value (Vmax) : Voltage measured from the highest point of waveform to the zero ground

Minimum Value (Vmin) : Voltage measured from the lowest point to the ground

Top Value (Vtop) : Voltage measured from the flat top to the ground.

Base Value (Vbase) : Voltage measured from the base of the waveform to the ground

Middle Value (Vmid): a half of amplitude value

Peak-to-Peak Value (Vpp) : Voltage measured from the highest point to the lowest point of waveform

Amplitude (Vamp) : Voltage measured from the top to the base of the waveform

Overshoot: $(\text{Maxi-Top}) / \text{Amplitude} \times 100\%$

Preshoot: $(\text{Min-Low}) / \text{Amplitude} \times 100\%$

Average Value: The arithmetic mean over one cycle in the waveform

RMS Value (Vrms) : Effective value, the root mean square voltage over one cycle in AC signal waveform that corresponds to DC voltage with equal generated energy calculated in this cycle.

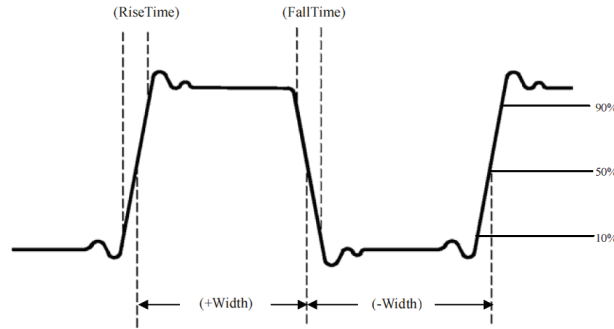

Figure 6-21 Time Measurement

The time parameters the Oscilloscope can automatically measure contain:

RiseTime: The time required to rise from 10% to 90% of waveform amplitude.

FallTime: The time required to fall from 90% to 10% of waveform amplitude.

Positive Pulse Width (+Width) :

The distance between the mid (50%) amplitude points of a positive pulse.

Negative Pulse Width (-Width) :

The distance between the mid (50%) amplitude points of a negative pulse.

Rising Delay: The delay time between rising edges from A to B

Falling Delay: The delay time between falling edges from A to B

Positive Duty Cycle (+Duty) : the ratio of positive pulse width to the period.

Negative Duty Cycle (-Duty) : the ratio of negative pulse width to the period.

Recording and Storage

Recording

Press RECORD button to open waveform record menu. There are two independent menus shown as below:

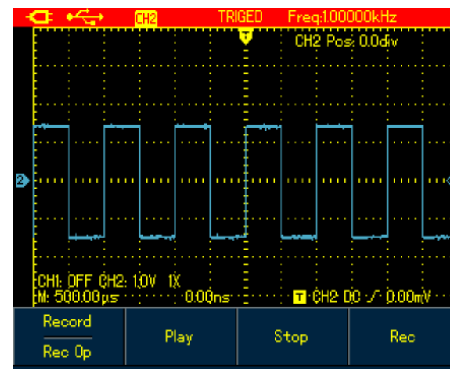

Figure 6-22 Waveform Record Menu

Set up as the following table:

Table 6-11 Record Menu

Menu	Settings	Description
Wave Record	Record	To turn on/off waveform record function.
Play	----	To play recorded waveform
Stop	----	To stop recording or playing waveforms
Record	----	To begin the recording.

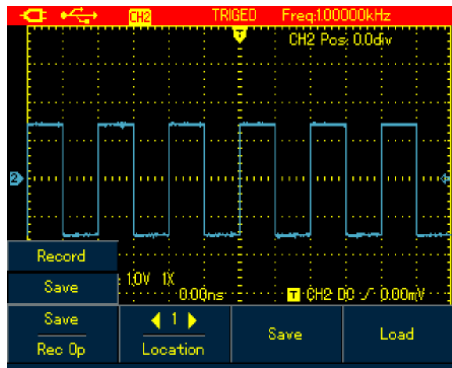

Figure 6-23 Save Menu for Recorded Waveforms

Table 6-12 Save Menu for Recorded Waveforms

Menu	Settings	Description
Wave Record	----	There are 1-5 location options available, use arrow buttons to select when the menu displays
Save	----	To save recorded waveform to internal memory.
Recall	----	To recall the waveform record that is saved in internal memory

Note: You can also save the recorded waveform to PC using the control software and play it on PC.

Case 1: To record channel waveforms and save them to the internal memory, do the following:

1. Press **[RECORD]** button to access record menu;
2. Press **[F1]** to set to Record option;
3. Press **[F4]** to begin recording. To stop recording, press **[F3]** button;

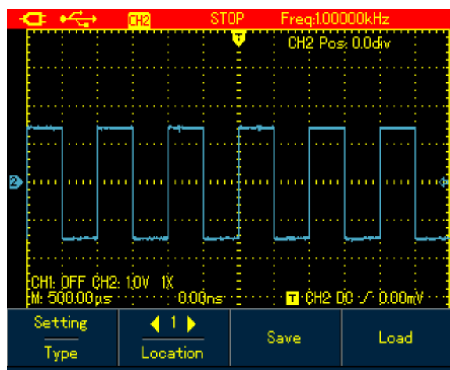

Figure 6-25 Setting Waveform Storage Menu

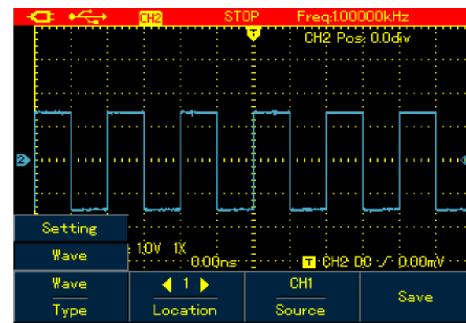

Figure 6-26B UTD1000DL Waveform Storage Menu
Set up the storage menu as follows:

Table 6-13

Menu	Settings	Description
Type	Setup Waveforms	To save current setups of menus; To save channel waveforms
Location	1-20	Use arrow buttons to select storage location.
Source	CH1 CH2	To select the channel of the saved waveform.
Save	----	To save the selected items.
Recall(refer to the following section for recall setup)	----	To recall the saved parameters when the menu is on.

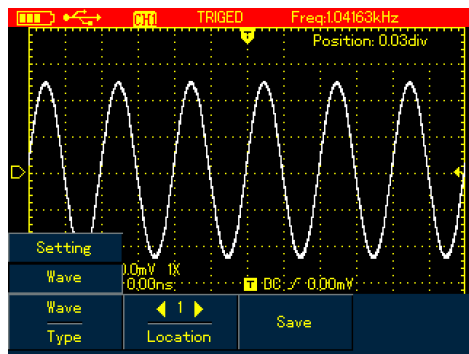

Figure 6-26 UTD1000CL Waveform Storage Menu

4. Press **[F1]** to set to Save option ;
5. Use Arrow Buttons to set the location to 1 ;
6. Press **[F3]** to save the recorded waveform, “Saving…” shows on the screen. When “Saving…” icon disappears, it indicates the waveforms have already been saved into internal memory.

Note: Model UTD1000CL can record up to 300 screens of waveforms, and it is up to 150 for Model UTD1000DL. If following operations are performed during recording, the recording will stop.

- Press **RUNSTOP/SINGLE** button ;
- Press **AUTO** or **SHIFT+AUTO** button
- Turn Timebase range to access **SCAN** mode.

Case 2: To recall recorded waveform in Case 1 from the internal memory and replay it, do the following:

1. Press **RECORD** to access record menu ;
2. Press **[F1]** to set to Save option ;
3. Press Arrow Buttons to set Location to 1
4. Press **[F4]** to begin recalling, “loading…” indicates on the screen, after the loading

finishes, “Load Success” indicates.

5. Press **[F1]** to set to Record option ;
6. Press **[F2]** button to begin playing the recalled waveforms automatically, press **[F3]** to stop or use Arrow Buttons to select the waveform to be played.

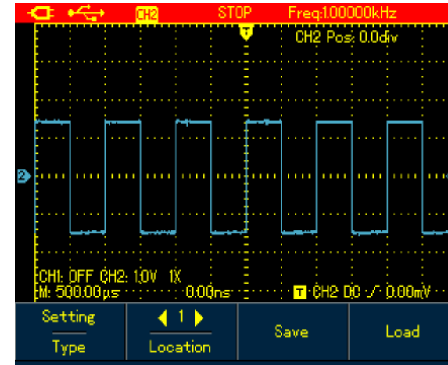

Figure 6-24 Replay Waveform Record Storage

To store the waveforms, do the following:

1. Press **SHIFT** button, and shift icon shows on upper right part of screen ;
2. Press **STORAGE** button to access storage menu ;

Recalling

To recall the waveforms, press **SHIFT** button and shift icon shows on the upper right part of screen; then press **REF** to access waveform recall menu.

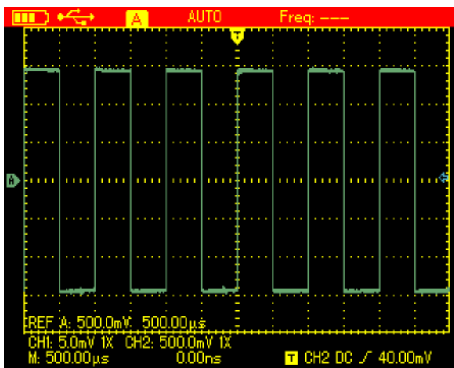

Figure 6-27 Recall Reference Waveforms

Set up as shown in the following table:

Table 6-14

Table 6-14

Menu	Settings	Description
Ref Wave	REF A REF B	Model UTD1000CL default at REFA option UTD1000DL can recall REFA or REFB individually or both of them at the same time.
Location	1-20	Use Right and Left buttons to select the location to be recalled.
Recall	----	To begin the recalling
Clear	----	For Model UTD1000CL, it's used to turn off recalled waveform; For Model UTD1000DL, it's used to turn off current waveform(REFA or REFB)

Case 1: To save and recall channel waveforms to the internal channel:

Saving Waveforms

1. Press **[SHIFT]** and shift icon shows on upper right part of screen;
2. Press **[STORAGE]** to access storage menu;
3. Press **[F1]** to set **Type** to **Waveform**;
4. Press **Left&Right** buttons to set Location to 1; press **[F3]** to select target Source; (Only available in UTD1000DL)
5. Press **[F3]** of UTD1000CL to save, and also **[F3]** button for UTD1000DL, then “storage success” shows on the display, indicating the waveform has been successfully saved into the Oscilloscope;

Recalling Waveform

6. Press **[SHIFT]**, shift icon shows on upper right part of display.
7. Press **[REF]** to access waveform recall menu;
8. Press **[F1]** of UTD1000DL to select between REFA or REFB; UTD1000CL defaults at REFA;
9. Press **[Left & Right]** arrow buttons to set Location to 1;
10. Press **[F3]** to recall, “Load Success” will show to indicate the waveform has been successfully displayed on the screen too;
11. Press **[F4]** to turn off the current reference waveform.

Making Cursor Measurements

To make cursor measurements, do the following:

1. Press **[SHIFT]** and shift icon shows on upper right part of display.
2. Press **[CURSOR]** to access cursor menu;
3. Press **[F2]** of UTD1000DL to choose the channel for cursor measurement (No selection for UTD1000CL, it defaults at CH1)
4. Press **[F1]** to set up measuring type.

There are two options available for measuring Type in cursor menu: Voltage and Time.

When measuring voltage, use **[SELECT]** and arrow buttons to adjust the locations of two cursors in order to measure ΔV parameter, do the same with Δt measurement.

Voltage/Time Measurement Tips: Cursor 1 and Cursor 2 shows simultaneously on the screen, use arrow buttons to remove the cursors and press **[SELECT]** to choose and adjust the desired one. Displayed readout is the voltage or time

between two cursors.

When the cursor function turns on, measuring values can be automatically shown on upper left corner of the display.

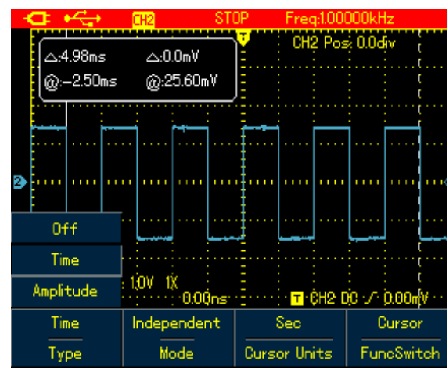

Figure 6-28 Cursor Menu for Time Measurement

Table 6-15

Menu	Settings	Description
Type	Time	Use the cursor to measure the time
Mode	Independent	Move each cursor independently
	Tracking	Move two cursors simultaneously and keep Δt unchanged
Vertical Unit	Sec	measurement parameter is time
	Hz	measurement parameter is frequency
Func Switch	Channel	Use arrow buttons to set the target to channel waveform;
	Trigger	Use arrow buttons to set the target to trigger level;
	Cursor	Use arrow buttons to set the target to the cursors, press SELECT to select between Cursor 1 and Cursor 2.

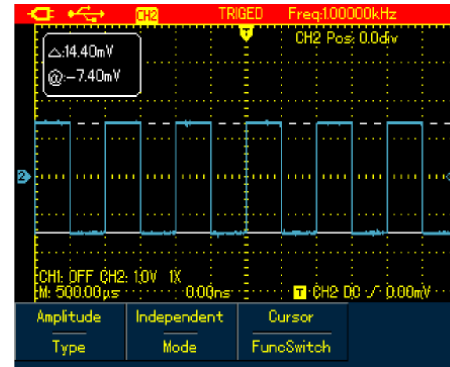

Figure 6-29 Cursor Menu for Voltage Measurement

Table 6-16

Menu	Settings	Description
Type	Voltage	Use the cursor to measure the voltage
Mode	Independent	Move each cursor independently
	Tracking	Move two cursors simultaneously and keep ΔV unchanged
Func Switch	Channel	Use arrow buttons to set the target to channel waveform;
	Trigger	Use arrow buttons to set the target to trigger level;
	Cursor	Use arrow buttons to set the target to the cursors, press SELECT to select between Cursor 1 and Cursor 2.

Interface Setup

To set up the display interface for the Oscilloscope, do the following:

1. Press **SHIFT**, shift icon shows on upper right corner of display.
2. Press **CONFIGURE** to enter into display configuration menu;

Table 6-17

Menu	Settings	Description
Language	Multilingual	To select the desired language
Style	Classic, Traditional, Modern, White&Black	To select display style
Menu Display	----	To set up waiting time before the manual turns off: 5s, 10s, 20s, Manual, Manual—the menu will not turn off automatically, use OK to turn it on/ off.
System Info	----	To display oscilloscope model, hardware version, software version, etc;

Utility Setup

To set up the display interface for the Oscilloscope, do the following:

1. Press **SHIFT**, shift icon shows on upper right corner of the display;
2. Press **UTILITY** to access Utility menu.
Menu Setup shown as in the following table:

Table 6-18

Model UTD1000CL		
Function menu	Settings	Description
Self-Calibr	-----	The Oscilloscope will calibrate the system automatically.
Default	-----	The Oscilloscope returns to factory default status.
Freq Counter	On/Off	Turn on /off trigger frequency counter.
Clear	-----	Clear saved or recorded waveforms or settings in the Oscilloscope, etc ;

Model UTD1000CL		
Function menu	Settings	Description
Self-Calibr	-----	The Oscilloscope will calibrate the system automatically.
Default	-----	The Oscilloscope returns to factory default status.
DC Autoset	On/Off	Turn on/off DC signal self-identification function
Clear	-----	Clear saved or recorded waveforms or settings in the Oscilloscope, etc ;

Key Points :

Self-Calibration: You need to run this operation to avoid any measurement error arising from environment change. To ensure an accurate calibration, please power on the Oscilloscope and warm it up for 20 minutes.

Full Autoset: The Oscilloscope can automatically adjust its ranges based on the input signal to present users optimal waveform without any manual interference.

Executing Mathematic Functions

1. For Model UTD1000CL, there is only **FFT** operation available, refer to following displayed menu:

To execute **FFT** operation, do the following:

1. Press **MATH** to open math menu;
2. Press **F1** to turn on FFT operation.

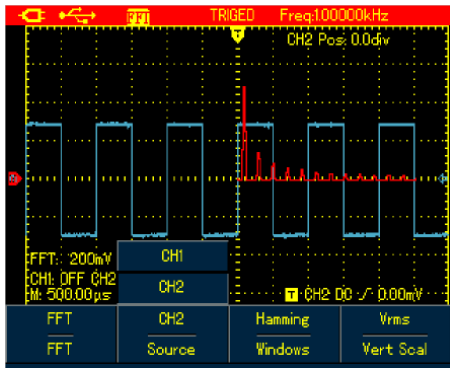

Figure 6-30 UTD1000CL FFT Operation

Table 6-19

Function menu	Settings	Description
FFT	On Off	Turn on/off FFT function.
Source	CH1	CH1 is the default channel for FFT operation.
Window	Hanning Hamming Blackman Rectangle	Set to Hanning window. Set to Hamming window. Set to Blackman window. Set to Rectangle window.
Vertical Unit	Linear dBV	To set vertical unit to linear or dBV

- For Model UTD1000DL, both **FFT** and **MATH** functions are offered:
 Math Operation: It is to execute simple (+, -, ×, ÷) math operations on **CH1** and **CH2** waveforms.

To perform Math or **FFT** operation, do the following:

- Press **MATH** to turn on mathematic menu;
- Press **F1** to Set Type to Math
- Press **F1** again to switch to **FFT** type;

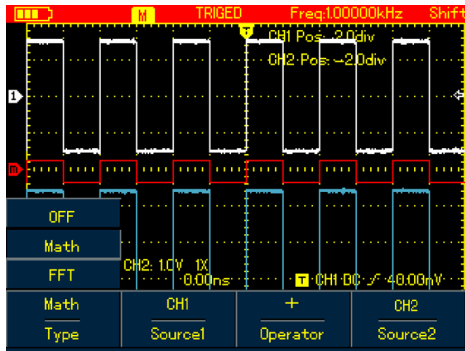

Figure 6-31 UTD1000DL MATH Operation

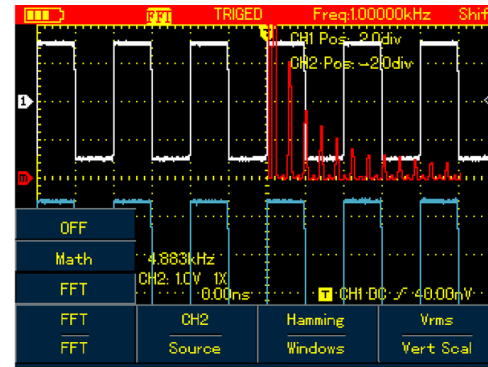

Figure 6-32 UTD1000DL FFT Operation

Set up Math and FFT menus as follows:

Table 6-20

Type	Settings		Description
OFF	----		Turn off MATH function
Math	Source 1	CH1 CH2	Set CH1 as Source 1 of Math operation Set CH2 as Source 1 of Math operation
	Operator	+ - × ÷	Source1+Source 2 Source 1–Source 2 Source 1 ×Source 2 Source 1 ÷Source 2
	Source 2	CH1 CH2	Set CH1 as Source 2 of Math operation Set CH2 as Source 2 of Math operation
FFT	Source	CH1 CH2	Set the source to CH1 Set the source to CH2
	Window	Hanning Hamming Blackman Rectangle	Set to Hanning window Set to Hamming window Set to Blackman window Set to Rectangle window
	Vertical Unit	Linear dBV	To set vertical unit to linear or dBV

FFT Spectrum Analysis

FFT (Fast Fourier Transform algorithm) mode can convert time domain (YT) into Frequency domain for signal waveform graph, which helps to easily observe signals of following kinds:

- Harmonic component and distortion in the measurement system.
- Characterize noises in DC source
- Analyze the vibration

FFT Operation Tips

Signals with DC components or bias may cause error or deviation to **FFT** waveform components. In order to reduce DC component, you can set coupling to AC mode. And you can set **ACQUIRE** type to **AVG** to lower down random noise or mixed overlapped frequency component in repetitive or single pulse event.

Select FFT Window

Suppose YT waveforms repeats constantly and the Oscilloscope then performs **FFT** on limited length record. When the period numbers are integer, YT waveform at the start and finish points share same amplitude values and will not cause any interruption to the waveform. If it is non-integral, the start and finish amplitude are different, and high-frequency transient interruption will happen at joint points, which is called leakage in frequency domain. To avoid the leakage, **FFT** mode will multiply original waveform with one window function to force the start and finish values all go to 0. Refer to following windows for details:

Table 6-21

FFT Window	Features	Best Applications
Hanning	Compared with rectangle type, it has better amplitude accuracy and less so for frequency resolution.	Used to measure sine, periodic and narrowband random noises.
Hamming	Frequency resolution for Hamming is a little better than that of Hanning.	Used to measure transient or short pulse; and for signals whose signal levels before and after the event are greatly different.
Blackman	Offers best amplitude accuracy and worst for the frequency resolution.	Mainly for measuring single frequency signals and looking for higher order harmonics
Rectangle	Offer best frequency resolution, but worst for the amplitude accuracy. No big change before and after adding window function.	Applicable for measuring transient or short pulse, the signal levels before and after the event are approximately equal. And also for measuring equal-amplitude sinewave with very close frequencies, broadband random noise with relatively slow changing spectrum.

Term Explanation

FFT Resolution: defined as Quotient between sample rate and operation points. When operation points are fixed, the lower sample rate is, the better **FFT** resolution will be.

NYQUIST Frequency: For waveforms with highest frequency f , it at least needs to apply $2f$ sample rate in order to recreate original waveform. It is called **NYQUIST** principle. f is **NYQUIST** frequency and $2f$ is **NYQUIST** sample rate.

Autoset

Autoset is used to simplify the operations. Press **AUTO** button and then the Oscilloscope will automatically adjust vertical factor and timebase range based on the waveform amplitude and frequency until the waveform displays steadily on the screen. System settings for Autoset function are shown in the following table:

Table 6-22

Functions	Settings
Acquire Mode	Normal Sample
Display Type	YT
SEC/DIV	Adjust based on signal frequency
VOLT/DIV	Adjust based on signal amplitude
Trigger Type	Edge
Trigger Level	central point of signal
Trigger coupling	DC
Trigger Slope	Rise
Trigger Mode	Auto

Chapter 7 Troubleshooting

The Oscilloscope cannot power on:

The battery may run out. Try to power on the Oscilloscope again with use of the power adaptor. If the instrument still doesn't work, please contact UNI-T for the service.

The Oscilloscope turns off a few seconds later after powered on:

The battery may run out. Check if the low battery indicator appears on the screen. If it does, please recharge it.

Measuring voltage amplitude is 10 times larger or smaller than exact value:

Make sure channel attenuation factor is consistent with probe factor on the applied probe.

No waveform displays after acquiring signals:

1. Make sure the probe is properly connected to the connection wire.
2. Make sure the connection wire is correctly attached to BNC (channel connector)
3. Make sure the probe is properly connected to the tested object.
4. Make sure there are signals generated from the tested object (you can connect the channel that can produce signals to the suspected channel and verify the cause)
5. Restart the acquisition

The waveform does not display steadily:

1. Check if trigger source that has been set up in trigger menu is the same with actual input channel
2. Check trigger type: Edge type is generally selected for common signals, use video trigger type for video signals. Only when proper trigger

type has been set up can the waveform display steady.

3. Try to change Coupling to HF Reject to filter out the high-frequency interference noise in the signal.

There is no display after pressing down RUN/STOP button:

1. Check if Trigger Mode in trigger menu is Normal or Single and trigger level has gone beyond waveform ranges. If they are, set trigger level to the middle or set trigger Mode to **AUTO**
2. Or you can press **AUTO** to automatically finish the setup mentioned above.

The display slows down after having applied AVG mode for a while:

1. If AVG number go above 32times, it is normal for the oscilloscopes to display at a relatively low rate.

2. Reduce AVG number

The waveform display has a stair-stepping shape:

1. It is normal situation, it may be caused by lower horizontal timebase, increasing the timebase can improve the horizontal resolution and the display
2. If display type is **VECTOR**, links between sample points could probably result in stair-stepping shape. Change display type to Dots can solve the problem.

Chapter 8 Service and Support

Updating Program

Contact UNI-T or log into our website to obtain the latest program package, unzip the package and apply the Oscilloscope program update system to update the Oscilloscope so as to ensure your oscilloscope has the latest version of firmware issued already by UNI-T

Preparation before Update

1. Turn on your oscilloscope, press CONFIGURE button and select system information option so as to obtain details about the Oscilloscope model, hardware version, software version, etc.
2. Make sure the program package you get from UNI-T company or website has the same model number and hardware version with the Oscilloscope to be updated. The version should be higher than the current version.

Update Conditions

1. The update program must have the same product model with that of your oscilloscope.

2. The update program must be consistent with your oscilloscope on hardware version
3. The update program version must be higher than or equal to that of your oscilloscope.

Program Update

1. Properly install the Oscilloscope software into your PC as instructed in communication software users manual
2. Copy the program package(extension is .upp) into PC. You can download from UNI-T website and contact UNI-T company directly to get the package.
3. Connect the Oscilloscope to PC with USB cable, then click to run the software, choose corresponding oscilloscope model and click **【ENTER】** in pop-up interface, the software interface will appear. Click **【Connect】** button on the interface to begin communication between PC and the Oscilloscope. With this connection finished, there will be an indication that USB has been connected successfully.

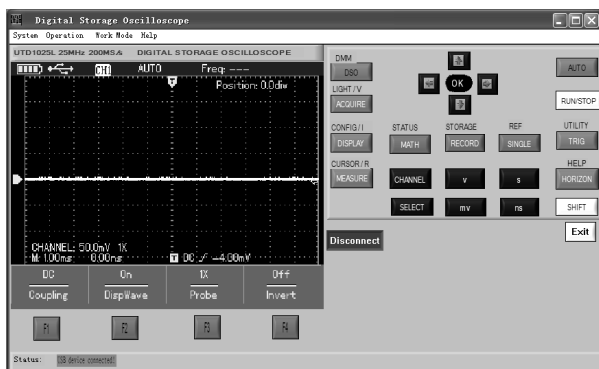

Figure 8-1 Connect to PC

4. Choose from the software menu **【Action】** → **【Program Update】**, then select the copied program package on dialogue box and confirm OK. The Oscilloscope then begins the update and reads “The Oscilloscope is preparing the update, please wait...”

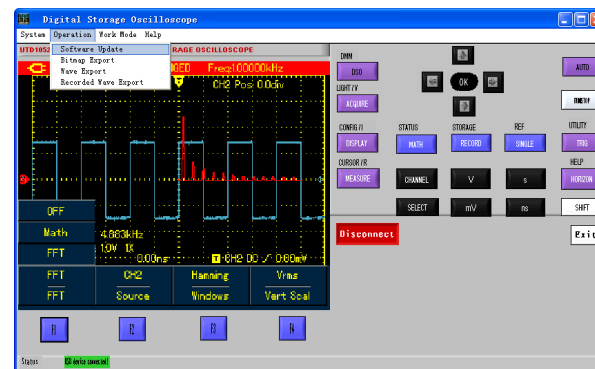

Figure 8-2 Program Update

5. The Oscilloscope will read “update has succeeded!” on the screen after the update has finished. Do not do any operation on the Oscilloscope at the moment, please repower it on to complete the program update.

Notes:

1. When the program package doesn't adapt to the Oscilloscope, PC reads "the update file is incorrect, please check!", then the Oscilloscope then stops the update and keeps the previous program version unchanged.
2. If the Oscilloscope was disconnected to PC or powered off or PC has been shut down during update, the update would stop and leave the previous program unchanged.

Chapter 9 Appendixes

Appendix A: Technical Specifications

Unless otherwise specified, the technical specifications are all applicable for 10× probe and UTD1025L Oscilloscope. First of all, the Oscilloscope must satisfy two following conditions in order to meet those specifications:

- The Oscilloscope must run continuously for more than 30 minutes in regulated working temperature.
- Users have to execute “self-calibration” procedure in UTILITY menu if operating temperature is 5°C or above higher than specified range. All specifications are warranted except items marked with “Typical”

Technical Specifications:

Oscilloscope

Acquisition mode	
Acquisition mode	Real-time acquisition
Acquisition rate	UTD1025CL UTD1050CL 200MS/s UTD1025DL UTD1050DL 250MS/s
Acquisition	Acquisition, Peak Detect, AVG, Fast Acquisition (UTD1000DL)
AVG value	All channels can acquire simultaneously up to N times, N can be selected from 2, 4, 8, 16, 32, 64, 128 and 256

Input	
Input Coupling	DC、AC、GND
Input Impedance	1 ±2%MQ, 21 ±3PF in parallel;
Probe Attenuation Factor	1X,10X,100X,1000X
Max.Input Voltage	300V (DC+AC Peak,、 1MQInput Impedance)
Interchannel Delay (typical)	50ps

Horizontal	
Waveform Interpolation	sin(x)/x
Record Length	UTD1000CL:1.5M ,UTD1000DL 3M
Memory Depth	12K
Max.Input Voltage	UTD1025CL UTD1025DL :10ns/div-50s/div UTD1050CL UTD1050DL :5ns div 50s div Stepping in 1-2-5
Sample Rate and Delay . Accuracy	±50ppm((any time interval ≥1ms)
Interval Time(Δ ÷ Measuring Accuracy (Full BW)	SINGLE : ± (1 sampling interval time ±50ppmXreadings ±0 6ns > 16AVGs : ± (1 sampling interval time ±100ppmXreadings±0 4ns)

Vertical	
A/D Converter(A/D)	8-bit resolution
Vertical Scale(V/div)	5mV/div~20V/div (at BNC prt)
Offset Ranges	5mV/div~100mV/div: $\pm 1.2V$; 200mV/div~1V/div: $\pm 24V$; 2V/div~20V/div: $\pm 240V$;
Analog Bandwidth	UTD1025CL UTD1025DL: 25MHz; UTD1050CL UTD1050DL: 50MHz
LF Response (AC Coupled ,3dB)	$\leq 10Hz$ (at BNC)
Rise Time	UTD1025CL UTD1025DL: $\leq 14ns$; UTD1050CL UTD1050DL $\leq 7ns$
DC Gain Accuracy	For vertical Sensitivity 5mV/div: $\pm 4\%$ (Normal or AVG) vertical Sensitivity from 10mV/div~20V/div: $\pm 3\%$ (Normal or AVG)
DC Measurement Accuracy(AVG mode)	Where vertical offset equals zero and $N \geq 16$: $\pm 4\% \times \text{Readings} + 0.1 \text{div} + 1 \text{ mV}$) and select 5mV/div ; $\pm 3\% \times \text{Readings} + 0.1 \text{div} + 1 \text{mV}$) and select 10mV/div~20V/div; $\pm 3\% \times \text{Readings} + 0.1 \text{div} + 1 \text{mV}$) and select bewteen 10mV/div~20V/div. Where vertical offset does not equal to zero and $N \geq 16$: $\pm 3\% \times (\text{Readings} + \text{Vertical offset value}) + (1\% \times \text{vertical offset Value})] \pm 0.2 \text{div}$ Add 2mV if setting between 5mV/div to 200mV/div; Add 50mV if settings from 200mV/div to 20V/div
Voltage Differnce($\Delta \div$) Measuring Accuracy(AVG Mode)	Under same settings and ambient conditions, calculate voltage difference(ΔV) between any two points just after capturing ≥ 16 wavforms and working out average values. Equation: $\pm 3\% \times \text{readings} + 0.05 \text{div}$

Trigger	
Trigger Sensitivity	≤1 div
Trigger Level Range	±10div from screen center point
Pre-Trigger	Normal/Sweep Mode, Pre-trigger/Delay Trigger, Pre-trigger Depth Adjustable
Hold-Off Range	100ns - 1.5s
Edge Trigger	
Edge Type	Rise , fall
Pulse Width Trigger	
Trigger Mode	(> , < , = , Positive Pulse Width , > (< , = , Negative Pulse Width
Pulse Width Range	20ns-10s
Video Trigger	
Trigger Sensitivity (Video , typical	2divs Peak-to-Peak Value
Video Format and Line/Field Frequency	Support standard NTSC and PAL , line numbers from 1~525 (NTSC and 1~625(PAL)
Slope Trigger	
Trigger Conditions	< , > =
Slew Rate	40pV/μs~1.6kV/μs

Measurements		
Cursor	Manual Mode	Cursor Voltage Difference(ΔV), Cursor Time Difference(ΔT), ΔT reciprocal(Hz)($1/\Delta T$)
	Auto Mode	Cursor allowed to display in auto mode
Auto Measurements		UTD1000CL: Peak to Peak Amplitude Max, Min, Top Point, Bottom Point, Middle, AVG, RMS Overshoot, Preshoot, Frequency, period, Rise Time, Fall Time, Positive & Negative Pulse Width, Positive & Negative Duty Cycle, total 19 types UTD1000DL: apart from 19 types the model offer another three parameters: Rise Delay, Fall Delay, Phase
Customized Parameter Measurement		Up to 4 types at a time
Mathematics		UTD1000CL: FFT ; UTD1000DL Math and FFT
Storage		Screens: 10sets; Waveforms: 20 sets, Settings: 20 types,
Waveform Recording		Store 5 sets of waveform records. UTD1000CL: recording 300 screens; UTD1000DL recording 150 screens
FFT	Window	Hanning, Hamming, Blackman, Rectangular
	Sample Points	1024 points
NYQUIST Pattern (UTD1000DL)	Phase Difference	± 3 degrees

Multimeter

The specified accuracy is valid over the temperature range 18 to 28

Add 10 % of specified accuracy for each degree C below 18 or above 28

UTD1000L User Manual

DC Voltage:

Input Impedance : 10MΩ

Max.Input Voltage: DC400V 。

Range	Resolution	Accuracy
400.0mV	0.1mv	±(1%+5 digits)
4.000V	1mv	
40.00V	10mv	
400.0V	100mv	

AC Voltage:

Input Impedance: 10MΩ

Max.Input Voltage: 400V AC RMS

Frequency Range : 40Hz ~ 400Hz.

Display: RMS of sinewave

Range	Resolution	Accuracy
400.0mV	0.1mv	±(1.2%+5 digits)
4.000V	1mv	
40.00V	10mv	
400.0V	100mv	

UTD1000CL DC Current:

Max. Input DC Current: DC10A

Range	Resolution	Accuracy
350.0μA	0.1μA	±(1.2%+5 digits)
40.00mA	10μA	±(1%+5 digits)
400.0mA	0.1mA	
10.00A Measure with UT-M07 (10A current divider module)	10mA	±(1.5%+5 digits)

UTD1000CL AC Current

Max.Input AC Current: AC 10A RMS

Frequency Range : 40Hz ~ 400Hz

Range	Resolution	Accuracy
350.0μA	0.1μA	±(2%+5 digits)
40.00mA	10μA	±(1.5%+5 digits)
400.0mA	0.1mA	
10.00A Measure with UT-M07 (10A current divider module)	10mA	±(2.5%+5 digits)

UTD1000DL DC Current :

Max. Input DC Current : DC4A

Range	Resolution	Accuracy
999.9μA Measure with UT-M10 (mA current module)	0.1μA	±(1.2%+5digits)
40.00mA Measure with UT-M10 (mA current module)	10μA	±(1%+5digits)
400.0mA Measure with UT-M10 (mA current module)	0.1mA	
4.00A Measure with UT-M04 (4A current divider module)	10mA	±(1.5%+5digits)

UTD1000DL AC Current

Max.Input AC Current: AC 4A RMS

Frequency Range : 40Hz ~ 400Hz .

Range	Resolution	Accuracy
999.9μA Measure with UT-M10 (mA current module)	0.1μA	±(2%+5digits)
40.00mA Measure with UT-M10 (mA current module)	10μA	±(1.5%+5digits)
400.0mA Measure with UT-M10 (mA current module)	0.1mA	
4.00A Measure with UT-M04 (4A current divider module)	10mA	±(2.5%+5digits)

Resistance

Range	Resolution	Accuracy
400.0 Ω	0.1Ω	±(1.2%+5 digits)
4.000kΩ	1Ω	
40.00kΩ	10Ω	
400.0kΩ	100Ω	
4.000MΩ	1kΩ	±(1.5%+5 digits)
40.00MΩ	10kΩ	

Capacitance

Range	Resolution	Accuracy
51.20nF	10pF	±(3%+5digits)
512.0nF	100pF	
5.120uF	1nF	
51.20μF	10nF	
100μF	1μF	

Diode:

Voltage Readout: 0V~1.5V

Continuity Test:

Resistance value for discontinuity: >75Ω, the beeper doesn't sound

Resistance value for good circuit continuity: ≤70Ω, continuous beeping;

Display	
Display Type	3.5inch, TFT LCD
Display Resolution	320Horizontal ×RGB ×240 Vertical pixels
Display Color	Color/Black&White
Waveform Display Zone	Horizontal: 12div, 25dot/div; Vertical: 8div, 25dot/div
Backlight Brightness	Adjustable
Backlight Intensity	300nit
Language	Multilingual

Interface	
Standard	UTD1000CL.UT M07(10A current divider module), 1pcs, one USB cable UTD1000DL.UT M04 4A current divider module), 1pcs, one UT-M10(mA current module), 1pcs, USB cable 1pcs
Optional	— — —

Power Adaptor	
Mains Voltage	100~220 V AC rms,45~440Hz
Output Voltage	9VDC
Output Current	4A

Battery:7.4 V 3600mA rechargeable lithium

batter;UTD1000CL 8 hour battery life

UTD1000DL 6 hour battery life

Environment	
Temperature	Operating: 0℃ ~+40℃
	Non-operation: -20℃ ~+60℃
Cooling Method	Naturally cooled down
Humidity	+35℃ : ≤90%
	+35℃ ~ +40℃ : ≤60%
Altitude	Operating:3,000m
	Naturally cooled down 15,000m

Mechanic specifications		
Dimensions (Reference Data)	199mm×118mm×49mm	
Weight (Net Weight)	Packing not included	0.9kg
	Packing Included	2.3kg

IP Degree
IP2X

Calibration Period
one time for each year

Appendix B Maintenance

1. General Service

Do not store or place the Oscilloscope in places that may get its LCD exposed to direct sunshine for a long time. Do not let spray agent, liquid and solvent stick onto the Oscilloscope or probe so as to avoid any damage to the Oscilloscope or probe

Cleaning

Check the Oscilloscope and its probe as actual operation requires. Clean the Oscilloscope surface as follows:

1. Clean dust on the Oscilloscope and probe surface with soft cloth. Avoid any scratch to LCD transparent protective layer.
2. Clean with soft cloth damped with water or mild agent, no water drop is allowed to occur. Do not use any corrosives or abrasives. Disconnect the power supply before cleaning.

Warning: To avoid any short circuit or even personal injury resulted from residual water, please



make sure the Oscilloscope is totally dry before powering it on

2. Storing the Oscilloscope

To store the Oscilloscope for a long term, you need to charge the batteries before storing it.

3. Charging Batteries

The battery may not be fully charged during the delivery, it must take four hours to fully charge the battery. The battery can work for 8hours after full charge.

When powered by the battery, the Oscilloscope indicates battery working status on the upper part of screen. battery indicators may include:   And  con means there is only five minutes left before the Oscilloscope powers off. Please connect the power adaptor to the Oscilloscope if you want to charge the battery and use the Oscilloscope at the same time

Caution:

To avoid over-heating when charging the battery, environment temperature shouldn't exceed allowable rated value(0°C ~+40°C) .

Note:

There is no danger involved even the Oscilloscope has been connected to the charger for a long time, for instance, during the whole weekend, for the Oscilloscope can automatically switch into very slow charging status.

Replacing Lithium Battery Pack

The battery pack doesn't need the replacement under general circumstances. If necessary, please have the battery pack replaced by qualified personnel and use new battery with the same specifications.

This user manual may be revised without prior notice.

Copyright 2011 UNI-Trend Group Limited.
All rights reserved.

Address:

Rm 901, 9/F, Nanyang Plaza, 57 Hung To Road,
Kwun Tong, Kowloon, Hong Kong

Phone:(852) 2950 9168

Fax:(852) 2950 9303

Email:info@uni-trend.com

Website:www.uni-trend.com

Manufacturer: UNI-T Technology (Chengdu) Co.,
Ltd Add:

2F, Building D2, No.199, West District Avenue,
West High-tech

District, Chengdu City, Sichuan Province,
P.R.China